

NEC Enterprise Series

MultiSync[®] E900[™]

User's Manual

Contents	1
Quick Start	2-3
Controls	4-5
Recommended Use	6-7
Specifications	8
Features	9
Troubleshooting	10
References	11
Limited Warranty	12



NEC
NEC Technologies



WARNING



TO PREVENT FIRE OR SHOCK HAZARDS, DO NOT EXPOSE THIS UNIT TO RAIN OR MOISTURE. ALSO, DO NOT USE THIS UNIT'S POLARIZED PLUG WITH AN EXTENSION CORD RECEPTACLE OR OTHER OUTLETS UNLESS THE PRONGS CAN BE FULLY INSERTED.
REFRAIN FROM OPENING THE CABINET AS THERE ARE HIGH VOLTAGE COMPONENTS INSIDE. REFER SERVICING TO QUALIFIED SERVICE PERSONNEL.



CAUTION



RISK OF ELECTRIC SHOCK • DO NOT OPEN

CAUTION: TO REDUCE THE RISK OF ELECTRIC SHOCK, DO NOT REMOVE COVER (OR BACK). NO USER SERVICEABLE PARTS INSIDE. REFER SERVICING TO QUALIFIED SERVICE PERSONNEL.



This symbol warns user that uninsulated voltage within the unit may have sufficient magnitude to cause electric shock. Therefore, it is dangerous to make any kind of contact with any part inside this unit.



This symbol alerts the user that important literature concerning the operation and maintenance of this unit has been included. Therefore, it should be read carefully in order to avoid any problems.

Canadian Department of Communications Compliance Statement

DOC: This Class B digital apparatus meets all requirements of the Canadian Interference-Causing Equipment Regulations.

Cet appareil numérique de la classe B respecte toutes les exigences du Règlement sur le matériel brouiller du Canada.

C-UL: Bears the C-UL Mark and is in compliance with Canadian Safety Regulations according to C.S.A. 22.2 #950.

Ce produit porte la marque 'C-UL' et se conforme aux règlements de sûreté Canadiens selon CAN/CSA 22.2 No. 950.

FCC Information

- Use the attached specified cables with the JC-1941UMA color monitor so as not to interfere with radio and television reception.
 - Please use the supplied power cable or equivalent to ensure FCC compliance.
 - Shielded captive type signal cable.
Use of other cables and adapters may cause interference with radio and television reception.
- This equipment has been tested and found to comply with the limits for a Class B digital device, pursuant to part 15 of the FCC Rules. These limits are designed to provide reasonable protection against harmful interference in a residential installation. This equipment generates, uses, and can radiate radio frequency energy, and, if not installed and used in accordance with the instructions, may cause harmful interference to radio communications. However, there is no guarantee that interference will not occur in a particular installation. If this equipment does cause harmful interference to radio or television reception, which can be determined by turning the equipment off and on, the user is encouraged to try to correct the interference by one or more of the following measures:
 - Reorient or relocate the receiving antenna.
 - Increase the separation between the equipment and receiver.
 - Connect the equipment into an outlet on a circuit different from that to which the receiver is connected.
 - Consult your dealer or an experienced radio/TV technician for help.

If necessary, the user should contact the dealer or an experienced radio/television technician for additional suggestions. The user may find the following booklet, prepared by the Federal Communications Commission, helpful: "How to Identify and Resolve Radio-TV Interference Problems." This booklet is available from the U.S. Government Printing Office, Washington, D.C., 20402, Stock No. 004-000-00345-4.

Contents

Your new NEC Technologies MultiSync® E Series monitor box* should contain the following:

- MultiSync E900™ (JC-1941UMA) Monitor with tilt/swivel base
- Power Cord
- Captive Signal Cable
- User's Manual
- Registration Card

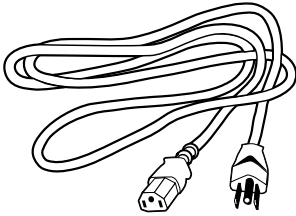

Power Cord

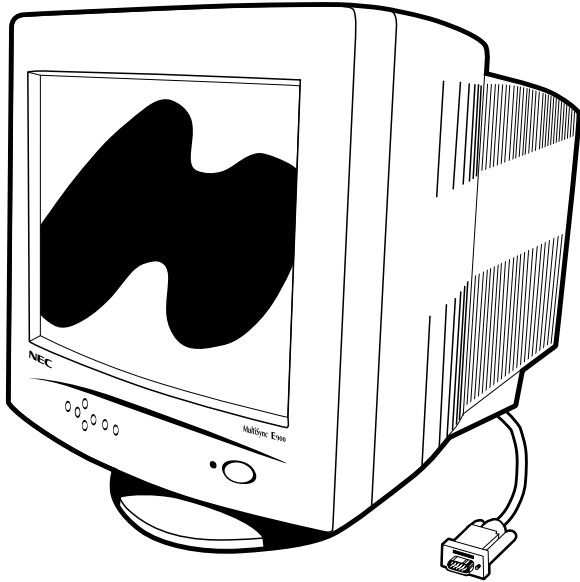

Captive Signal Cable



User's Manual

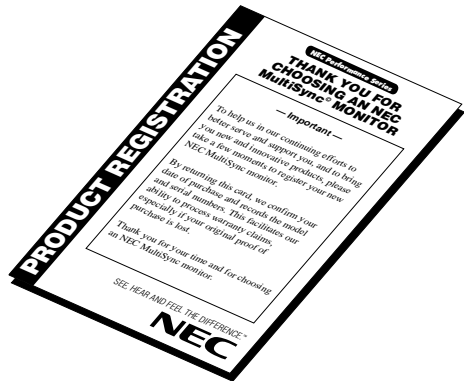

Registration Card

* Remember to save your original box and packing material to transport or ship the monitor.

Note: You can now register your product on the Internet at <http://www.prodreg.com/nec>



Quick Start

To attach the MultiSync® E900™ monitor to your system, follow these instructions:

1. Turn off the power to your computer.
2. If necessary, install the display card into your system. For more information, refer to the display card manual.
3. For the PC: Connect the 15-pin mini D-SUB of the captive signal cable to the connector of the display card in your system (Figure A.1). Tighten all screws.
For the Mac: Connect the MultiSync E900 Macintosh cable adapter (not included) to the monitor connector on the Macintosh (Figure B.1). Attach the 15-pin mini D-SUB end of the captive signal cable to the MultiSync E900 Macintosh cable adapter on the computer (Figure B.1). Tighten all screws.

NOTE: To obtain the MultiSync E900 Macintosh cable adapter, call NEC Technologies at (800) 820-1230.

4. Connect one end of the power cord to the MultiSync E900 monitor and the other end to the power outlet (Figure C.1).
5. Turn on the monitor (Figure D.1) and the computer.

NOTE: If you have any problems, please refer to the **Troubleshooting** section of this User's Manual.

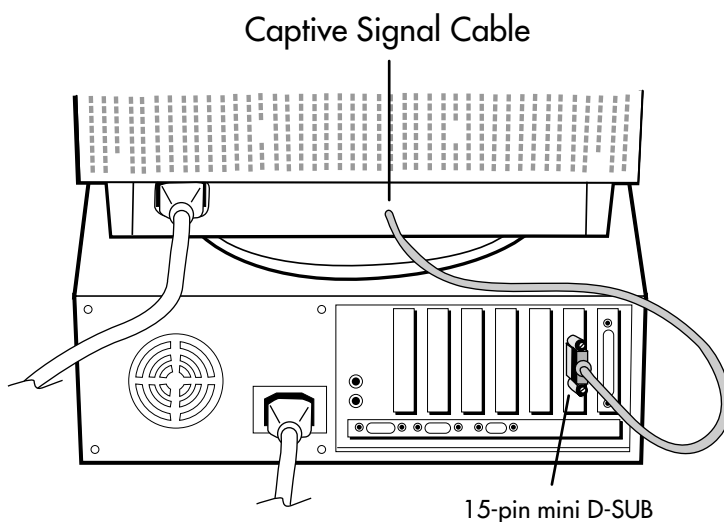

Figure A.1

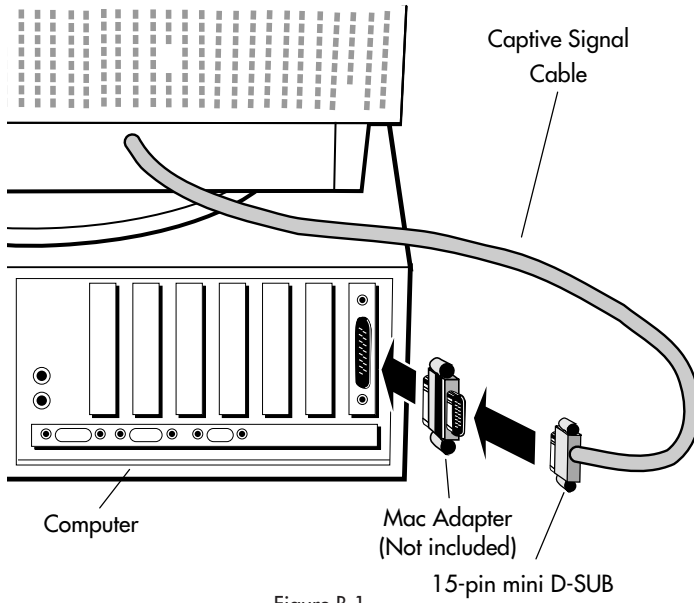

Figure B.1

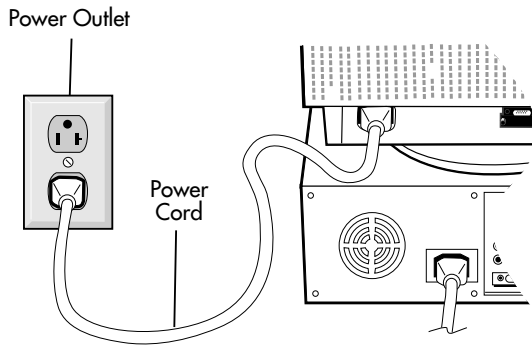

Figure C.1

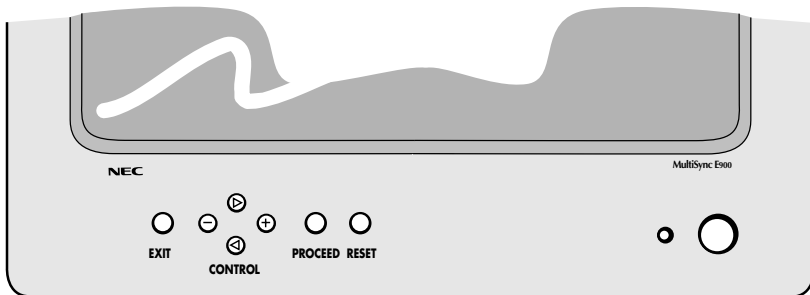







Figure D.1





Controls





OSM™ (On-Screen Manager) control buttons on the front of the monitor function as follows:

- EXIT**  Exits the OSM controls.
- CONTROL**   Moves the highlighted area left/right to select one of the controls.
- CONTROL**  **+/-** Moves the bar in the + or - direction to increase or decrease the adjustment.
- PROCEED**  Enters OSM menu and selects icons at the top of the menu.
- RESET**  Resets the highlighted control to the factory setting.

Brightness/Contrast Controls





-  Adjusts the overall image and background screen brightness.
-  Adjusts the image brightness in relation to the background.

Size and Position Controls

-  Moves the image horizontally (left or right).
-  Moves the image vertically (up or down).
-  Increases or decreases the horizontal size of the image.
-  Increases or decreases the vertical size of the image.

Geometry Controls

The **Geometry** controls allow you to adjust the curvature or angle of the sides of your display.

-  Increases or decreases the curvature of the sides either inward or outward.
-  Increases or decreases the curvature of the sides either to the left or right.
-  Increases or decreases the tilt of the sides either to the left or right.
-  Increases or decreases the top of the screen to be the same as the bottom.
-  Rotates the entire display clockwise or counterclockwise

Color Control/AccuColor® Control System

Two color presets select the desired color setting. Each color setting is adjusted at the factory to the stated degree Kelvin.



Tools 1



Reduces horizontal moire patterns.



Reduces vertical moire patterns.



Tools 2



Degauss Control: Eliminates the buildup of stray magnetic fields that alter the correct scan of the electron beams and affect the purity of the screen colors, focus and convergence. When activated, your screen image will jump and waver a bit as the screen is demagnetized.

Caution: Please allow a minimum of 20 minutes to elapse between uses of the Degauss Control.



Indicates the frequency setting of the monitor.



IPM™ System: On: The IPM System works normally and all stages of energy savings are utilized.

Off: The Off Mode of the IPM System is not used.

NOTE: For standard systems and graphics boards, keep the factory setting at **ON**.



Selecting **ALL RESET** allows you to reset all OSM™ control settings back to the factory settings **except IPM System**. Individual settings can be reset by highlighting the control to be reset and pressing the **RESET** button.



Recommended Use

Safety Precautions and Maintenance



FOR OPTIMUM PERFORMANCE, PLEASE NOTE THE FOLLOWING WHEN SETTING UP AND USING THE MULTISYNC® E900™ COLOR MONITOR:



- **DO NOT OPEN THE MONITOR.** There are no user serviceable parts inside and opening or removing covers may expose you to dangerous shock hazards or other risks. Refer all servicing to qualified service personnel.
- Allow adequate ventilation around the monitor so that heat can properly dissipate. Do not block ventilated openings or place the monitor near a radiator or other heat sources. Do not put anything on top of monitor.
- Do not spill any liquids into the cabinet or use your monitor near water.
- Do not insert objects of any kind into the cabinet slots, as they may touch dangerous voltage points, which can be harmful or fatal or may cause electric shock, fire or equipment failure.
- Do not place any heavy objects on the power cord. Damage to the cord may cause shock or fire.
- Do not place this product on a sloping or unstable cart, stand or table, as the monitor may fall, causing serious damage to the monitor.
- Keep the monitor away from high capacity transformers, electric motors and other devices such as external speakers or fans, which may create strong magnetic fields.
- If possible, position the monitor so that it is facing the east to minimize the effects of the earth's magnetic field.
- Changing the direction of the monitor while it is powered on may cause image discoloration. To correct this, turn the monitor off for 20 minutes before powering it back on.
- When operating the MultiSync E900 with its AC 220-240V worldwide power supply, use a power supply cord that matches the power supply voltage of the AC power outlet being used. The power supply cord you use must have been approved by and comply with the safety standards of your country.
- The power cable connector is the primary means of detaching the system from the power supply. The monitor should be installed close to a power outlet which is easily accessible.
- Handle with care when transporting. Save packaging for transporting.

Immediately unplug your monitor from the wall outlet and refer servicing to qualified service personnel under the following conditions:

- When the power supply cord or plug is damaged.
- If liquid has been spilled, or objects have fallen into the monitor.
- If the monitor has been exposed to rain or water.
- If the monitor has been dropped or the cabinet damaged.
- If the monitor does not operate normally by following operating instructions.





CORRECT PLACEMENT AND ADJUSTMENT OF THE MONITOR CAN REDUCE EYE, SHOULDER AND NECK FATIGUE. CHECK THE FOLLOWING WHEN YOU POSITION THE MONITOR:

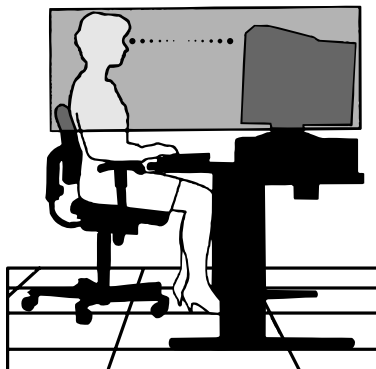

- Adjust the monitor height so that the top of the screen is at or slightly below eye level. Your eyes should look slightly downward when viewing the middle of the screen.
- Position your monitor no closer than 12 inches and no further away than 28 inches from your eyes. The optimal distance is 18 inches.
- Rest your eyes periodically by focusing on an object at least 20 feet away. Blink often.
- Position the monitor at a 90° angle to windows and other light sources to minimize glare and reflections. Adjust the monitor tilt so that ceiling lights do not reflect on your screen.
- If reflected light makes it hard for you to see your screen, use an anti-glare filter.
- Clean your monitor regularly. Use a lint-free, non-abrasive cloth and a non-alcohol, neutral, non-abrasive cleaning solution or glass cleaner to minimize dust.
- Adjust the monitor's brightness and contrast controls to enhance readability.
- Use a document holder placed close to the screen.
- Position whatever you are looking at most of the time (the screen or reference material) directly in front of you to minimize turning your head while you are typing.
- Get regular eye checkups.

For more detailed information on setting up a healthy work environment, call NEC at (800) 820-1230, NEC FastFacts™ information at (800) 366-0476 and request document #900108 or write the American National Standard for Human Factors Engineering of Visual Display Terminal Workstations – ANSI-HFS Standard No. 100-1988 – The Human Factors Society, Inc. P.O. Box 1369, Santa Monica, California 90406.

Specifications

Monitor Specifications	MultiSync® E90™ Monitor	Notes
Picture Tube Viewable Image Size: Radius:	Diagonal: 19 inch 18.0 inch Radius: 1330 mm	90° deflection, 0.28 mm trio dot pitch, medium short persistence phosphor, multi-layered, anti-static screen coating, semi-tint screen, Invar Shadow Mask and OptiClear® screen surface.
Input Signal	Video: Sync: ANALOG 0.7 Vp-p/75 Ohms Separate sync. TTL Level Horizontal sync. Positive/Negative Vertical sync. Positive/Negative Composite sync. (Positive/Negative) (TTL Level)	
Display Colors	Analog input: Unlimited number of Colors	Depends on display card used.
Synchronization Range	Horizontal: Vertical: 31 kHz to 92 kHz 55 Hz to 120 Hz	Automatically Automatically
Resolutions Supported Resolution based on horizontal and vertical frequencies only	640 x 480 @ 55 to 120 Hz 800 x 600 @ 55 to 120 Hz 832 x 624 @ 55 to 120 Hz 1024 x 768 @ 55 to 112 Hz 1280 x 1024 @ 55 to 85 Hz 1600 x 1200 @ 55 to 73 Hz	Some systems may not support all modes listed. NEC cites recommended resolution at 85 Hz for optimal display performance
Active Display Area (Factory Setting)	Horizontal: Vertical: 356 mm/14.0 inches 267 mm/10.5 inches	Dependent upon signal timing used, and does not include border area.
Active Display Area (Full Scan)	360 mm/14.2 inches 270 mm/10.6 inches	Dependent upon signal timing used, and does not include border area.
Power Supply	AC 100 – 120 V/220 - 240 V@, 50/60 Hz	
Current Rating	2.0A @ 100 – 120 V/1.0A@ 220-240 V	
Dimensions	447 mm (W) x 462 mm (H) x 479 mm (D) 17.6 inches (W) x 18.2 inches (H) x 18.9 inches (D)	
Weight	23.5 kg 51.8 lbs	
Environmental Considerations	Operating Temperature: Humidity: Feet: Storage Temperature: Humidity: Feet: 0°C to +35°C 30% to 80% 0 to 10,000 Feet -20°C to +60°C 10% to 90% 0 to 45,000 Feet	

NOTE: Technical specifications are subject to change without notice.



Features

OptiClear® Screen Surface: Reduces reflection and glare and increases contrast without sacrificing focus level, clarity or brightness. Along with the flat square technology CRT, a high contrast screen with 0.28 mm trio dot pitch delivers crisp, clean text and graphics.

Invar Shadow Mask: Holes in the thin metal sheet behind the glass of the CRT surface correspond to each phosphor dot on the inner surface of the CRT's faceplate, allowing the correct electron beam (red, green, blue) to hit the correct color phosphor for improved focus, brightness and color.

Dual Dynamic Beam Focus: Provides precise, continuous focus adjustments of the electron beams and optimum image quality, even to the far edges of the screen.

AccuColor® Control System: Allows you to change between two color settings on your display to match your personal preference.

OSM™ (On-Screen Manager) Controls: Allow you to quickly and easily adjust all elements of your screen image via simple to use on-screen menus.

ErgoDesign® Features: Enhance human ergonomics to improve the working environment, protect the health of the user and save money. Examples include OSM controls for quick and easy image adjustments, tilt/swivel base for preferred angle of vision and compliance with MPRII guidelines for lower emissions.

Plug and Play: The Microsoft® solution with the Windows®95 operating system facilitates setup and installation by allowing the monitor to send its capabilities (such as screen size and resolutions supported) directly to your computer, automatically optimizing display performance.

IPM™ (Intelligent Power Manager) System: Provides innovative power-saving methods that allow the monitor to shift to a lower power consumption level when on but not in use, saving two-thirds of your monitor energy costs, reducing emissions and lowering the air conditioning costs of the workplace.

Reduced Magnetic Field™ Technology: Reduces magnetic and alternating electric field emissions and static electricity, addressing ergonomic concerns regarding potential risks from extended computer monitor use.

Multiple Frequency Technology: Automatically adjusts monitor to the display card's scanning frequency, thus displaying the resolution required.

FullScan™ Capability: Allows you to use the entire screen area in most resolutions, significantly expanding image size.

OSM Display Screen Copyright 1998 by NEC Technologies, Inc.



Troubleshooting

No picture

- Display card should be completely seated in its slot.
- Power Button and computer power switch should be in the ON position.
- Signal cable should be completely connected to display card/computer.
- Check connector for bent or pushed-in pins.

Image is scrolling or unstable

- Signal cable should be completely attached to the computer.
- Check pin assignments and signal timings of the monitor and your display card with respect to recommended timings and pin assignments.
- If the Macintosh cable adapter is used, check for prior connection or make sure the display card is Macintosh compatible and that the card is properly seated in the computer.

LED on monitor is not lit *(no green, orange, yellow color can be seen)*

- Power Switch should be in the ON position and power cord should be connected.

Picture is fuzzy or color looks blotchy

- Adjust Brightness and Contrast Controls.
- Access the Degauss Control through OSM™ controls. Activate the Degauss Control.

CAUTION: A minimum interval of 20 minutes should elapse before the Degauss Control is used a second time when not switching between modes.

Picture bounces or a wavy pattern is present in the picture

- Move electrical devices that may be causing electrical interference away from the monitor.
- See inside cover of User's Manual for FCC information.

Edges of the display image are not square

- Use the OSM Geometry Controls to straighten the edges.
- If possible, position the front of the monitor facing east.

Display image is not centered, too small, or too large

- Use the OSM Size and Position Controls to adjust the image.



References

- **BBS (978) 635-4706**

NEC Technologies' Remote Bulletin Board System is an electronic service accessible with your system and a modem. Communication parameters are: 300/1200/2400/9600/14.4k/28.8k bps, no parity, 8-data bits, 1 stop bit

- **Customer Service/ Technical Support (800) 632-4662**
Fax (978) 635-4298

- **Electronic Channels:**

Internet e-mail: tech-support@necotech.com
 Internet ftp site: <ftp.necotech.com>
 CompuServe: go NECTECH
 World Wide Web: <http://www.nec.com>

- **FastFacts™ Information (800) 366-0476**

INFORMATION	DESCRIPTION	DOCUMENT #
MultiSync® E900™ monitor	Detailed monitor information	194101
Glossary	Definition of terms related to functions, features and installation of the MultiSync monitor	900203
More Information	Names and addresses of other groups involved in standards and features of the MultiSync monitor	900204
Macintosh Connection	Detailed information on connecting the MultiSync monitor to a Macintosh	153006
Healthy Work Environment	Detailed information on setting up a healthy work environment	900108

- **Literature & Sales Info (800) NEC-INFO [(800) 632-4636]**

- **MultiSync Fulfillment (800) 820-1230**
 [For software & accessories]

- **TeleSales (800) 284-4484**



Limited Warranty

NEC Technologies, Inc. (hereinafter "NECTECH"), warrants this Product to be free from defects in material and workmanship and, subject to the conditions set forth below, agrees to repair or replace any part of the enclosed unit which proves defective for a period of three (3) years from the date of first consumer purchase. Spare parts are warranted for ninety (90) days.

This warranty gives you specific legal rights and you may also have other rights which vary from state to state. This warranty is limited to the original purchaser of the Product and is not transferable. This warranty covers only NECTECH-supplied components. Service required as a result of third party components is not covered under this warranty. In order to be covered under this warranty, the Product must have been purchased in the U.S.A. or Canada by the original purchaser. This warranty only covers Product distribution in the U.S.A. or Canada by NECTECH. Any use or installation outside the U.S.A. or Canada will void this warranty. Proof of Purchase will be required by NECTECH to substantiate date of purchase. Such proof of purchase must be an original bill of sale or receipt containing name and address of seller, purchaser, and the serial number of the product.

It shall be your obligation and expense to have the Product shipped, freight prepaid, or delivered to the authorized reseller from whom it was purchased or other facility authorized by NECTECH to render the services provided hereunder in either the original package or a similar package affording an equal degree of protection. All Products returned to NECTECH for service MUST have prior approval, which may be obtained by calling 1-800-632-4662.

The Product shall not have been previously altered, repaired, or serviced by anyone other than a service facility authorized by NECTECH to render such service, the serial number of the product shall not have been altered or removed. In order to be covered by this warranty the Product shall not have been subjected to displaying of fixed images for long periods of time resulting in image persistence (afterimage effects), accident, misuse or abuse or operated contrary to the instructions contained in the User's Manual. Any such conditions will void this warranty.

NECTECH SHALL NOT BE LIABLE FOR DIRECT, INDIRECT, INCIDENTAL, CONSEQUENTIAL, OR OTHER TYPES OF DAMAGES RESULTING FROM THE USE OF ANY NECTECH PRODUCT OTHER THAN THE LIABILITY STATED ABOVE. THESE WARRANTIES ARE IN LIEU OF ALL OTHER WARRANTIES EXPRESS OR IMPLIED, INCLUDING, BUT NOT LIMITED TO, THE IMPLIED WARRANTIES OF MERCHANTABILITY OR FITNESS FOR A PARTICULAR PURPOSE. SOME STATES DO NOT ALLOW THE EXCLUSION OF IMPLIED WARRANTIES OR THE LIMITATION OR EXCLUSION OF LIABILITY FOR INCIDENTAL OR CONSEQUENTIAL DAMAGES SO THE ABOVE EXCLUSIONS OR LIMITATIONS MAY NOT APPLY TO YOU.

This Product is warranted in accordance with the terms of this limited warranty. Consumers are cautioned that Product performance is affected by system configuration, software, the application, customer data, and operator control of the system, among other factors. While NECTECH Products are considered to be compatible with many systems, specific functional implementation by the customers of the Product may vary. Therefore, suitability of a Product for a specific purpose or application must be determined by consumer and is not warranted by NECTECH.

For the name of your nearest authorized NECTECH service facility, contact NECTECH at 1-800-632-4662.





Notes





NEC Enterprise Series

PROPRIETARY NOTICE AND LIABILITY DISCLAIMER

The information disclosed in this document, including all designs and related materials, is the valuable property of NEC Technologies and/or its licensors, as appropriate, reserve all patent, copyright and other proprietary rights to this document, including all design, manufacturing, reproduction, use and sales rights thereto, except to the extent said rights are expressly granted to others.

The NEC Technologies product(s) discussed in this document are warranted in accordance with the terms of the Limited Warranty Statement accompanying each product. However, actual performance of each such product is dependent upon factors such as system configuration, customer data and operator control. Since implementation by customers of each product may vary, the suitability of specific product configurations and applications must be determined by the customer and is not warranted by NEC Technologies.

To allow for design and specification improvements, the information in this document is subject to change at any time without notice. Reproduction of this document or portions thereof without prior approval of NEC Technologies is prohibited.

DECLARATION OF CONFORMITY

This device complies with Part 15 of FCC Rules. Operation is subject to the following two conditions. (1) This device may not cause harmful interference, and (2) this device must accept any interference received, including interference that may cause undesired operation.

U.S. Responsible Party: NEC Technologies, Inc. Address: 1250 N. Arlington Heights Road, Suite 500 Itasca, Illinois 60143 Tel. No.: (630) 467-5000

Type of Product:	Computer Monitor
Equipment Classification:	Class B Peripheral
Models:	JC-1941UMA



We hereby declare that the equipment specified above conforms to the technical standards as specified in the FCC Rules.

MultiSync is a registered trademark of NEC Technologies, Inc. in the U.S. and of NEC Home Electronics, Ltd. in Canada, UK, Germany, France, Spain, Italy, Austria, Benelux, Switzerland, Denmark, Finland, Norway and Saudi Arabia. AccuColor, OptiClear and ErgoDesign are registered trademarks of NEC Technologies, Inc. in the U.S. and Canada. E900, Reduced Magnetic Field, IPM, FastFacts, FullScan and OSM are trademarks of NEC Technologies, Inc. in the U.S. NEC is a registered trademark of NEC Corporation Copyright 1998 by NEC Technologies, Inc. OSM Display Screens Copyright 1998 by NEC Technologies, Inc. Windows is a registered trademark of Microsoft Corporation. All other brands and product names are trademarks or registered trademarks of their respective owners.

As an Energy Star Partner, NEC Technologies has determined that this product meets the Energy Star guidelines for energy efficiency. The Energy Star emblem does not represent EPA endorsement of any product or service.



NEC

NEC Technologies

Part No. 78133231
Printed in Malaysia

