

The information presented in this publication has been carefully checked for reliability; however, no responsibility is assumed for inaccuracies. Specifications are subject to change without notice.

## **Trademarks**

IBM, PC/AT, and PC/XT are trademarks of International Business Machines Corporation.

Intel and Pentium® II are trademarks of Intel Corporation.

AMI is a trademark of American Megatrends Inc.

MS-DOS and WINDOWS 95/98/NT are registered trademarks of Microsoft Corporation.

## Contents

<b>Chapter 1: Introduction</b> .....	<b>1</b>
Key Features .....	2
Unpacking the Mainboard & Static Electricity Precautions.....	4
<b>Chapter 2: Hardware Configuration</b> .....	<b>5</b>
CPU Installation .....	6
Installation Procedures.....	7
Mainboard Component Locations .....	10
Connectors.....	11
PWR1 – AT Power Connector.....	11
COM1/2 – Serial Port #1/ #2 .....	11
PRN1 – Parallel Printer Connector.....	11
FDC1 – Floppy Disk Drive Connector.....	11
IDE1/IDE2 – Primary/Secondary IDE Connectors .	11
KBD1 – Keyboard Connector .....	11
PS1/PS2 – PS/2 Mouse Pin Header/Connector .....	11
J4 – ATX Form Card Connector .....	11
J5 (2, 4, 6, 8, 10) (KEYLOCK) – Keylock & Power LED Connector.....	12
J5 (1, 3, 5, 7) (SPK) – Speaker Connector.....	12
J5 (13, 14) (TB-LED) – Turbo LED Connector .....	12
J5 (15, 16) (HDD-LED) – HDD LED Connector .....	13
J5 (17, 18) (RST) – Reset Switch Connector .....	13
J5 (19, 20) (SPDLED) – Suspend LED Connector .....	13
FAN-PWR – CPU Fan Connector .....	13
Sound Pro Connectors:.....	13
CD1/CD2 – Analog Audio for Sony/Panasonic .....	13
J3 – Sound and Game .....	14
J2 – Digital Audio IN .....	14
J1 – Digital Audio OUT .....	14
Jumper Settings .....	15
JP5 – DIMM Voltage Selectors .....	15
JP2 – Microphone Type Selector .....	15
JP1 – Sound Pro Selector .....	15
JP10 – CMOS RAM Clear Selector .....	16
JP7 – Frequency Selector .....	16
JP3 (A, B, C, D) – Multiplier Selectors .....	16
Memory Installation.....	17

<b>Chapter 3: ACPI Functions &amp; Connectors with ATX Power</b> .....	18
PWR2 – ATX Style Power Connector .....	18
Software Power-Off .....	19
Modem Ring Power-On .....	19
Alarm Wake Up .....	19
J5 (21, 22) (SUS-SW) – ATX Power Button and Suspend Switch Connector .....	20
<b>Chapter 4: BIOS Setup</b> .....	21
Entering BIOS Setup .....	22
Default .....	23
Load Optimal Settings .....	23
Load Best Performance Settings .....	23
Setup Items.....	23
Standard CMOS Setup .....	23
Advanced CMOS Setup .....	24
Advanced Chipset Setup .....	27
Power Management Setup.....	29
PCI/Plug and Play Setup.....	31
Peripheral Setup .....	32
Change Supervisor Password .....	34
Auto-Detect Hard Disks.....	34
Save Settings and Exit .....	34
Exit Without Saving.....	34



---

# Chapter 1

## Introduction

---

This mainboard is a **100MHz** high-performance mainboard based on the advanced Pentium® II microprocessor and featuring Accelerated Graphics Port (AGP) and the **high-end AGPset** chipset. The mainboard offers a high degree of flexibility in configuration and is fully IBM PC/AT compatible.

---

## Key Features

---

The advanced features of the mainboard include:

- Supports Pentium® II 233 ~ 450 and Celeron 266~333 MHz CPUs at Slot1 for AT Form Factor
- Provides 3 DIMMs for SDRAM/EDO/FPM memory modules and is expandable up to 384MB, however, it is not recommended to use EDO/FPM DRAM when 100MHz CPU frequency is being used and SDRAM has to meet the requirement of PC-100 if using 100MHz;
- Supports Accelerated Graphics Port (AGP) v1.0, 3 PCI, and 2 ISA slots
- Supports Advanced Configuration Power Interface (ACPI) and Legacy PMU and the Ultra DMA /33, fully compliant to PC97 and PC98
- Provides both AT/ATX power connectors, and supports various functions of ATX power, such as Suspend/Shutdown, Modem Ring On, and Alarm Wake Up
- Onboard PCI Bus Master IDE interface supports 4 IDE devices with 2 channels
- Onboard super Multi-I/O chip supports 2 serial ports with 16550 compatible fast UART, 1 parallel port with EPP and ECP capabilities, and one floppy disk drive interface with 1Mb/s transfer rate
- Provides **ATX Form Card** which containing PS/2 Mouse, 2 USB interface, and Infrared connectors
- System BIOS supports Trend's **ChipAway Virus** function to ensure the entire boot process is virus-free, no installation and configuration worries
- Bundled **PC-cillin97** (OEM) provides automatic Virus Protection for Windows 95/98 and the Internet

- **Onboard Sound Pro** supports the following features:
  - Sound Blaster 16/PRO compatible, HRTF 3D Positional Audio provide drivers for 3D games that use Aureal software interface
  - Windows Sound System V2.0 compatible, Accelerates Direct Sound 3D in Win95, and Windows 95/31 & DOS drivers supported
  - Supports 44.1K digital audio (SPDIF) IN/OUT, HSP-23 Wavetable synthesizer, full duplex 16-bits CODEC with filters, and high quality 3D sound (ON/OFF controllable)
  - Device supports SB16, WSS, & Game
  - Stereo Mixer supports analog mixing from CD-Audio & Line-In and digital mixing from Voice, FM/Wave-table, and digital CD-Audio.

---

## Unpacking the Mainboard & Static Electricity Precautions

---

This Mainboard package contains the following items:

1. This Mainboard and the Device Driver
2. The Slot1 holder and AT cable set
3. This User's Guide
4. Sound & Game ribbon cables/bracket and SPDIF/IN cable
5. ATX Form Card

The mainboard is easily damaged by static electricity. Follow the precautions below while unpacking or installing the mainboard.

1. Do not remove the mainboard from its original package until you are ready to install it.
2. Frequently ground yourself to discharge any static electric charge that may build up in your body while working on installation and/or configuration. For example, you may ground yourself by grasping an unpainted portion of the system's metal chassis.
3. Remove the mainboard from its anti-static packaging and place it on a grounded surface, component side up.
4. Handle the mainboard by its edges or by the mounting bracket to avoid touching its components.
5. Check the mainboard for damage. If any integrated circuit appears loose, press carefully to seat it firmly in its socket.
6. Do not apply power if the mainboard appears damaged. If there is damage to the board contact your dealer immediately.



---

## **Chapter 2**

# **Hardware Configuration**

---

Before you install the mainboard into the system chassis, you may find it convenient to first configure the mainboard's hardware. This chapter describes how to set jumpers and install memory modules, and where to attach components.

## CPU Installation

This mainboard supports Intel Pentium® II CPU using a Single Edge Contact (SEC) slot. Make sure that you have the following items (which should be included in the package) before doing any installation. All parts are labeled here with item numbers which will be referred to in the Installation Procedures section. Item 1 and 2 together are the retention mechanism, please refer to following procedures to complete your CPU installation.

- 1) 4 screws:

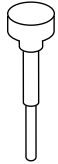

- 2) 1 retention clip:

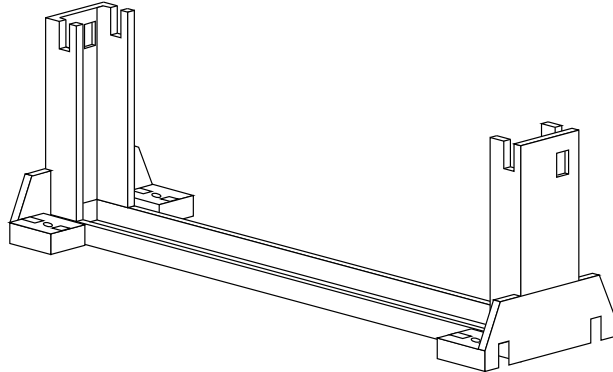

## Installation Procedures

Follow the following steps in order to install your Intel Pentium® II properly.

### Step 1:

Make sure that the mainboard is set the same direction as the following drawing before doing any installation.

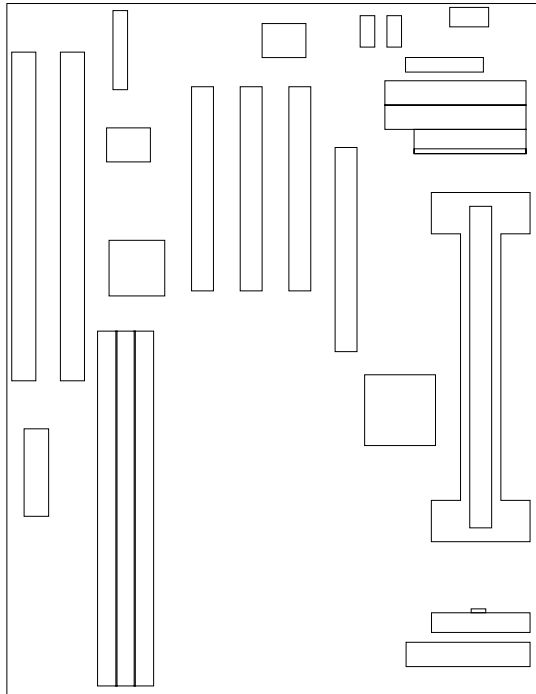

**Step 2:**

There are 2 sets of small holes along Slot 1 of your mother board: two on the top and two on the bottom. Snap the retention clip (2) right into those 2 sets of holes

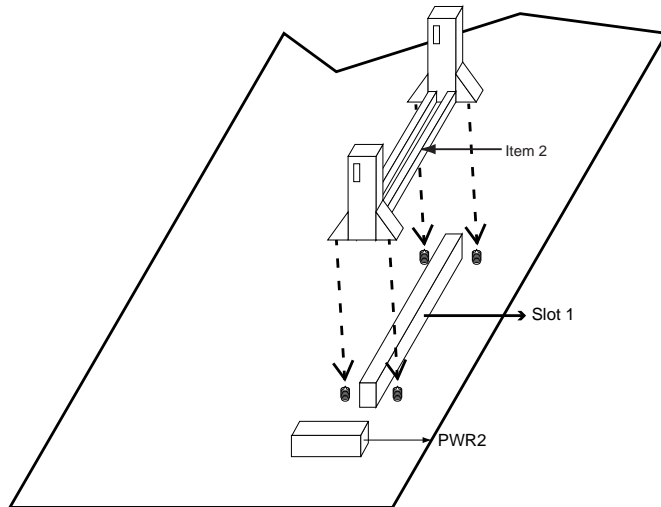

If the retention clip is installed incorrectly, you will not be able to insert the retention clip into the CPU and in this situation you might need to rotate the retention clip by 180°.

**Step 3:**

Find the hole in each corner of the retention clip then insert the 4 screws from the top of the motherboard.

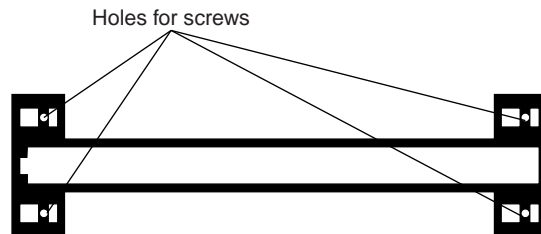

**Step 4:**

And then simply push the screws downward to secure the retention clip.

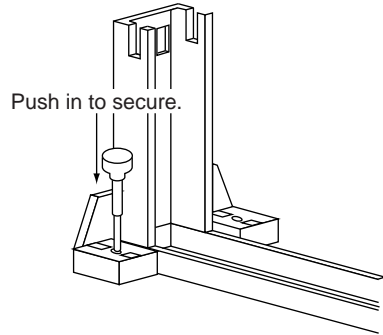

**Step 5:**

Flatten the two latches on the side of CPU. Insert the CPU into the retention clip. Lock the two latches to secure the CPU.

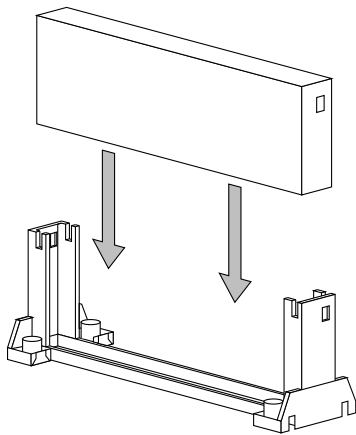

# Mainboard Component Locations

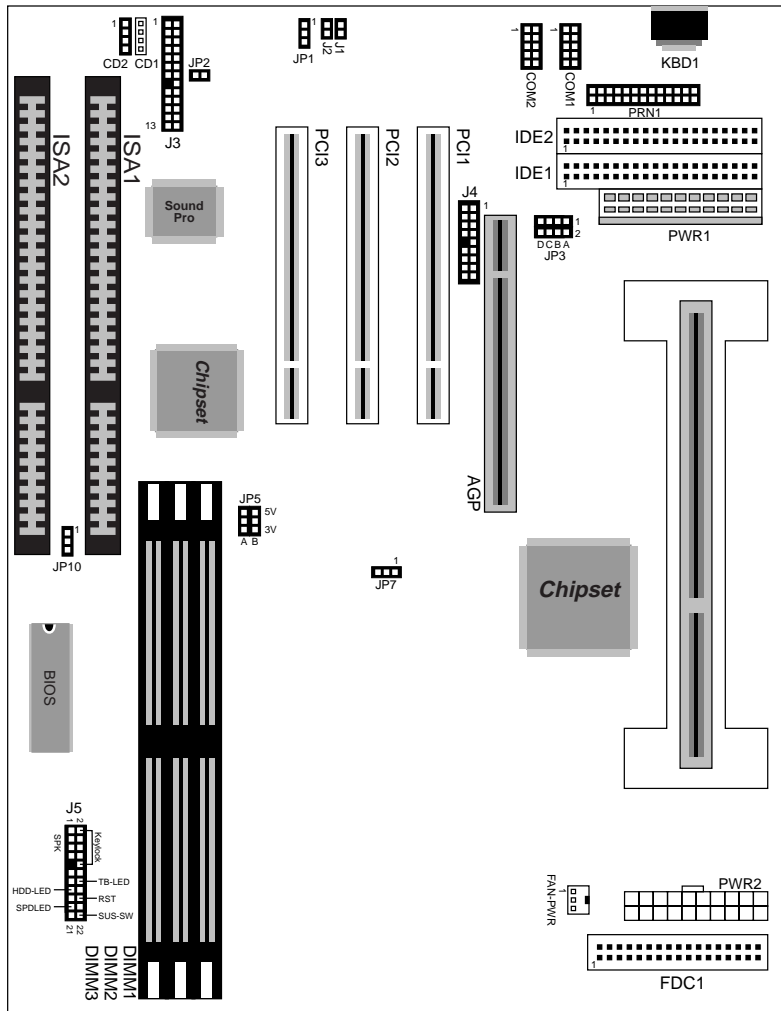

Figure 2-1. Mainboard Component Locations

---

## Connectors

---

Attach system components and case devices to the mainboard via the mainboard connectors. A description of each connector pins follows. See Figure 2-1 for the location of the connectors on the mainboard.

*Note: Make sure that the power is turned off before making any connection to the board.*

### **PWR1 – AT Power Connector**

### **COM1/2 – Serial Port #1/#2**

### **PRN1 – Parallel Printer Connector**

### **FDC1 – Floppy Disk Drive Connector**

### **IDE1/IDE2 – Primary/Secondary IDE Connectors**

### **KBD1 – Keyboard Connector**

### **J4 – ATX Form Card Connector**

This connector contains 2 sets of USB interface, PS/2 Mouse, and Infrared connectors. Connect the ATX Form Card cable to this connector.

**J5 (2, 4, 6, 8, 10) (KEYLOCK) – Keylock & Power LED Connector**

Keylock connector enables and disables the keyboard key-in function on the case.

Pin	Description
2	LED Output
4	N.C.
6	Ground
8	Keylock
10	Ground

**J5 (1, 3, 5, 7) (SPK) – Speaker Connector**

Pin	Description
1	Data Out
3	N.C.
5	Ground
7	+5V

**J5 (13, 14) (TB-LED) – Turbo LED Connector**

Pin	Description
13 (+)	+5V
14 (-)	Active Low



**J5 (15, 16) (HDD-LED) – HDD LED Connector**

Pin	Description
15 (+)	+5V
16 (-)	Active Low

**J5 (17, 18) (RST) – Reset Switch Connector**

Setting	Description
Open	Normal Mode
Close	Reset System

**J5 (19, 20) (SPDLED) – Suspend LED Connector**

Pin	Description
19 (+)	+5V
20 (-)	Active Low

**FAN-PWR – CPU Fan Connector****Sound Pro Connectors:****CD1/CD2 – Analog Audio for Panasonic/Sony**

Connect to "AUDIO" on the CD-ROM drive, and the signal for Panasonic jack is G-S-G-S and S-G-G-S for Sony.

### J3 – Sound and Game

Sound contains Line-in/MIC (Microphone), and Line-out (Speaker). Game connector is also the Joystic connector. Connect this connector to the Sound & Game ribbon cable/bracket as the following drawing:

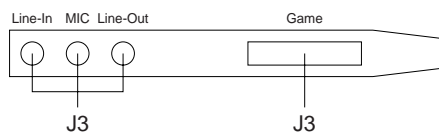

### J2 – Digital Audio IN

Depending on the type of your CD-ROM drive to connect this connector to “DIGITAL AUDIO” on the CD-ROM drive by using the SPDIF/IN cable.

### J1 – Digital Audio OUT

By using the optional SPDIF/OUT cable/bracket, you can connect the digital audio devices such as external audio amplifier or minidisk.

## Jumper Settings

### JP5 – DIMM Voltage Selectors

Voltage	Setting
5V	<div style="text-align: center;">A B</div>
3.3V (default)	<div style="text-align: center;">A B</div>

### JP2 – Microphone Type Selector



Description	Setting
Standard (default)	
Special	



### JP1 – Onboard Sound Pro Selector

Description	Setting
Enabled (default)	<div style="text-align: center;">1</div>
Disabled	<div style="text-align: center;">1</div>







**JP10 – CMOS RAM  
Clear Selector**

**JP7 – Frequency  
Selector**

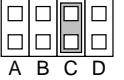
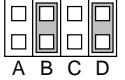
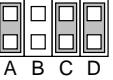
Description	Setting
Normal Mode	1 
Clear CMOS	1 

Frequency	Setting
66MHz	1 
100MHz	1 

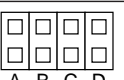
**JP3 (A, B, C, D) – Multiplier Selectors**

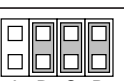
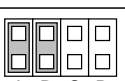
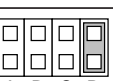
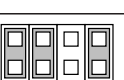
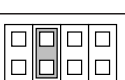
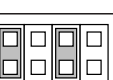
Mul.	Setting	Mul.	Setting	Mul.	Setting
1.5X		3.5X		6.0X	
2.0X		4.0X		6.5X	
2.0X		4.5X		7.0X	
2.5X		5.0X		7.5X	
3.0X		5.5X		8.0X	

## Memory Installation

The mainboard lets you add up to 384MB of system memory. Three 168-pin DIMM sockets are divided into three banks: Bank 0, Bank 1, and Bank 2. The mainboard supports the following memory configurations.

Bank	Memory Module
Bank 0 DIMM1	4MB, 8MB, 16MB, 32MB, 64MB, 128MB
Bank 1 DIMM2	4MB, 8MB, 16MB, 32MB, 64MB, 128MB
Bank 2 DIMM3	4MB, 8MB, 16MB, 32MB, 64MB, 128MB
Total System Memory = Bank 0 + Bank 1 + Bank 2	

*Notes: 1. The speed of SDRAM DIMM modules have to be faster than 12ns ("–12" parts), while 100MHz clock speed used, the speed of SDRAM DIMM should meet the PC100 SDRAM specification (8ns or "–8" SDRAM at least).*

*2. The EDO/FPM DRAM are not recommended for the performance purpose of the system.*

---

# Chapter 3

## ACPI Functions & Connectors with ATX Power

---

### PWR2 – ATX Style Power Connector

The ATX power supply provides a single 20-pin connector.

Pin	Description	Pin	Description
1	3.3V	11	3.3V
2	3.3V	12	-12V
3	Ground	13	Ground
4	+5V	14	PS-ON
5	Ground	15	Ground
6	+5V	16	Ground
7	Ground	17	Ground
8	Power OK	18	-5V
9	5VSB	19	+5V
10	+12V	20	+5V

The functions and connectors described below work with the ATX power supply.

### Software Power-Off

Follow the steps below to use the “Software Power-Off Control” function in Windows 95/NT with ATX power supply.

1. Click the **START** button on the Windows 95 task bar.
2. Select **Shut Down The Computer** to turn off the computer. The message “**It is now safe to turn off your computer.**” will not be shown when using this function.

### Modem Ring Power-On

While in Soft-off/Suspend state, if an external modem ring-up signal occurs, the system wakes up and can be remotely accessed. Make sure that the Ring Resume From Soft Off option is set to Enabled in the BIOS setup section (Refer to the Power Management section in Chapter 4.)

### Alarm Wake Up

If you want to autoboot the system at a certain time, set the function of RTC Alarm time properly and the function of RTC Alarm Resume From Soft Off option in the BIOS Setup section will be set to Enabled.

## **J5 (21, 22) (SUS-SW) – ATX Power Button and Suspend Switch Connector**

Attach the ATX Power Button or Suspend Switch cable to this connector.

In the AT power system, this connector will act as a suspend switch; and in the ATX power system, this connector will be not only an ATX power button but a Suspend switch as well. Details are described below:

When the system is off, push the power button to turn the system on. When the system is on, push the power button rapidly to switch the system to the Suspend mode, and, by pushing and holding the button for more than 4 seconds, it will turn the system completely off. When the system is in the Suspend mode, push the power button rapidly to turn the system on.



---

## Chapter 4

### BIOS Setup

---

This chapter explains how to configure the mainboard's BIOS setup program. The setup program provided with the mainboard is the BIOS from AMI.

After you have configured the mainboard and have assembled the components, turn on the computer and run the software setup to ensure that the system information is correct.

The software setup of the system board is achieved through Basic Input-Output System (BIOS) programming. You use the BIOS setup program to tell the operating system what type of devices are connected to your system board.

The system setup is also called CMOS setup. Normally, you need to run system setup if either the hardware is not identical with information contained in the CMOS RAM, or if the CMOS RAM has lost power.

*Note: Hold down the <End> key then power on to reboot the system when installing newer BIOS into this mainboard .*

## Entering BIOS Setup

To enter the BIOS Setup program:

1. Turn on or reboot the system. A screen appears with a series of diagnostic checks.
2. When “Hit <DEL> if you want to run SETUP” appears, press the <DEL> key to enter the BIOS setup program. The following screen appears:

AMIBIOS SIMPLE SETUP UTILITY - VERSION 1.1X  
(C)1998 American megatrends, Inc. All Rights Reserved

Standard CMOS Setup	Peripheral Setup
Advanced CMOS Setup	Change Supervisor Password
Advanced Chipset Setup	Auto-Detect Hard Disks
Power Management Setup	Save Settings and Exit
PCI/Plug and Play Setup	Exit Without Saving
Load Optimal Settings	
Load Best Performance Settings	
Esc: Quit    ↑ ↓ → ←: Select Item    (Shift) F2: Change Color    F5: Old Values F6: Optimal values    F7: Best performance values    F10 : Save&Exit	
Standard CMOS setup for changing time, date, hard disk type, etc.	

3. Use your keyboard to choose options. Modify system parameters to reflect system options. Press Alt-H for Help.

---

## Default

---

Every option in the BIOS Setup contains two default values: Best default and the Optimal default value.

### Load Optimal Settings

The Optimal default values provide optimum system settings for all devices and system features.

### Load Best Performance Settings

The Best default values provide best performance settings for all devices and system features, but it depends on the devices used and we aren't guarantee the length time used of system on these settings.

---

## Setup Items

---

### Standard CMOS Setup

Choosing the item from the BIOS Setup main menu. All Standard Setup options are described in this section.

**Date/Time**      Select the Date/Time option to change the date or time. The current date and time are displayed. Enter new values through the displayed window.

<b>Pri Master; Pri Slave; Sec Master; Sec Slave</b>	Choose these icons to configure the hard disk drive named in the option. When you click on an icon, the following parameters are listed: Type, LBA/Large Mode, Block Mode, 32Bit Mode, and PIO Mode. All parameters relate to IDE drives except <b>Type</b> . Choose the <b>Type</b> parameter and select Auto BIOS automatically detects the IDE drive parameters and displays them. Choose on <b>LBA Mode</b> and choose <i>On</i> to enable support for IDE drives with capacities greater than 528MB. Click on <b>Blk Mode</b> and choose <i>On</i> to support IDE drives that use Blk Mode. Click on <b>32Bit Mode</b> and click on <i>On</i> to support IDE drives that permit 32-bit accesses.
<b>Floppy Drive A; B</b>	Choose the Floppy Drive A or B icon to specify the floppy drive type. The settings are 360KB 5 <sup>1</sup> / <sub>4</sub> ", 1.2MB 5 <sup>1</sup> / <sub>4</sub> ", 720KB 3 <sup>1</sup> / <sub>2</sub> ", 1.44MB 3 <sup>1</sup> / <sub>2</sub> ", or 2.88MB 3 <sup>1</sup> / <sub>2</sub> ".

## Advanced CMOS Setup

Choosing the item from the BIOS Setup main menu. All Advanced Setup options are described in this section.

<b>Quick Boot</b>	Set this option to <i>Enabled</i> to permit BIOS to boot within 5 seconds.
<b>1st Boot Device; 2nd Boot Device; 3rd Boot Device</b>	Set these options to select the boot sequence from different booting devices.

---

<b>Try Other Boot Devices</b>	Choose <i>Yes</i> or <i>No</i> to search other boot devices to boot up the system when all the options in the previous function failed.
<b>Floppy Access Control</b>	This option is set to select the floppy access control.
<b>Hard Disk Access Control</b>	This option is set to select the hard disk access control.
<b>S.M.A.R.T for Hard Disks</b>	Choose <i>Enabled</i> or <i>Disabled</i> . This option allows you to utilize the S.M.A.R.T. function of HDDs.
<b>Bootup Num-Lock</b>	When this option is set to <i>On</i> , BIOS turns off the Num Lock key when the system is powered on so that arrow keys on both numeric keypad can be used.
<b>Floppy Drive Swap</b>	This option allows you to swap floppy drives between A: and B:.
<b>Floppy Drive Seek</b>	Choose <i>Enabled</i> or <i>Disabled</i> . <i>Disabled</i> provides a faster boot and reduces the possibility of damaging the heads.
<b>PS/2 Mouse Support</b>	When this option is set to <i>Enabled</i> , BIOS supports a PS/2-type mouse.
<b>Primary Display</b>	This option specifies the primary display in the computer.

<b>Password Check</b>	<p>This option specifies the type of BIOS password protection that is implemented. The settings are:</p> <p>Setup: The password prompt appears only when an end user attempts to run WinBIOS Setup.</p> <p>Always: A password prompt appears every time the computer is powered on or rebooted.</p> <p>The BIOS password does not have to be enabled. The end user sets the password by choosing the Password icon on the WinBIOS Setup screen.</p>
<b>Boot to OS/2 Over 64MB</b>	<p>You need to set this option to Enabled when using the OS/2 operating system with installed DRAM which is greater than 64MB.</p>
<b>Internal Cache</b>	<p>This option selects to enable the internal cache or not. Choices are Disabled and Enabled.</p>
<b>Cache Bus ECC</b>	<p>This option allows you to enable ECC checking in internal cache bus.</p>
<b>System BIOS Cacheable</b>	<p>BIOS always copies the system BIOS from ROM to RAM for faster execution. Set this option to <i>Enabled</i> to permit the contents of the F0000h RAM memory segment to be written to and read from cache memory.</p>

<b>C000, 32K Shadow; C800, 16K Shadow; CC00, 16K Shadow; D000, 16K Shadow; D400, 16K Shadow; D800, 16K Shadow; DC00, 16K Shadow</b>	Disabled:	The specified ROM is not copied to RAM.
	Enabled:	The contents of the ROM area are not only copied from ROM to RAM for faster execution, the contents of the RAM area can be written to or read from cache memory.
	Cached:	The contents of the ROM area are copied from ROM to RAM for faster execution.

### Advanced Chipset Setup

Choose the item from the BIOS Setup main menu. All Chipset Setup options are then displayed and are described in the following section:

<b>Bank1, 2, 3 SDRAM/EDO/FPM</b>	Set these options to select the speed of used memory bank.
<b>SDRAM CAS Latency</b>	This option is designed to select the SDRAM CAS Latency.
<b>RAS to CAS Delay</b>	This option is to select delay time of RAS to CAS.

<b>DRAM Integrity Mode</b>	Choose Non-ECC, EC-Only, or ECC. Non-ECC: Has byte-wise write capability but no provision for protecting data integrity in the DRAM array. EC-Only: Data errors are detected but not corrected. ECC: Allows a detection between single-bit and multiple-bit errors and recovery of single-bit errors.
<b>A.G.P. Aperture Size</b>	Choose 4MB, 8MB, 16MB, 32MB, 64MB, 128MB, or 256MB. Memory-mapped, graphics data structures can reside in the Graphics Aperture. Use the default setting.
<b>USWC Memory Gap Size</b>	Choose Auto, 1MB, 2MB, 4MB, 8MB, or 16MB for USWC memory gap size. Use the default setting.
<b>AT Bus Clock</b>	This option is to select the clock of AT Bus.
<b>ISA Line Buffer</b>	This option is to enable ISA Line Buffer.
<b>Delay Transaction</b>	This option is to enable Delay Transaction.
<b>OnBoard USB Function</b>	Choose Enabled or Disabled. Set this option to enable the system BIOS USB (Universal serial Bus) functions.
<b>USB Function for DOS</b>	Choose Enabled or Disabled. Set this option to enable the passive release on the USB (Universal Serial Bus).



## Power Management Setup

Choosing the item from BIOS Setup main menu.

<b>Power Management/ APM</b>	Set this option to enable power management features and APM (Advanced Power Management).
<b>Green Monitor Power State</b>	This option specifies the power state that the green PC-compliant video monitor enters when AMIBIOS places it in a power savings state after the specified period of display inactivity has expired.
<b>Video Power Down Mode</b>	This option specifies the power conserving state that the VESA VGA video subsystem enters after the specified period of display inactivity has expired.
<b>Hard Disk Power Down Mode</b>	This option specifies the power conserving state that the hard disk drive enters after the specified period of hard drive inactivity has expired.
<b>Standby Time out (Minute)</b>	This option specified the length of system inactivity while in Full power on state. When this length of time expires, the computer enters Standby power state.
<b>Suspend Time out (Minute)</b>	This option specified the length of a period of system inactivity while in Standby state. When this length of time expires, the computer enters Suspend power state.
<b>Modem Use IRQ</b>	This option is to specify IRQ for modem device.

**\* System Event Monitor By \***

<b>Monitor Parallel Port;</b>	When set to <i>Yes</i> , these options enable event monitoring on the specified hardware interrupt request line and the computer is in a power saving state, BIOS watches for activity on the specified IRQ line. The computer enters the full on power state if any activity occurs.
<b>Monitor Serial Port;</b>	
<b>Monitor Floppy;</b>	
<b>Monitor VGA;</b>	
<b>Monitor Audio;</b>	
<b>Monitor Pri-HDD; Monitor Sec-HDD</b>	
<b>Power Button Function</b>	Set this option to specify the operation of Soft Off by the power button. Select "Suspend" function to enter On-Suspend-Off or select "Soft Off" function to enter On-Off operation cycle.
<b>Restore On AC/Power Loss</b>	Set this option to specify the operation of restore power loss.
<b>Ring Resume From Soft Off</b>	Set this option to enable the modem ring to resume from Soft Off.
<b>RTC Alarm Resume Soft Off</b>	Set this option to enable the RTC Alarm to wake up the system which is Soft Off.
<b>RTC Alarm Date; RTC Alarm Hour; RTC Alarm Minute; RTC Alarm Second</b>	Set these options to specify the RTC Alarm time on Date/Hour/Minute/Second.

## PCI/Plug and Play Setup

Choose the item from the BIOS Setup main menu.

- Plug and Play Aware OS** Set this option to *Yes* if the operation system in this computer is aware of and follows the Plug and Play specification. Currently, only Windows 95 is PnP-aware.
- PCI VGA Palette Snoop** When this option is set to *Enabled*, multiple VGA devices operating on different buses can handle data from the CPU on each set of palette registers on every video device. Bit 5 of the command register in the PCI device configuration space is the VGA Palette Snoop bit (0 is disabled).
- Assign IRQ to PCI VGA** This option is used to allocate IRQ to PCI VGA. Recommendation is set to *No*.
- OffBoard PCI IDE Card** This option specifies if an offboard PCI IDE controller adapter card is installed in the computer. You must specify the PCI expansion slot on the motherboard where the offboard PCI IDE controller is installed. If an offboard PCI IDE controller is used, the onboard IDE controller is automatically disabled. If an offboard PCI IDE controller adapter card is installed in the computer, you must also set the **Offboard PCI IDE Primary IRQ** and **Offboard PCI IDE Secondary IRQ** options.
- Pri. OffBoard PCI IDE IRQ;** These options specify the PCI interrupt used by the Primary (or secondary) IDE channel on the offboard PCI IDE controller.
- Sec. OffBoard PCI IDE IRQ**

**PCI Slot1, 2, 3 IRQ Priority** Set these options to specify IRQ Priority to PCI slots.

**DMA Channel 0, 1, 3, 5, 6, 7** These options specify the bus that the specified DMA channel is used on.

**IRQ3, 4, 5, 7, 9, 10, 11, 14, 15** These options specify the bus that the specified IRQ line is used on. These options allow you to reserve IRQs for legacy ISA adapter cards.

## Peripheral Setup

Choose the item from the BIOS Setup main menu.

**OnBoard FDC** This option enables the FDC (Floppy Drive Controller) on the motherboard or auto detects the FDC.

**OnBoard Serial Port1** This option specifies the base I/O port address of serial port 1.

**Serial Port1 Mode** This option specifies the serial port1 mode.  
Normal: The normal serial port mode is being used.  
IrDA/ASKIR: The serial port1 will be redirected to support IR function when this option is set to IrDA or ASKIR.

**IR Duplex Mode; IR Trans. Polarity; IR Receiver Polarity** Set these options to configure the IR particularity when either IrDA or ASKIR is chosen in the previous option.

- OnBoard Serial Port2** This option specifies the base I/O port address of serial port 2.
- Serial Port2 Mode** This option specifies the serial port2 mode.  
Normal: The normal serial port mode is being used.  
IrDA/ASKIR: The serial port2 will be redirected to support IR function when this option is set to IrDA or ASKIR.
- IR Duplex Mode;** Set these options to configure the IR  
**IR Trans. Polarity;** particularity when either IrDA or ASKIR is  
**IR Receiver Polarity** chosen in the previous option.
- OnBoard Parallel Port** This option specifies the base I/O port address of the parallel port on the motherboard.
- Parallel Port Mode** Depends on the type of your external device which connects to this port to choose Normal, EPP, or ECP mode.
- EPP Version** Set this option to select version of EPP.
- Parallel Port IRQ** This option specifies IRQ to parallel port.
- Parallel Port DMA Channel** This option is only available if the setting of the Parallel Port Mode option is EPP/ECP.
- OnBoard IDE** This option specifies the channel used by the IDE controller on the motherboard.

## Change Supervisor Password

This item lets you configure the system password which is required every time when the system boots up or an attempt is made to enter the Setup program. The password cannot be longer than six characters.

*Note: Keep a safe record of the new password. If you forget or lose the password, the only way to access the system is to clear CMOS memory by holding down the <End> key then powering on to reboot the system.*

## Auto-Detect Hard Disks

If your system has an IDE hard drive, you can use this utility to detect its parameters and automatically enter them into the Standard CMOS Setup. This utility will autodetect up to four IDE devices.

## Save Settings and Exit

Select this item to save the values entered during the current session and then exit the BIOS setup program.

## Exit Without Saving

Select this item to exit the BIOS setup program without saving the values which has been entered during the current session.