

TANDY LAPTOP COMPUTING

MAY 1992 -VOL. 9, NO. 5

TERRY KEPNER'S

portable 100

A MONTHLY PUBLICATION (EXCEPT COMBINED JULY/AUGUST ISSUE)

\$3.99/CAN \$4.95

Keep Your Computer Healthy

- ✓ Software protection
- ✓ Carrying it safely
- ✓ Saving data from prying eyes.
- ✓ Dealing with repair services

Add a Hard Drive

NiCd Power for Your Portable

Batteries: How Good?





More Than Just a Laptop User Group

Supporting Tandy/Radio Shack Model 100, 102, 200 and WP-2 Computer Owners Since 1983

Lapdos II

Turn your Model 100/102/200/NEC8201 into a PC-partner. Connect your laptop computer or Tandy Portable Disk Drive directly to MS-DOS computers for file transfers at 19200 baud. Fast! Easy to use. Single or batch file transfers at the press of a button. Feature rich!

WP2DOS Plus

Turn your WP2 into a PC-partner. The only "file transfer" and "file conversion" software available on WP2 to DOS computer owners. Online utilities convert WP2 .DO files to popular DOS word processing file formats ... maintains file formatting codes. Super easy and fast.

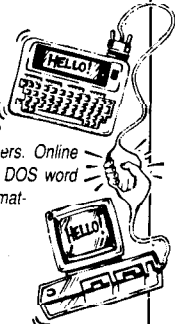

WPduet

Turn your WP2 into a Mac-partner. Connect your laptop computer or Tandy Portable Disk Drive directly to Macintosh computers for file transfers at 19200 baud. Fast! Easy to use. Single or batch file transfers at the press of a button. Automatic file translations allow your Mac programs to use your laptop files, directly! Maintains file formatting codes.

100duet

Turn your Model 100/102 into a Mac-partner. Connect your laptop computer or Tandy Portable Disk Drive directly to Macintosh computer for file transfers at 19200 baud. Fast! Easy to use. Single or batch file transfers at the press of a button. Automatic file translations allow your Mac programs to use your laptop files, directly!

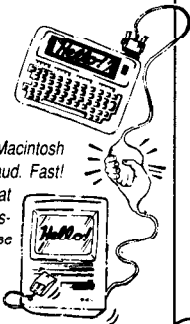

Power Pillow

Good-looking, powerful, long-lasting battery pack encased within an attractive black-vinyl holder provides hundreds of hours of battery life. Attaches to the back/bottom of your laptop with velcro (included). Hand crafted and tested. (Requires 4, "D" cell batteries, not included).

The Ultimate ROM II

Four programs in one make this more than just a "super" ROM.

T-WORD: overwrite/insert mode while editing, imbed print controls, control print output (margins, line spacing, page feeds, headers, footers, auto page numbering, bold face, underline, italics, mail merge, labels, and more), pixel-plot view of document before printing. **T-BASE:** true relational basic operations, key field sorts, math, report generation, etc. **IDEA!** outliner program for concept development. **VIEW 80:** see up to 60 characters per line while in TEXT, TELCOM and BASIC, fast processing, easy to read. **TS-DOS & SARDINE LINK:** automatically loads and runs TS-DOS and SARDINE from disk. (TS-DOS and SARDINE sold separately).



TS-DOS (ROM or Disk)

Super fast, easy access to your TPDD or TPDD2. Available for Models 100/102/200 and NEC8201. Features: file tagging, file printing direct from disk or RAM, direct access to disk drive from within BASIC or TEXT. Disk version works with the Ultimate ROM II or independently.

SARDINE (ROM or Disk)

Spell check your words. Fast. 33,000 word electronic spell check and dictionary. Corrections automatically inserted into text. ROM version includes T-word. Disk version works with the Ultimate ROM II or independently.

ROM2/Cleuseau

The very best programming tools available for Model 100/102/200 and NEC8201 laptop programmers. Two ROMs in one, and more. ROM2 is a full functioned 8085 macro assembler. Cleuseau adds much needed features to BASIC and TEXT. Call for full details.



Hard Cover

Protect the top of your 100/102/NEC8201 with a made-to-fit hard, black plastic cover. Looks good. Works great. WP2 protection cover available, too.

Keyboard Bands

Just the right size dental rubber bands necessary to almost eliminate Model 100/102/200 keyboard noise. Great for library and meeting use. Easy to install. Instructions included.

RAM, RAMPAC Storage, Multi-ROM/ROM

We have the widest selection of expansion RAM's, RAMPAC storage, and a device that can be used as extra RAM or as a multi-ROM bank. Exciting solutions!

Free BBS

Our free-2-use bulletin board computer is available 24 hours a day. Features: free public conference, free classified advertising, free laptop reference material, free newsletter, free downloads, product ordering, assistance, and more. Log on with any computer. Simple menus fit all 40 character, 8 line displays. Fast, interrupt drive, easy to use for beginners. Friendly. No online cost. Unlimited online time. PC Pursuitable! Optional online library access \$1 a month.



Program Collections

We have the largest "quality" collection of public domain, shareware and author-specific programs available for Model 100/102/200 users, i.e., text, print, telcom, business, graphics, drives, utilities, games, music, programming, education. Available online or mail order on disk. Listings available.

"Look to Club 100 for the largest selection of performance products to make you a laptop power user. Call today!"

Rick Hanson
Rick Hanson, Club 100

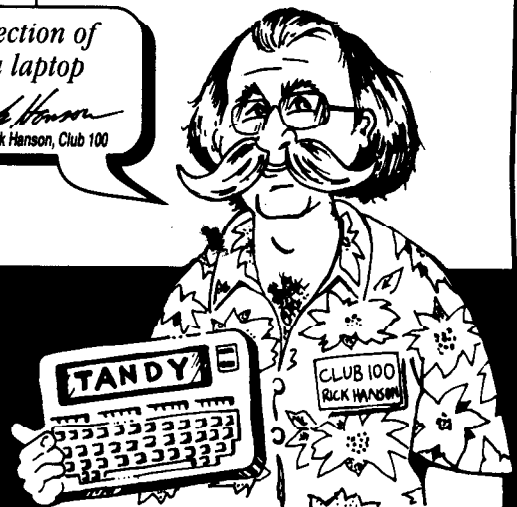

We're Always Adding Nifty New Stuff!
Call Today For Our FREE 1992 Catalog

(510)932-8856 voice • 937-5039 fax • 939-1246 bbs

CLUB 100 PO Box 23438, Pleasant Hill, CA 94523, 0438

Amherst has Three Ideal Solutions for Your Portable Computing Needs

The Ultimate Case- only \$109.95



- the ideal attache and computer case in one— with storage for folders, pens, pencils, cards and all business essentials
- unique hidden pocket carries accessories, printers, and even cellular phones, yet zips away when not needed
- exclusive shielded diskette pockets protect your valuable data
- moveable divider allows you to configure the case your way
- leather palm grips for ultimate comfort
- high density Volara® closed cell foam padding ensures long term durability and protection

- this handsome case has the look and feel of real leather
- careful design includes disk pockets, business card holder, pen & pencil storage as well as your notebook computer
- security strap for safe carrying
- interior pocket for writing pads and folders
- ideal lightweight size fits right into your briefcase

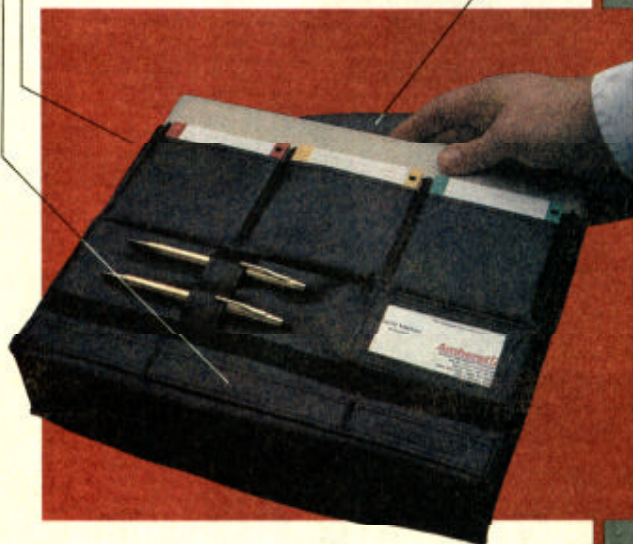

The Notebook Slipcase- only \$39.95

The Executive Case- Only \$84.95



- designed like our Ultimate case but with a permanent exterior pocket and non-shielded diskette storage
- same excellent construction of Cordura® nylon— but with standard padding
- same well-organized storage space for diskettes, pens, business cards, folders, and computer
- same removeable shoulder strap for easy carrying
- same versatile sizes— for all laptops and notebooks

For your most convenient source of these and other computer solutions, call Amherst at 1-800-547-5600. All these Amherst products have a lifetime guarantee, and are backed by 17 years of expertise.

Amherst
The Experts in Computer Care and Protection™

Amherst International Corporation
540 No. Commercial Street
Manchester, NH 03101

Tel. (603) 644-3555 Tel. (800) 547-5600

Fax: (603) 644-3550

ON
THE
COVER:

We wish to thank Ray-O-Vac for letting us use this beautiful photograph of their promotional balloon shaped like one of their batteries. Wish we were floating above that scenery right now ourselves!

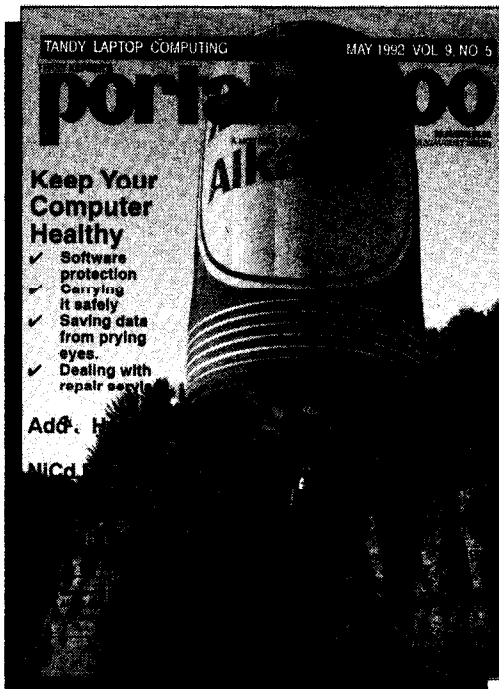

10 LEISURE COMMUNICATIONS
 ✓ MS-DOS
 ✓ M-102
 ✓ WP-2
 by Chris Courson
Understanding and accessing the Portable 100 BBS.

11 XSEND.COM — XMODEM SEND PROGRAM
 ✓ MS-DOS
 M-102
 WP-2
 by John Comeau
One-way file transfer — quick and dirty.

14 THE ULTIMATE SHIPPING AND CARRYING CASE
 ✓ MS-DOS
 ✓ M-102
 ✓ WP-2
 by Beau Keller
Are you looking for a shipping case strong enough to protect your computer from anything.

16 KEEP YOUR SOFTWARE SAFE
 ✓ MS-DOS
 M-102
 WP-2
 by Terry Kepner
Don't let a computer virus destroy your business.

20 LETTING THE SHACK SHIP IT
 ✓ MS-DOS
 ✓ M-102
 ✓ WP-2
 by Ed Dahlgren
If your computer needs repairs, here's how to make sure they are done properly.

23 PRYING EYES
 ✓ MS-DOS
 M-102
 WP-2
 by Terry Kepner
You can lose data without losing your computer, either in theft or to a virus.

25 RADIO SHACK BATTERIES OUTLAST THE REST
 ✓ MS-DOS
 M-102
 WP-2
 From PCLINK
To those who know, it's no surprise.

26 TANDY 102 PORTABILITY LIVES!
 ✓ MS-DOS
 M-102
 WP-2
 by Karl M.Lind
These sometimes undocumented methods can save you when you use electronic mail.

28 NOT A SCUZZY HARD DRIVE
 ✓ MS-DOS
 M-102
 WP-2
 by Ches Looney
Add an external hard drive to your computer.

30 DVORAK: A BETTER KEYBOARD
 ✓ MS-DOS
 M-102
 WP-2
 by Mike Nugent
Changing to a faster keyboard.

36 FIREBALL.100
 ✓ MS-DOS
 M-102
 WP-2
 by Thomas H. Jones, Jr.
A fast-paced game for the Tandy Model T family.

37 TIPS AND HINTS
 ✓ MS-DOS
 ✓ M-102
 ✓ WP-2
 by various
Weetax users and Deskmate users will like this.

38 WP-2 ARCHITECTURE
 ✓ MS-DOS
 M-102
 ✓ WP-2
 by Stan Wong
Mandatory bussing (and you thought it was only students).

DEPARTMENTS

ROM WITH A VIEW	Protecting your investment in time and equipment.	4
I/O	What to do, and how to do it.	8
DEFUSR	Answers to questions.	33
NEW PRODUCTS	New cases, printers, and software.	34
PORTABLE 100 CLASSIFIEDS	Software, hardware, wanted.	43
ADVERTISERS' INDEX		44

BACKUP ALL OF YOUR PC COMPATIBLES WITH ONE PORTABLE TAPE SYSTEM



- **160 Megabyte Capacity**
- **Backup At Over 6 Megabytes A Minute**
- **Save Backup Time Management Time and *Drastically Decrease Media Costs***
- **Easy to Use "Windows-Based" Menu-Driven Interface Software**
- **Small, Portable and Lightweight**
- **NO MORE LOST DATA OR FLOPPY DISKS TO MANAGE**
- **NO ADD-IN CARDS NEEDED "Plug and Go" over the Parallel Printer Port**
- **30 Day Money Back Guarantee**



ONE FOR ALL™ MODEL #PT1

Contact ADPI For
More Information
Analog & Digital
Peripherals Inc.
PO Box 499
Troy, Ohio, 45373
513/339-2241
Fax: 513/339-0070

ROM WITH A VIEW

March's media onslaught about the Michaelangelo virus provided the basis for this issue: protection.

To help you keep your portable in trim, we decided to run a group of articles on protecting your investment in your computer. The MS-DOS users will appreciate our review of two virus-fighting packages and the software hard disk lock. The first two keep your files safe from malicious marauders, and the other keeps your important data safe from prying eyes (losing your computer is bad enough, but sometimes having your important files available to someone else can be catastrophic to your company and personal finances).

The Model T folks have a couple of articles on batteries and adding Nickel-Cadmium capability. Not surprisingly, Tandy batteries score quite high. A recent issue of *Consumer Reports* gave Tandy NiCd's top marks in life and low cost.

Both types of users will find the article on the hard-shell carrying case a useful lead.

On a different note, Mike Nugent is pulling back a bit on his involvement with the magazine. He'll still be providing us with articles and technical assistance, but will no longer be handling day-to-day problems. On the plus side, this means more articles with his byline will appear.

This is our second issue going into New York City newsstands. With a bit of luck we'll see the same response we had the last time we were on newsstand, about a 70% sell-through factor (that means that for every ten issues we put on newsstand, seven are actually purchased). If this test market ploy works, we'll go nationwide in a few more months and our circulation will climb to well over fifty thousand. That many additional readers means we can get in some of the heavy advertisers and increase the size of the magazine. And that means more articles about both the MS-DOS and the Tandy Model T computers.

Unfortunately, newsstand sales are a break-even proposition at best, so even if we are selling forty thousand copies a month, the money will barely cover the cost of printing and shipping. We have our fingers crossed.

You may have noticed that our cover is of the Ray-O-Vac balloon. We would have loved to use a Tandy photo instead, but they don't have a balloon (or any other exciting photographs).

If you see something that might make a good cover photograph for us, tell us about it. In fact, if you have a photograph of a Tandy computer in use in the field (or warehouse or airplane or wherever), please send us a copy. We might be able to use it. We can't promise to pay you for it, but it is an easy way to break into the cover market and build a reputation. Besides, look at all the bragging you can do.

If you want to try your hand at cover photography, the only requirements are clear vertical pictures with the top third and left quarter of the picture uncluttered (that leaves us room for the *Portable 100* logo and room down the left side for article teasers). It's not hard to do and many of the covers over the last few years have come from amateurs who shipped us their attempts. We can use slides, but prefer glossy color photos.

We're still looking for articles on both the MS-DOS and Model T portables. We especially need articles with *BASIC* programs that work in both Model T *BASIC* and MS-DOS *BASIC*.

Those *BASIC* ones really aren't that difficult; The only real differences between them is that MS-DOS *BASIC* requires spaces between keywords and uses the *LOCATE* command instead of *PRINT@*. (There are other differences, but the ones I mention are the major ones).

In the meantime, keep those letters coming in, especially the hints and tips that you discover by accident.

Terry Kepner

Toolbox

Manuscripts were typed into Microsoft Word 4.0 on a Tandy 1500 HD, where they were edited, spell-checked, and had basic format instructions inserted. From there they were loaded into a Tandy 4000 (80386 CPU, Tandy EGA Monitor, Tandy LP-1000 LaserPrinter) desktop computer and placed into Aldus' IBM PageMaker 3.01. Once there, design decisions on photo, figure, and listing sizes and placement were made. Here, pull quotes are placed, headlines, intros, and bylines are sized and positioned, and advertisements positioned.

Normally, the Tandy LP-1000 is capable of emulating only a Hewlett Packard Laser Printer Plus, but with the

addition of the Destiny Technology Corporation (300 Montague Expressway, Suite 150, Milpitas, CA 95035. (408) 262-9400) PageStyler 4.5MB kit, the LP-1000 is turned into a fully-compatible PostScript printer, with all 35 native fonts that are found in the Apple LaserWriter Plus printer. The Destiny PageStyler is available through the Tandy Express Order Hardware system.

Page previews were output from the LaserPrinter. When everyone was satisfied with the appearance, final pages were output and artwork and line art ads were positioned. The finished magazine was then delivered to the printer, who printed it, labeled it, and mailed it to you.

portable 100

PRESIDENT/PUBLISHER
Terry Kepner

TECHNICAL EDITOR
Mike Nugent

EDITORS
Terry Kepner, Mary Fraser
David Klein, David Sprague

NEW PRODUCTS EDITOR
Linda Tiernan

CONTRIBUTING EDITORS
Barbara Schwartz, Paul Globman
Michael Daigle, George Sherman
Stan Wong, Tony Anderson
Gene Wilburn

CIRCULATION
Bob Liddil

ADVERTISING DIRECTOR
Bob Liddil

ADVERTISING ASSISTANT
Pauline Halvonik

BULLETIN BOARD SYSOP
Chris Courson

**Portable Computing
International Corporation**
145 Grove St. Ext., #21, PO Box 428
Peterborough, NH 03458-0428
Tel: 603-924-9455 Fax: 603-924-9441



The Portable 100 Bulletin Board
603-924-9770
(300/1200/2400—8.None.1)

Portable 100 (ISSN 0888-0131) is published by Portable Computing International Corporation, 145 Grove Street Ext., P.O. Box 428, Peterborough, NH 03458-0428. *Portable 100* is an independent journal not connected with any hardware, software, or peripheral equipment manufacturer. *Portable 100* is published monthly, except for a combined July/August issue in the summer. Entire contents Copyright © 1992 by Portable Computing International Corporation, All Rights Reserved. No part of this publication may be reproduced without written permission from the publisher. Portable Computing International Corporation makes every effort to assure the accuracy of articles published in *Portable 100*, but assumes no responsibility for damages due to errors or omissions. Subscription Service: All subscription correspondence should be addressed to *Portable 100*, Portable Computing International Corporation, 145 Grove Street Ext. P.O. Box 428, Peterborough, NH 03458-0428. U.S. subscription rates: \$19.95, one year; \$34.95 two years. Canada and Mexico: US\$24.95, one year; US\$44.95 two years. All other foreign (surface mail): US\$39.95, one year; US\$74.95 two years. Foreign Air Mail, add US\$50 per subscription year. All payment, except Canada, U.S. funds drawn on U.S. Bank. Second-class postage paid at Peterborough, NH 03458, and at additional mailing offices.

POSTMASTER: Send address changes to: Portable 100, Portable Computing International Corporation, 145 Grove Street Ext., PO Box 428, Peterborough, NH 03458-0428.

SUPER ROM

Lucid Spreadsheet

Write ROM

Database

Outliner

Boots
the Tandy
Portable Drive
with one
button!



Now
Available
for the
Model
200!

NOW YOU CAN REALLY HAVE IT ALL!

All on one ROM. Truly the finest four programs available for the Model 100 — guaranteed. Try it for 30 days. If you aren't blown away by the excellence return it for a full refund.

\$199⁹⁵

(Please add \$5.00 shipping & handling)

The four best programs for the Model 100 all on one ROM. 32K of power without using any RAM for program storage. This is the PCSG Snap-In ROM that just presses easily into the little ROM socket in the compartment on the back. You access the four right from the main menu like built-ins.

Write ROM — the definitive word processor for the Model 100. Function key formatting or dot commands. Search and replace. Library feature — inserts words, phrases or whole documents into text from just a code. MAP lets you see a picture of your document. In all there are 60 features and functions. No one can claim faster operation. FORM lets you create interactive forms with on-screen prompts that you can answer from the keyboard. Nothing else for the Model 100 compares with the features of Write ROM. Exactly the same as the Write ROM sold as a single program. Infoworld says it "makes the Model 100 a viable writing unit ... sur-

passed our highest expectations for quality and clarity."

Lucid Spreadsheet: This is the one PICO magazine says "blows Multiplan right out of the socket" and Infoworld performance rated as "excellent" and said "makes the Model 100 compute." Gives you features you cannot get with Lotus 123. Lets you build spreadsheets in your Model 100 that would consume 140 150K on a desktop. Program generating capability with no programming knowledge required. Variable column widths. Includes find and sort with function key control. It's fast, recalculates like lightning. No feature has been taken from the original, only new ones added.

Database: This is a relational data base like no other. You can do everything from mailing lists to invoices. No complicated pseudo-coding, you create input screens as simply as typing into TEXT. You are not limited by size; you can have as large an input screen as you wish. Prints out reports or forms, getting information from as many files as

you like. Complete math between fields. Total interface with Lucid worksheets.

Outliner: Does everything that Think-tank does on a PC but a whole lot better. Includes a Sort for your headlines. Lets you have headlines of up to 240 characters. Has cloning, hoisting and sideways scroll up to 250 characters. Like Lucid, this one sets a new standard for outliners. This is the way to plan and organize your projects.

Present Lucid and Write ROM owners can upgrade for \$150. If you have both it's \$125.

As usual PCSG sells the Super ROM on a thirty day guarantee. If for any reason you are not satisfied, simply return it for a full refund.

We are excited about this product. Super ROM gives the Model 100 the true power of a desktop. No other multi-program ROM has software that compares. But don't take our word for it. We invite you to make that comparison yourself. Priced at \$199.95 on Snap-In ROM.

*Another fine product
from the innovative people at PCSG!*

*Got stuck with somebody else's multi-ROM?
We'll upgrade it for \$150.*

Distributed by:

Tri-Mike Network East

P.O. Box 372, Peterborough, NH 03458 • 1(603)924-8663

© PCSG

MC, Visa, American Express, Check, or C.O.D.

Circle 72 on reader service card.

Job Search

With the recession causing businesses to trim down, I've started my search for a job. I've been able to organize and consolidate my efforts with my trusty Model 100. I've added a multi-bank expansion board, *Ultimate ROM II*, *TS-DOS ROM*, Tandy PDD2, multiple outlet rechargeable power unit, and a portable printer. The complete kit fits in one oversized briefcase, along with my normal office supplies, manuals and paperwork.

My subscription to *Portable 100* magazine helps me stay up to date on what's new. I'm also a member of Club 100. Their BBS and member accessible library of programs has expanded my 100's versatility, also.

Without these tools, I would be carrying three brief cases full of files! Carrying around a number of huge ring-back binders full of references or job prospects can wear you down! A couple of pounds of Model 100 with multiple banks on board and I can out-juggle the best pencil-pusher, plus search for a specific item in one-tenth of the time!

Jack E. Marriott
Worcester, MA

WHATARYU.BAT CORRECTION

For those of you who subscribe to *Portable 100*, I typo'd the *WHATARYU.BAT* program. It should be errorlevel 253 for the pcjr, not 243.

Also, don't try typing in the *.DBG* listings. The spacing has to be exact, and it's not printed correctly. If it's not on the *Portable 100* BBS, or if you have no access to that, I'll see if the editors will post those files here or let me do so. Also, I can take no credit for the butchered grammar in the last sentence.

John Comeau

The spacing problem arose because of the typesetting equipment. Not being well versed in .DBG files, we did not realize there would be a problem until John contacted us to report the mistake. Sorry.

As for the butchered grammar problem, no one seems to want to admit to being the culprit. (Sorry, John).

-tk

TRS-80 AND GENEALOGICAL RESEARCH

I was a complete novice in December 1985 when my choice of a Christmas gift from my husband was a TRS-80, Model

100 and a dot matrix printer, DM-105.

A friend had a Model 100 at the NC State Archives and felt that if I had one it would save a lot of time, as I do genealogical research. When taking notes by hand, and having to type them at home on an old typewriter, there was always a question of what to include in the report to a client. With the Model 100, a copy was printed for the client, one for my file, and the file was killed, reusing the same memory. What a time saver it is.

However, the 24K memory proved to be very limited when abstracting records to be published in a journal. Since Radio Shack wanted about \$100 for 8K, several of us ordered from a company advertising in your magazine and purchased 8K for very little. I installed my chip and never had any problem with it.

With *Text*, it was impossible to

I installed my chip and never had any problem with it.

change margins, so ordered only *WRITE ROM*. It has only 60 functions, is easy to use and I just love it.

Our local genealogical society formed a computer group and began teaching us the basics on computers. Having learned the language, the next purchase was a PC compatible with 640K RAM, 30 mb harddrive, Multi I/O card, Hercules Graphics Card and DOS 3.3. Eventually I purchased a DWP-530 printer.

Through another ad in your magazine, I ordered *TRANSFER.COM*, which allowed me to gather data with the portable at the Archives and dump into the desktop, using RS232C and a null modem.

Since my Model 100 is used basically only for data gathering and client reports, your articles don't apply to me anymore.

It's a great magazine and I learned

much from it. There will be others who will need and purchase the magazine.

Harriette H. Riggs
Raleigh, NC

I must admit that I'm sorry to hear you no longer need our magazine. On the other hand, should you graduate to a portable MS-DOS Tandy computer, look us up.

-tk

MEETING OF THE MINDS

I am sending this note to you as the address for Mr. Charles M. Sprague was not complete enough to send it directly to him.

Mr. Sprague: A few of our Commodore club members also have Model 100 computers and have been moving files back and forth between them and either Commodore 64 or Commodore 128 computers. With this experience, I would like to offer a couple of suggestions for the system you covered in your letter to *PORTABLE 100* (March 1992).

Firstly, in using the *OMNITRONIX RS-232* interface on your 64, it is NOT necessary to use a null modem adapter (such as the Radio Shack unit you mention). If you set the interface to the *PRINTER* rather than the *MODEM* positions, the interface does the null modem function for you (that is basically what an *RS-232* serial printer wants to see anyway). I regularly use an *OMNITRONIX* interface in this mode.

Secondly, with an appropriate terminal emulator running in the 64 (such as *TERMINAL ONE*), you can transmit and/or receive files at 2400 baud rather than the 300 baud you have been using (You did not mention what terminal program you are using on your C-64). Thus, *TELCOM* can be set for 68N1E and it will talk nicely to your C-64.

Emil J. Volcheck, Jr.
President, MLCUG
West Chester, PA

Thanks for the help, Emil.

-tk

CONVERTING 100/102 PROGRAMS TO 200 USE

I find that even the published programs that I don't use can often provide insights to solving other programming problems. Still, I do have one frustration...

I have moved up to a Tandy 200. While most of the BASIC programs from

New Price
Reductions!

USED TANDY LAPTOPS!

TANDY 1400 HD 20 MEG	\$ 695.00
TANDY 1400 LT — 2 DR.	\$ 445.00
TANDY 1100 FD — 1 DR.	\$ 435.00
MODEL 100 — 32K	\$ 255.00
MODEL 102 — 32K	\$ 285.00
MODEL 200	\$ 345.00
NEC MULTISPEED - 2 DR	\$ 335.00
PORTABLE DISK DRIVE I 100K	\$ 95.00
PORTABLE DISK DRIVE II 200K	\$ 125.00
TANDY DMP 105 OR 106	\$ 65.00
TANDY TRP 100 THRM PORT. PTR.	\$ 65.00
DICONIX INK JET PORT. PTR.	\$ 165.00
BROTHER HR-5 THERMAL	\$ 65.00
TTX THERMAL PORTABLE	\$ 75.00
128K & 256K MEMORY FOR 102	\$ CALL
MEM, SOFT, MODEMS & BOOKS.	\$ CALL

We Buy & Sell MD 4's - 6000's
1000, 2000's, 3000's, & 4000's

503 236-2949

Pacific Computer Exchange
1031 S.E. Mill St. Suite # B,
Portland, OR 97214
THE **ONE SOURCE FOR USED**
TANDY EQUIPMENT

Circle 45 on reader service card.

PROTECT YOUR GOODIES!!

Announcing the all new **TurtleShell 2™** deluxe face cover for the WP-2! This amazingly tough plastic cover protects the vital parts of your WP-2 (the keyboard and the viewscreen) from impact, scratching, intrusive liquids and other hazards that might be encountered between typing assignments.

Cover-off, your WP-2 is ready for action. **Cover-on**, and your hard surfaced **TurtleShell 2™** is ready to take on the most hostile environment your WP-2 is capable of surviving!

ONLY \$14.95

\$2.00 S&H (Calif. Res. add 8.25%)



510-932-8856 voice Visa
510-937-5039 fax M/C

Box 23438, Pleasant Hill, CA 94523

Circle 171 on reader service card.

Portable 120 Volt AC Power In Your Car

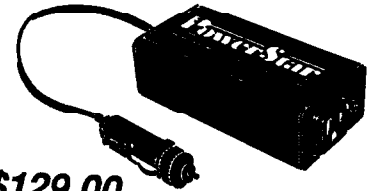

\$129.00

Power for people on the go. Now you can get convenient AC power from your car battery. The POW-200 plugs easily into your cigarette lighter and can go with you anywhere. Your car can turn into an office with the power to run a computer, phone or fax.



TOLL FREE
1-800-356-4751

SOLARMETRICS

140 Bouchard Street
Manchester, NH 03103
(603) 668-3216

Circle 99 on reader service card.

the 100/102 still work, with some screen adjustments if needed, when it comes to ROM calls, I'm frustrated. Case in point:

The February issue has some nifty stuff in the "Poking into TELCOM and BASIC" article. I would love to take advantage of some of those tricks you mentioned, but how? I'm sure that the 200 is capable of these functions (isn't it?), but I must find proper addresses for them. Basically, what I'm asking for is some information on how I can go about finding comparable addresses for the things you mentioned in the February article and how to go about converting past and future articles to the 200 (when possible.)

The 200 is a small portion of the Model T family, but we're just as committed to making our machines as useful as possible. Please help out with a "how-to" article, or publish the equivalents when possible.

Cory Hawkins
Portland, OR

The difficulty we have is finding the time to look up and check on many of these equivalents, but we do try to provide the numbers when we can. For example, see the next letter. By the way, one reason you see more information about the Model 100/102 than the 200 is simply that we receive more articles about those two. If more articles were

to come in to us, you would see more of them getting into print.

-tk

DATA RECOVERY QUERY

Regarding "Data Recovery" (February 1992, page 24), where is the BASIC program for the Model 200?

To me, a short type-in, one-line pro-

Articles like that helped me to get started.

gram such as you show for the 100/102 is better than MAYDAY.200 or XMA-DAY.200 (June 1989) stored in 2 banks.

David C. Line
Missoula, MT

You can use the exact same program as listed, except that you need to change the start and end numbers in line 13 to 40960 and 61104 (the start and end numbers of the FOR ... NEXT loop).

-tk

SOME SUGGESTIONS

So, now it's official. You're going to try to run a business and not just write/edit articles. Good luck. Here's my vote of confidence, a subscription renewal.

You want opinions on what we like and don't like. Okay, here goes (in no particular order):

* I don't like the idea of coverage for MS-DOS, BUT if you can get THEM to pay the bills and keep covering the Model T's for US, then go for it. Just don't forget us. It's easy to get seduced by the glamour, like others have. (what, more than a dozen advertisers, and they pay their bills on time? Oh joy!)

* I'm tired of the "how to connect my M100 to a PC" type of articles, but recognize their need. After all, articles like that helped me to get started. Just keep them to a minimum. Better to refer people to the back issue (and sell another copy).

I definitely want more stuff like VBA-SIC and TEXT Plus, but I hate to see the space wasted on large type-in programs. I'd rather see the space used for another article (even an MS-DOS article, ugh). Perhaps, have the listing as an extra, like the P100-to-go disk. That way if people are interested, they can order the listing, the disk, or download it from the BBS.

Make the BBS support the magazine better. I spent a number of phone calls

Instant Help On The Go



On the Keyboard...

NEW LAPTOP TEMPLATE KITS. Famous MICROREF design in a universal kit to fit today's laptop/notebook keyboards. Pocket-size guide included. Available for WordPerfect 5.1 and Lotus 1-2-3. Only \$14.95.

In the Computer...

MICROREF QUICK HELP. The only on-line guide that's comprehensive and easy to use. No more searching through complicated manuals. Available for most popular PC software. Only \$29.95.

To order call us toll-free:
1-800-553-2212
708-498-3780, FAX 708-498-0185

MICROREF
Educational Systems, Inc.
Northbrook, IL 60062

Circle 175 on reader service card.

looking for the VBASIC file but was unable to find it. Finally I gave up and typed it in. Divide the BBS directory by issue so that if I want all files for March 91, I can find them in one place. I don't know if you are familiar with it, but the Circuit Cellar BBS supports their magazine (Circuit Cellar Ink) in this manner. Just an aside, this is the only other magazine I read cover to cover, the moment it arrives.

* More articles on available peripherals. The ones on RAMPAC, DATAPAC and extRAM gave people a good look at some of the products so that they know what they are buying. Also, once people have bought the items, they need articles to help them do more with what they have. I forgot the title, but I'm thinking about the recent article on accessing a database on the RAMPAC.

* More Mike Nugent articles. Don't get lost in publishing. I liked your recent articles covering the system internals and "how things work" (or should I say, "where things are"?). More, more.

* Take the plunge back into newsstand circulation. I know it's a big, expensive step but if you approach it carefully, it should work. That's the only way you will increase circulation enough to justify charging more for your ads.

* Michael Daigle — what can I say?

He's opinionated, weird, inconsistent, strange, (a pinhead?) and generally, my kind of guy. You can't go through life serious all the time. We all need a little weirdness sometimes. If you keep him chained to his keyboard, he can't do too much harm. Keep him around.

The following is directed to Michael Daigle and his Model 300 project. Why wait for Tandy to build it, why not build it ourselves? You don't know how? Well

The ROMs should be EPROMS.

neither do I, but I'll bet there are enough people in P100's mailing list and M100SIG and Club 100 that we could find an engineer, designer or three. If people were willing to donate their time and brains, we could design a board and have a couple of hundred (or thousand?) people willing to buy it (at cost). I bet some supplier could be talked into putting together a kit of parts if they had an order for a few hundred. If someone

T-200 Enhancement

XOS (Cross bank Operating System) will enhance your Tandy 200 and allow the three banks to share programs and data. XOS will bring a new level of computer functionality at the MENU, from BASIC, TEXT, and TELCOM.

From the Tandy 200 MENU you will be able to enter memos, rename files, set alarms, display and run programs that are in other banks, and much more.

Cut TEXT from one bank and PASTE it to a file in another bank. Open a "window" while editing in bank #1, and view other files from bank #2. Disable "word wrap" while editing for another perspective of your TEXT file.

While on-line with TELCOM, display FILES and Bytes Free, enter and edit TEXT files, or jump to another RAM bank without losing the host computer connection.

BASIC programs can read/write to files in other banks. Jump to programs in other banks or bring the program into the current bank and run it.

XOS provides fundamental database entry and retrieval functions with user defined fields, prompts, and display parameters. A bargain at

\$24.95

Node Datapac Users Replace your ROM!!

RAMDSK.CO will replace the Node ROM and allow you to use one of those other ROMs you've always wanted. Retain all of the Node menu functions, plus the ability to move, kill, and name Datapac files under program control. A MUST for Node Datapac owners who have other option ROMs. RAMDSK.CO is available for the M100/M102 and T200... only **\$24.95**

N-READ.CO will allow a BASIC program to read a TEXT file stored in the Datapac without moving the file into RAM. An absolute necessity for multi-file database projects where the datafiles are kept in the Datapac. N-READ.CO is only \$9.95 but is yours for \$5 when ordering RAMDSK.CO.

For Your Amusement...

A beguiling PUZZLE/GAME program for your Tandy 200. A logical challenge that will keep you busy for many hours. Only \$10.00 for PUZZLE #3. Order with XOS or RAMDSK.CO and I'll send three additional puzzle/game/maze programs for your Tandy 200, at NO EXTRA CHARGE.

Software shipped on FDD1 (100K) diskette. All prices include shipping. Send your order with check or M.O. to:

Paul Globman
9406 NW 48th St., Sunrise, FL 33351

Circle 121 on reader service card.

didn't want to build their own, we could have a small cottage industry here, for a fee, you could have it built for you. I for one, would be willing to solder and test units for minimum wage, just so I can offset the price of my own unit. By the way, I look upon this kind of project as equivalent to my dreams of building a Hot Rod when I was a teen (i.e. something done for the thrill of it, to say "see what I built", rather than for the money).

The system would have to be modular enough to meet a variety of needs. The ROMs should be EPROMS so people could change them if they want (i.e. don't bother including TELCOM code if you never use the modem, instead put in a better TEXT editor). Also, the hardware should allow for any memory combination (minimum ROM, max RAM or the other way, if you prefer). Now what do I want in my "Hot Rod for the 21st Century"?

CPU

- Z80 based (because of the relative branch instruction). this would eliminate a lot of the machine language conflicts, and no new machine language to learn.

- fast, about 9MHz

- able to address at least 512K (1 Meg is better).

Memory

Portable 100 BACK ISSUES

With over 60 issues, and hundreds of articles, *Portable 100* is THE source for information, programs, and applications for your Tandy Portable Computer. But how do you find what you need among all those issues? The answer is the **updated Portable 100 Article Index**. Covering every issue from September 1983 to the combined summer 1989 issue, the index is designed to make it simple for you to find what you need. And at a cost of only \$9.00 (postage and handling included), you should buy one today! If you have last year's index, don't despair. Update your index by adding our special 1988-1989 Update Index. It's a bargain at just \$4 (P&H included).

And what do you do when you find an article you want? Easy. First check the back issue chart below for back issue availability. If the issue is available, just order it using the handy order form (\$5.00 each, postage and handling included). If it isn't, don't despair. **Photocopies of any article in a sold-out issue** cost just \$2.50 each. Simply list the article, or articles, by title, author, and issue, enclose payment, and in just a short time you'll have the articles in hand.

Month	83	84	85	86	87	88	89	90	91
January			Not Published						Not Published
February									
March			OUT		Not Published				
April		OUT				OUT			
May		OUT				OUT			
June		OUT							
July		OUT		OUT		combined July/Aug. issue	combined July/Aug. & Sept. (Summer 1989)	Not Published	combined July/Aug. issue
August		OUT							
September	Premier Issue								
October		OUT							
November				Not Published					
December						OUT			

Portable 100, Back Issue Department, P.O. Box 428, Peterborough, NH 03458

- Send me the 1983-Summer 1989 *Portable 100 Article Index* for \$9.00 (Postage & Handling included).
- Send me the Sept. 1988-Summer 1989 *Portable 100 Update Article Index* for \$4.00 (P&H included).
- Please send me the back issues I've indicated (\$5.00 each; shipping & handling charges included).

PAYMENT MUST ACCOMPANY ORDER

- CHECK OR M.O.
 - MC
 - AMEX
 - VISA
- TOTAL ENCLOSED _____

CARD# _____ (Be sure to include entire card number) EXP. DATE _____

NAME _____

STREET ADDRESS _____

CITY _____

STATE _____ ZIP _____

Please allow six to eight weeks for delivery

- ROM-at least 32K plus sockets for more (8 sockets would give 256k possible)

- RAM-room for at least 8 sockets of 32k. Users can start with one chip and expand as needed.

- That accounts for 512k. If you decoded the address lines for a total of 1MEG, then the user can add two more banks of 256k, as needed.

Peripherals

- Modem-by all means, but easier to leave room in the case for the owner to add their own portable modem or connect to an external, if desired. I particularly like the Worldport modem featured in a recent issue that got its power from the phone line.

- parallel and serial (in addition to modem connection) using industry standard connectors.

- Screen-I think 80x16 is okay and a 40X8 compatibility mode.

- Disk drives-support for the Tandy portable and a standard 3.5" drive (1.44M would be nice). Also, ability to connect to a hard drive (not necessarily a portable).

- EPROM burner *yes*, for saving your own permanent programs and plugging into the available sockets.

- expansion connector-a 'docking port' for connecting to things (like

hard drives and external monitor) when at home.

Software

- BASIC-of course. Preferably compatible with the existing M100 version. BUT with a full compiler
- simple database and spreadsheet (or programmable calculator).

- a terminal program, with at minimum, XMODEM but would be changeable protocols (i.e. reference to external protocol programs). Background up/down loads would be nice.

- a good text editor. The power of James Yi's *TEXT Plus* as a minimum starting point.

- print formatter and spooler (background printing)

- assemble/debug program.

- Multi-tasking, even if only the print spooler, pop-up utility, kind. i.e. I want to pull up my calendar in the middle of editing a letter, pull up a help screen in the middle of a telecomm session or even edit two files at once.

Is all this possible? I think so. I'm doing some serious looking at a processor chip called the Hitachi HD64180. It is Z80 compatible, can address 1 Meg, has built in Memory Management Unit (for accessing more than 64K), has built in

dynamic RAM refresh, and has two serial ports. Circuit Cellar Ink and Steve Ciarcci (formerly of *BYTE* magazine) have done a number of projects using this chip. They even have a compiled, multi-tasking Basic available, as well as Z-system (CPM compatible) DOS for the boards. I'm still debating between buying their boards or trying to build my own. Their prices are a bit high, but they're dealing with a limited market so they have to make their development costs from smaller volume (we've heard this explanation before, haven't we?). I feel this processor would be well suited to a "Hot Rod" type project.

So, there are my thoughts on *Portable 100* and a successor system for my Tandy Model 102.

**Eric Sakara
Winnipeg, Canada**

We'll pass your comments on to Daigle, but he has a different job now that is eating up all his time, so we won't be hearing from him as frequently.

Your other comments are taken to heart. We'll do the best we can with the space we have, but we do have to put in the listings. Readers get VERY annoyed when we don't put them in and refer them to either the BBS or a purchasable disk (the overseas readers find both those solutions hard to handle).

-tk

COMPATIBILITY: All computers.

Leisure Communications

The Portable 100 BBS is better than ever.

by Chris Courson

If you haven't been on *Portable 100 BBS* lately, you'll be surprised! *Portable 100 BBS* is a Bulletin Board System provided by our beloved magazine as a free service to its readers. All you need to use this service is your Tandy portable computer and a telephone. My name is Chris and I'm your System Operator (SYSOP). My real job is an Electronics Technician in the U.S. Navy. I SYSOP for fun.

Portable 100 BBS has made a big change for April. Call it spring cleaning. Major surgery was conducted on the menus and the board was reconfigured so that it could be expanded and be easier to use. These changes took place because you the users asked for them. If you have a suggestion just drop me a line. The board has nine message conference areas that now include sections for Hams and the Tandy Color Computer. We have programs for the complete line of Tandy portable computers and MS-DOS machines. Best of all, there is no charge to take them.

It is easy to get on-line with *Portable 100 BBS*. Simply follow the instructions in your user manual for setting up. Your communications *STAT* should be 300 or 1200 baud (for Model 100,102,200,600 using internal modem in telcom set *STAT M8N1E*). The board uses eight bits, no parity, one stop bit, and Xon/Xoff protocol. Once you are online and you see "FIRST NAME:" just answer the questions. The board uses one-key commands, that is, from a menu list you may select an option by pressing the character between the < >. If you need help

just press H. To give you a graphic idea of how the board menus are laid out, see figure one.

Remember, this is leisure communi-

**You can download
all of them
if you want!**

cations. Relax and enjoy it. You have 30 minutes at a time to do anything you wish. If you need more time just call right

back. You can't hurt the board so feel free to experiment. If you change your terminal settings and cannot make heads or tails of what is on your screen simply re-logon as Fred Flintstone or something and leave me a note and I'll fix it for you. You can use your temporary name until I can fix your problem. When you log on as an actual user you must use your real name. This is a clean all American BBS so, please, keep everything at a G-rating.

If you want programs, we have them. You can download all of them if you want! Don't feel guilty. Those programs are there for you. Eat, drink, and be Mary or any other woman you choose to impersonate. Most of all, enjoy the board.

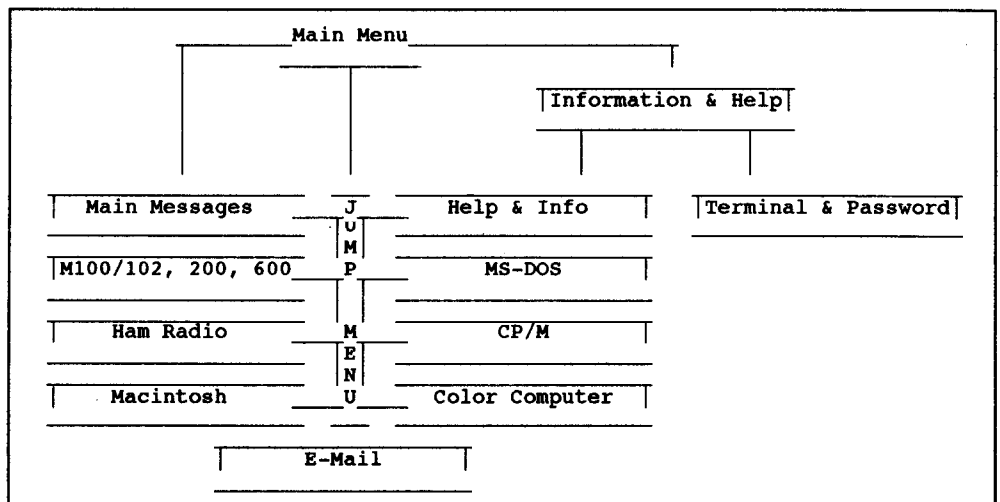

Figure 1. A map to the Portable 100 BBS.

COMPATIBILITY: MS-DOS portables (and desktops).

XSEND.COM — Xmodem Send Program

For those times when you want to move files from one machine to another and don't have a terminal program to help.

by John Comeau

While not expressly about portable MS-DOS computers, we felt this article would be of interest to everyone who wants to transfer files and programs between computer through the RS-232 ports

Finally, I bought myself a Tandy 1000 SL/2 MS-DOS computer. The store manager let it go for \$200, probably tired of dusting it off. Now when I got it home, I was sure, I could pop one of my industry standard 5.25-inch floppy drives in there and be able to use all the software I had on my older clone. No such luck. The internal cable was too short to reach the card edge connector on the drive. Even had it been long enough, I was doubtful enough about the interface to be unsure whether I wanted to risk both computer and drive going up in smoke.

So, I decided to send files to the Tandy using the RS232 port.

So, I decided to send files to the Tandy using the RS232 port. First, I relearned that the *DOS COPY* command doesn't work with binary files over the *COM* port. Then I found out that *TELCOM ASCII* mode transfers don't handle eight-bit files either. *XMODEM* would, but I didn't have an *XMODEM* for my other machine. Now, I know that I could have gotten one from CompuServe or some other BBS. But I'd had the *XMODEM* docs lying around for so long and hadn't done anything with them but a stupid, S-L-O-W *BASIC XMODEM* receive program for the Model 100. So, I decided to write a minimalist assembly language *XMODEM* Send program for the PC, using the *DEBUG* assembler as I did in my February article.

After three nights of blurry-eyed hacking, I came up with what you see in the listing. This time I included the *DEBUG* commands right in the listing, because last time, using *QASM* (the number of spaces has to be just right), things got messed up

```

a
;xmodem send program, no trills, direct connect only
    jmp     200     ;skip past data area
;static storage for SOH character, which stays the same,
;and block number, which doesn't:
    db     1,0,0
    dw     0,0,0,0,0,0,0,0,0,0,0,0,0,0,0,0
    dw     0,0,0,0,0,0,0,0,0,0,0,0,0,0,0,0
    dw     0,0,0,0,0,0,0,0,0,0,0,0,0,0,0,0
    dw     0,0,0,0,0,0,0,0,0,0,0,0,0,0,0,0
;block check character follows 128 bytes of data
    db     0
;word data area
    org     1c0
;timeout count
    dw     0
;retry count
    dw     0
;number of chars in last GET
    dw     0
;storage for file handle
    dw     0
;start program area
    org     200
    mov     bx,80     ;point to input character count
    mov     al,[bx]   ;find out what it is
    cbw
    add     ax,bx     ;almost points to last input character
                    ;(CR)
    inc     ax         ;now it does
    mov     bx,ax     ;can't use AX as pointer
    mov     byte ptr [bx],0 ;clear it
    mov     dx,82     ;point to first char after <SPACE> or
                    ;<TAB>
    mov     ax,3d00   ;open for read only
    int     21         ;call DOS "open file" function
    jnc     21d        ;go on if successful
    mov     ax,4c01   ;otherwise return with ERRORLEVEL 1
    int     21
    mov     [1c6],ax  ;save file handle
    stc
    call    2a0        ;tell subroutine to wait for NAK
                    ;wait for receiver to signal it's alive
;send_file_loop:
    mov     di,106    ;point to beginning
    mov     cx,81     ;bytes to clear
    xor     ax,ax     ;clear accumulator
    rep
    stosb             ;and clean the block
    inc     byte ptr [104] ;next block number
    mov     dx,106    ;point ds:dx to read buffer
    mov     cx,80     ;grab 128 bytes from file

```

Continued.

Listing 1. The XSEND program, as it should be typed into DEBUG.

GOOD MEMORIES

We still make 'em . . . since 1983

Model 100 8K module \$29

NEC 8201 8K module \$29

Tandy 200 24K module \$59

Tandy 600 96K module \$99

NEC 8201 128K cartridge \$159

NEW SUPER SMALL DESIGN
w/4 banks of 32K RAM.

WP-2 RAM expansion \$CALL

Purple Computing

2048 Southside Rd.

Murphy, OR 97533

1-800-732-5012

Visa and MasterCard accepted.

Circle 55 on reader service card.

Ultra-thin Gender Changers!

Compatible connections in half the
space! Drawing is ACTUAL SIZE!



9-pin M/M or F/F \$12.00ea

25-pin M/M or F/F \$15.00ea

Portable 100—Hardware
P.O. Box 428, 145 Grove St. Ext.
Peterborough, NH 03458-0428
(603) 924-9455

Visa, MasterCard, Amex accepted.
Please allow 6-8 weeks for delivery

Circle 117 on reader service card.

PostScript™ for the LP 1000!

PageStyler...

"See page 36
in your
1990 Computer
Catalog."

DESTINY

Destiny Technology Corp.
408/262-9400

PostScript is a trademark of Adobe Systems Inc.

Circle 5 on reader service card.

```

mov     bx,[1c6] ;restore file handle
mov     ah,3f   ;read from file
int     21     ;dos read function
jnc     247    ;move on if successful
mov     ax,4c02 ;load 2 into ERRORLEVEL
int     21     ;and abort
;now calculate the checksum
mov     [1c4],al ;save actual byte count
xor     ax,ax  ;now clear for block check computation
mov     si,ax  ;clear index
mov     bx,dx  ;get start of data into secondary
                    ;register
;checksum_loop:
add     al,[bx+si] ;compute checksum mod 256
inc     si     ;move pointer up till done
loop   250    ;loop for all data characters
mov     [186],al ;store at end of packet
mov     al,[104] ;calc ones complement of blocknum
neg     al
dec     al     ;neg-dec combo = 8085 CMA
mov     [105],al ;complemented block number
;send_block:
mov     cx,84  ;total packet count=132 characters
mov     si,103 ;move index to first byte of block
;send_block_loop:
call   28e    ;send a byte
loop  268    ;and loop till entire block is sent
call   2a0    ;wait for ACK
jc     262    ;if NAK, resend the block
cmp    byte ptr [1c4],80 ;were there 128 bytes in last
                    ;GET?
jz     224    ;if not, loop to send whole file
mov    byte ptr [106],4 ;place EOT into packet space
mov    si,106  ;and point index to it
call   28e    ;send it
call   2a0    ;wait for ACK
jc     27e    ;repeat if error
mov    ax,4c00 ;otherwise return with ERRORLEVEL 0
int    21
;subroutines start here
mov    cx,1    ;com2 select
mov    ah,3    ;"get status" command
int    14     ;BIOS query
test   ah,20  ;ready to transmit?
jz     28e    ;if not, try again
lodsb ;get the current byte and inc index
mov    ah,1   ;SEND command
int    14     ;to BIOS
ret    ;and that's that
;wait forever for ACK or NAK. Check for ^C or ESC
pushf ;save flag, carry indicates NAK expected
mov    ah,0b  ;get keyboard input status
int    21     ;from DOS
inc    al     ;anything there?

```

Continued

in the typesetting of the magazine.

Those of you who have written XMODEM programs will quickly notice how much I left out — timeouts, CANCEL handling, CRC option — but as Ward Christensen himself said, "it was just a quick hack I threw together..." I could eliminate timeouts because I check for ^C's (DOS handles BREAK, but I run DOS from a dumb terminal off my COM1 port — but that's another story). The single-byte checksum which is the original XMODEM standard was sufficient because I was using a short direct-connect cable and had no intention of using it over a noisy telephone line. I trusted the Telecom program for timeouts but, again, I could always ^C out of it if I had to.

The final block can have up to 127 "extra" bytes in it.

HOW IT WORKS

Those of you who up to now have been blissfully ignorant of how XMODEM works, let me very briefly fill in some of the blanks. One side sends fixed-length 132-byte packets made up as follows: one-byte packet header, SOH (01h); block number, starting at one (01h), incrementing by one to packet #255 (0ffh) and then wrapping around to 0; the one's complement of the block number, starting at 254 (0feh); 128 bytes of binary data; and, finally, the checksum, which is the byte sum of all the data bytes (ignore any carry). The final block can have up to 127 "extra" bytes in it because of this fixed-length "feature", which makes this protocol the transfer method of choice for virus writers — you will notice that I wipe the block clean before each packet is loaded so that instead of "garbage" you will have nulls after the end of the file.

While this side does all the work, the other side simply extracts the data, sees if the checksum matches, and, if so, ACKs (acknowledges) such to the sender. If the checksums don't match, or if the receiver times out, it NAKs (negative acknowledges) the sender. These are one-byte ASCII characters, corresponding respectively to 06h and 15h. Tying up the loose ends,

About Your Subscription

Your copy of Portable 100 is sent via second-class mail. You must notify us of your new address when you move. Please allow two months for processing. Sorry, we cannot be responsible for sending another copy when you fail to notify us in time.

Your mailing address also shows an "account number" (first four numbers on the top line) and the subscription expiration date (last six numbers on top line). Please give us this account number and expiration date when renewing or corresponding with us. It will help us help you better and faster.

Simply send your new address and the mailing label from a previous issue to:

Portable 100

145 Grove St. Ext.

P.O. Box 428

Peterborough, NH 03458

or call us at:

(603) 924-9455

AFFORDABLE HARD DRIVES FOR YOUR LAPTOP

THE QUICKBRICK ... connects directly to the expansion bus, providing the best performance among all external drives.

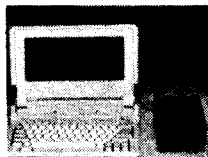

Toshiba, Tandy, IBM Convertible, NEC, Sharp, Kaypro, Dataview, Zenith - You name it!

Now Only \$395 /20 MB.

Systems Peripherals Consultants
7950 Silverton Ave., #107
San Diego, CA 92126
619/693-8611

Circle 18 on reader service card.

WEETAXTM The Weekly Tax Program

For periodic maintenance of input to your personal income tax return.

- table-driven panel fields
- your labels and default data
- optional, prompted annotation
- year-to-date summary printout
- resets to start next year
- only 377 bytes reside in RAM
- standardizes format
- promotes time management
- provides current accounting
- avoids the year-end crisis
- keeps you in control

DVI: \$44.95 ppd PDD: \$49.95 ppd for UltraSoft Disk PowerTM 100

Introducing in March 1989: Portable 100.

Software Versand, Points West No. 15B
3131 W. Cochise Dr., Phoenix, AZ 85051
Phone: 602-997-1523 1989 TMO

Circle 128 on readers service card.

the receiver must first initiate the transaction by NAKing the sender until the sender wakes up. And finally, the sender finishes the transaction with an EOT (04h) which the receiver must also ACK.

My program uses port 2 on my LASER XT clone. I set the port speed and parity beforehand using the DOS MODE command. The assembly program should be typed in exactly as is (except that comments can be left out), and assembled using DEBUG XSEND.COM <XSEND.ASM. The "<" is the DOS redirection character which basically means "take your input from this file rather than the keyboard".

I've got more important stuff to work on, and this little hack has served its purpose.

If you want a listing file generated, use the ">" redirection to send the listing to a file or the printer. For example, DEBUG XSEND.COM <XSEND.ASM>XSEND.LST sends the listing to a file, whereas DEBUG XSEND.COM <XSEND.ASM>PRN: sends it to the lineprinter. After assembly, run the program simply by typing XSEND FILNAM.EXT. That is, to send the program A85ASM.EXE from one computer to the other, just type XSEND A85ASM.EXE on the sending computer. Then go over to the other, in my case the SL/2, crank up XMODEM, which meant to select TELECOM from the desktop, SET the proper speed and parity, select TRANSFER, and hit the right buttons for XMODEM RECEIVE. The display on the target system should show the progress, or lack thereof, at least as well as TELECOM does. When finished, TELECOM leaves you in terminal mode, and XSEND simply exits to the DOS prompt.

Lines 88, 120, and 133 all have the command MOV DX,1. If you wish to use this program with port one (COM1) rather than port two as I did, you must change these lines to read MOV DX,0. Now, of course I could have made it a variable in the data area, or even a command line option. But I didn't, it works fine

```

jnz 2c0 ;if not, check for NAK
mov ah,1 ;else see what we got
int 21 ;from DOS
or al,al ;function or special key?
jnz 2b3
int 21 ;get scan code if so
;check what was input. abort if ^C or ESC
cmp al,1b ;ESC?
jz 2bb ;if so, exit_3
cmp al,3 ;^C?
jnz 2c0 ;if not, check for NAK
;exit_3:
mov ax,4c03 ;exit with ERRORLEVEL 3
int 21
;check_NAK:
popf ;retrieve ACK-NAK flag
jc 2c5 ;jump to NAK test if carry set
jmp 2dc ;else to ACK test
mov dx,1 ;com2 select
mov ah,3 ;"get status" command
int 14 ;BIOS query
test ah,1 ;something in receive latch?
stc ;set NAK flag in case answer is no...
jz 2a0 ;if not, keep waiting
mov ah,2 ;RECEIVE
int 14 ;from BIOS
cmp al,15 ;NAK?
stc ;set NAK flag in case answer is no...
jnz 2a0 ;keep waiting if not
ret ;otherwise ready to proceed
;check_ACK:
mov dx,1 ;com2 select
mov ah,3 ;"get status" command
int 14 ;BIOS query
test ah,1 ;something in receive latch?
jz 2f3 ;if not, keep waiting
mov ah,2 ;RECEIVE
int 14 ;from BIOS
cmp al,6 ;ACK?
jnz 2f1 ;if not, block must be resent
ret ;otherwise ready to proceed
stc ;indicate problem with carry flag
ret
jmp 2a0 ;go back thru wait routine

rcx
2f5
w
q

```

End of listing

for what it is, and that's that. I've got lots more important stuff to be working on, and this little hack served its purpose. If it can help anybody learn something, that's just icing on the cake.

COMPATIBILITY: All computers.

The Ultimate Shipping And Carrying Case

Are you looking for a shipping and carrying case strong enough to protect your computer from anything?

by Beau Keller

Shortly after I bought my first Model 100, I realized the danger of just carrying it around. It would be very easy to scratch the screen or break the housing, so I started to carry my Model 100 in my briefcase. I still had to be very careful with the computer and the disk drive would not fit in the briefcase.

Then I considered the crush formula, which states, "if I crush the keyboard, damage the screen and or damage the computer, I get to fix it!" Two events occurred that made me realize I had to find a better case for carrying my Model 100. First, I started renting my Model 100 and needed a case that would look professional. Second was the crush factor on my current briefcase: the side burst from the thick load. I knew I had to find the right case to fit my needs.

I am always on the move, carrying my Model 100 with me, or renting them. (As I said, I sometimes even rent my Model 100 to other people.) I needed a case that would be sturdy, very sturdy. I might want to ship my Model 100 and disk drive via the airlines, (Oh, no. Not the airlines!) or throw the case on top of a large pile of other equipment that would be delivered to a job site. To reduce stress from the worry factor, I had to find and use a case that would be virtually indestructible.

I started to look at almost anything that would be large enough for both the computer and the disk drive. They don't make briefcases large or sturdy enough for both pieces. Most of the cases available for the Model 100 are very good, but soft sided. For a casual user they would be just fine; light weight and convenient.

They would not fit my needs for travel and shipping without the possibility of shipping damage.

Then, one day, a friend stopped by with a new (to me) kind of briefcase. He was a video editor for a national network. The briefcase he carried had a big circle on the side with large letters saying "Anvil." We talked about Anvil. I learned that Anvil is the manufacturer of custom fit shipping cases for just about everything, from video equipment to rock band equipment to computers.

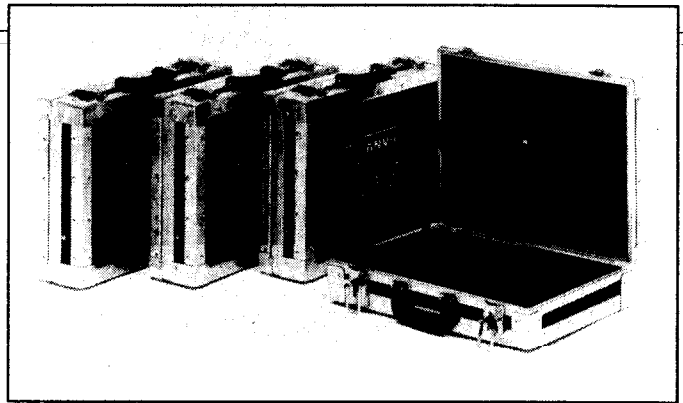

The Anvil Promotional briefcase (model shown does not have the Anvil logo).

I had to find and use a case that would be virtually indestructible.

This sounded too good to be true. I called Anvil. Yes, they made a case the size of a briefcase, but the cost was \$110.00. A little steep for my needs. But, after talking with them, I learned about

the "promotional briefcase."

The promotional briefcase sells for \$60.00 and has the "Anvil" name on the side in a big circle. These cases are sold to Anvil distributors, to show customers how well the cases are built. They are built with aluminum edges, a key lock and steel corners. These promotional briefcases are sold to customers at conventions and at the larger music stores in limited numbers (you must ask).

Only one draw back, the briefcase weighs 15 lbs. (empty). I would think it would be much too heavy for common use. The big plus is protection when shipping and moving. Short of throwing the case from a moving car or dropping it from high places, you can't destroy an Anvil case.

I bought two Anvil cases, (I have three Model 100's), and foam padding for both. Although I could not find static sensitive foam large enough for the case, I have had no static problems. I started to fit the case. After fitting the bottom of the case with 1/2" foam, cut to size, I found the Model 100 would fit in the case verti-

TANDY LIQUIDATION

TANDY MODEL 100 \$ 199

With **32K RAM & 160K BUBBLE MEMORY (Used)**

160K Bubble Memory Expansion \$ 89

For TANDY Model 100 or 102 Computer (Used)
Mgfr. Sight Sound includes Power Supply

DMP - 105 Printer (Used) \$ 59

Blue Cloth Carrying Case (New) \$ 29

Multiplan ROM SpreadSheet \$ 19

(Without Instruction Manual)

HUGE LIQUIDATION

TRS-DOS HARDWARE & SOFTWARE

CALL - WRITE - FAX - Dial BBS

FOR LIQUIDATION LIST

BEFORE IT IS TOO LATE

**COMPUTER
RESET**

(214) 276-8072

P.O. Box 461782

Garland, TX 75046-1782

FAX & BBS (214) 272-7920

TERMS: COD or Prepaid, No Credit Cards

Shipping Not Included - LIQUIDATION ITEMS SOLD AS IS

Circle 154 on reader service card.

cal surrounded with 1/2" foam around the edge. (All the foam was attached with spray mount.) It would fit perfectly. Although 1/2" of foam padding is not recommended for maximum shock absorbency, there is little to worry about. The Model 100 can absorb quit a bit, all by itself.

Now, the computer was in place. What about the portable disk drive? Yes, I had plenty of room for 3" of shock absorbing foam. Much more than the 2" minimum recommended thickness for

**I had plenty of
room for shock
absorbing foam.**

the shock sensitive portable disk drive. I couldn't believe it. I even had room for legs, disk drive cable, extra batteries, ac adapter and a box of disks! I had found even more room to fit standard files into the briefcase pouch. After engraving my name on the outside of the aluminum

frame, the briefcase was ready for anything.

With the Anvil briefcase standing upright, the dimensions are 16-7/8" wide by 12-5/8" tall by 3-3/4" deep. (These are all inside dimensions.) From the measurements listed in the catalogs, the Anvil case should accommodate all the Tandy Portable computers, except the 1400 series.

With the briefcase fully loaded for shipping, it weighs in at an arm stretching 22 lbs. (Case, Model 100, portable disk drive, cables, batteries, and ac adapter). Then I considered the weight equipment formula, which states, "if the computer is damaged in shipping, the case wasn't good enough. I get to fix the equipment!" I realized I don't care how much the case weighs. At last, I could have my Model 100's on the road and not worry about damage!



PRODUCT SPECIFICATIONS & SUPPLIERS

Anvil Promotional Case — \$60.00

Anvil Cases
15650 Salt Lake Avenue
City of Industry, CA 91745
(800) FLY-ANVIL (800-359-2684)



PC-PDD

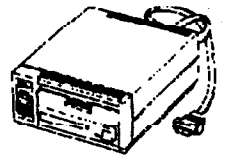

PC <---> Tandy Portable Disk Drive

Tandy WP-2 and Model 100/102/200 owners! Do you have an IBM PC or compatible? Are you tired of squirting your files through a null-modem cable? Tired of setting communications parameters? Of turning your PC into a Portable Disk Drive (PDD) emulator?

PC-PDD is the first program which lets you attach your Tandy PDD to your PC and support the WP-2 and Models 100/102/200 as well as both PDD models (original 100K and the current 200K Model 2)!

- o Copy files to/from the PDD
- o Two bank support for PDD-2
- o Format, kill, rename files
- o "Point-and-shoot" interface & directory navigator
- o DOS file editor & browser
- o and much more!

PC-PDD requires an IBM PC or 100% compatible, 512K memory and a serial port. Send check or money order for \$49 + \$3 S&H (CA residents add 7.75%) or circle the reader service number below. A F-F gender adapter is required. Add \$7 if you need one. Specify if your PC has a 25 pin or 9-pin port.



MicroMime

P.O. Box 28181

Santa Ana, CA 92799

CIS 70346,1267

Fax/Phone (714) 545-1765

MCI 200-3496

Circle 149 on reader service card.

44

**PORTABLE 100
Back Issues
for only \$99.95!**

Now you can buy all 44 available back issues covering **September 1983 to Summer 1989** for the bargain basement price of only **\$99.95!**

Call **603-924-9455** and ask for the **Portable 100 Back Issue Special**. Or write to Portable 100, POB 428, Peterborough, NH 03458-0428, and enclose your payment (Check, M.O., MasterCard, Visa, or AMEX numbers). U.S. shipping and handling included, Foreign shipping is \$20 more, surface only. **Order now! Supplies are limited!**

COMPATIBILITY:

MS-DOS portables and desktops.

Keep Your Software Safe

*Computer viruses, like human ones, are a constant threat.
Recovering from one can take days.*

And if you aren't careful, one can sneak in and destroy your files.

by Terry Kepner

Michaelangelo. It's sad that such a famous name is linked with such a destructive activity. That someone would want to hurt people he doesn't even know just to show that he can is sick, but it is a fact. As a result, computer users must always be vigilant against these insidious sick minds. Thanks to the publicity in March, almost everyone is now aware of the threat of computer viruses.

Just because you never buy or use shareware or public-domain software does not keep you safe. Even commercial software gets infected. Several years ago a major spreadsheet company distributed their product with an infected program for almost six months to many tens of thousands of customers. Even Microsoft has had problems keeping viruses out of their Beta Test software. Hardware companies get caught, too, as Leading Edge discovered with the Michaelangelo virus, selling over 500 computers with the virus already installed on the hard drives. So, no matter how careful you are, you can still end up with infected software.

Unfortunately, the threat doesn't come once a year, as some people seem to think, but is a constant danger. New viruses appear everyday. And having the latest virus protection software is not really the answer, as Michaelangelo proved. Virtually every major virus-detecting software package had to issue an update to cover this new threat.

That presents a problem for computer users. The virus-detector that finds all the current viruses (over three hundred), might not find the new virus released last Tuesday.

How do you keep up? Trying to buy every update as it becomes available isn't

the answer, you'll just spend all your money. And still read about other packages that detect viruses yours misses. (Someone, usually in marketing, is always running a comparison and saying "Ours finds x-number viruses more than our competitors!") The only difference between them might be that the other one came out a month after the one you have. Not to mention the differences in definitions used by the companies.

For example, Central Point Software's *Anti-Virus* claims to scan for

Mining the shareware/BBS sources for virus detection software is a hit-or-miss affair.

400 viruses while IMSI's *VirusCure Plus* looks for 240 viruses and 893 variations. While *Anti-Virus* also searches for virus variations, it doesn't mention how. So, which can find more?

Trying to mine the shareware/BBS sources for virus detection software is a hit-or-miss affair. You never know if the new software from an unheard-of source is better or worse than the software you already have. Plus, you might be buying a Trojan Horse program that will hide

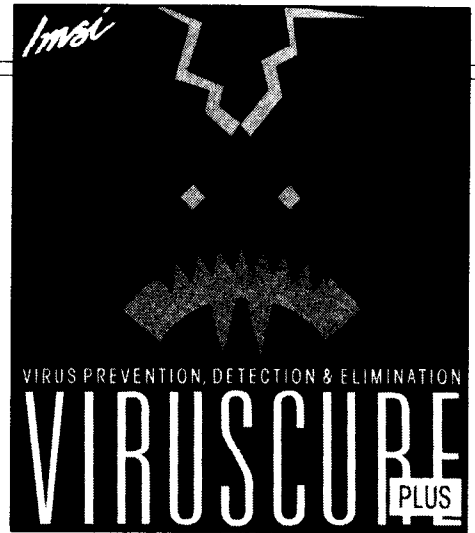

Photo 1. *VirusCure Plus*' packaging.

like a timebomb for months before revealing its true nature. If the commercial outfits have trouble keeping their products clean, the shareware/freeware people can't have it easier.

The best answer is to use only commercial software. But which software?

TWO SOLUTIONS

The best virus detectors operate by using data files with *signatures* that detail how to find the virus and disable it. As a result, updating them is simple: you just get a new data file.

The two programs mentioned here both operate this way. Updates are available to registered users via modem, from a list, or by paying an update fee. The modem method offers the fastest and most cost-effective way of keeping your software up-to-date. Calling the company once a month, or whenever you buy new software, and downloading the latest signature file will keep you well prepared for any virus that might appear, before it can do any damage.

USE YOUR DESKTOP COMPUTER AS A DISK DRIVE FOR YOUR M-100.

New
IBM, MS-DOS
version works
over the phone!

Disk+

on Snap-In™ ROM

NOW
AVAILABLE
ON
M-200

Try *Disk+* for 30 days. If you aren't as excited as we are, return it for a full refund.

When we designed *Disk+* we did it out of necessity. We wanted a way that we could just connect a Model 100 to our desktop computer with a cable and save files onto the desktop's disk drive. We wanted it to be so simple to use it would be self-explanatory.

Picture this. *Disk+* comes to you on a Snap-in ROM and a diskette for your desktop. You take a quarter and open the little compartment on the back of your Model 100. Then you just press the ROM into the socket. *Disk+* appears on your main menu just like a built-in.

You connect your Model 100 to your other computer using an RS232 cable (available from TMNE for only \$20).

You just place the *Disk+* diskette into the desktop's drive and turn on the computer. It powers up automatically and says "awaiting command" on your desktop's screen. Then you just put the widebar cursor on the Model 100 main menu on *Disk+* and press ENTER. You are shown your RAM files arranged just like the main menu.

To save a file to your other system's disk drive, you just move the widebar cursor to the file you want to save and press ENTER. It is saved instantly with no further action.

To look at the disk directory, you just press a function key on your Model 100. You see immediately the disk directory on your Model 100 screen, and it is arranged just like your Model 100's main menu.

To load a file from the diskette to your Model 100, you just move the widebar cursor to the file and press ENTER. The file is transferred to your Model 100's RAM instantly. You can press F8 and go back to the main menu, and the file you loaded from diskette is there, ready to use.

It is so nice to be able to keep your documents, programs (both BASIC and machine code) and *Lucid* spreadsheet files on the diskette, and bring them back when you need them. All files are ready to run or use with no changes or protocol by you.

If you have access to a desktop computer and don't have *Disk+*, then evidently we have done a poor job telling you about it.

All files and programs that you load or save, go over and come back exactly as they are supposed to be because of full error checking. This guaranteed integrity is really a comfort. *Disk+* is wonderful in so many other ways. For example, you can do a "save all" of all your RAM files with just a touch of a function key. That group of files is saved on the diskette under a single filename with a .SD (for subdirectory) extension. Any time you want, you can bring back all those files at once, or just one or two if you like, again with one-button ease.

Disk+ takes up no RAM. That's zero bytes either for storing the program or for operating overhead.

What really excites most *Disk+* users is text file cross compatibility. Your Model 100's text files are usable on your desktop computer, and your desktop's text files become Model 100 text files.

This means you can write something on your Model 100, and with *Disk+* transfer it

instantly to your desktop and start using it right away on your bigger computer. Or the way we like to work is to type in a document on the desktop computer and then transfer it to our Model 100 with *Disk+*. Then we print out the document, beautifully formatted, using WRITE ROM.

Disk+ works with just about every micro sold, from IBM PC and its clones, to all Radio Shack computers (yes, all), to Apple II, Kaypro, Epson and most CPM. Just ask us. More than likely, your computer is supported.

Incidentally, hundreds of Model 100 owners have gone to their Radio Shack stores and bought a color computer because it is so low priced, and with *Disk+* they have an inexpensive disk drive.

And if that weren't enough, how about this: *Disk+* also provides cross-compatibility between different computers like IBM, Apple or the Model 4 using the Model 100 as the intermediary device. Quite a feature!

The snap-in ROM is really great because you can use other ROMs like *Lucid* or WRITE ROM. They snap in and out as easily as an Atari game cartridge and you never lose your files in RAM.

Anyone who ever uses *Disk+* simply can't do without it. But so many times we have had new users call us and say, "Wow! I had no idea when I ordered it that *Disk+* would be so fantastic. I just couldn't believe that I could use my desktop computer's disk drive with my Model 100 just like it is another main menu."

That's why we sell *Disk+* on a thirty-day trial. If you aren't completely satisfied, return it within thirty days for a full refund. Priced at \$149.95 on Snap-in ROM. MasterCard, Visa or COD.

1-603-924-8663

Distributed by:

Tri-Mike Network East

P.O. Box 372, Peterborough, NH 03458

Please add \$5.00
shipping and handling
charge to your order.

Circle 73 on reader service card.

Another fine product from the innovative people at PCSGI

Both programs provide detection (finding viruses and infected programs), cure (removing the viruses from your disk drives), restoration (fixing corrupted files, in most cases, so that they can still be used), immunization (scanning new disks and files for viruses), and regular checkups (creating special signature files that describe your system to the detection program and making it easier to detect tampering by viruses, known and unknown).

Viruses can be divided into two categories: known and unknown. The known viruses have been positively identified and their signatures defined. These are easily found and removed. The unknown viruses are another matter. Fortunately for users, most new viruses are simple variations of existing viruses, making their detection a matter of looking for certain tell-tale signs in scanned files. When the signs are found, they are compared with the signatures of known viruses until a match is made with one or more.

With this information, the program can remove the virus properly, and, in many cases, repair the damaged file. Viruses that change code inside the file or overwrite parts of the file cause sufficient damage that restoring the file is impossible. Other viruses, that add code to the beginning or end of a file, make it possible to recover the original file and restore it to usefulness.

The problem is with the truly new viruses. Without the signs to alert them, the virus detecting programs cannot find these new breeds. Hence, the constant flow of updates.

VIRUSCURE PLUS

VirusCure Plus offers three separate programs. Two are memory-resident programs that scan your system for viruses every time you turn it on and then hide in memory watching your system for any signs of virus activity. They require 25K of resident RAM. The third program is operated from the DOS prompt and scans memory and your system for virus activity. It reports what it finds, if anything, then exits back to DOS.

Default Yes/No settings for the system, kept in a configuration file on your disk, are: automatic virus removal, backup of infected files, search subdirectories in addition to the main directory, check read-only files, check overlay files, and network operation.

You can, of course, put the programs in a .BAT file for automatic operation with any special scanning options you decide are necessary, overriding the

default settings. These include automatic virus removal, backup files that are disinfected, run without prompts unless a problem is found, display a help list, monochrome operation, network operation, check overlay files, check read only files, and check subdirectories.

For example, by typing `A:/CURE/d C: D. E:/BIN E:/WORD` you can tell *VirusCure Plus* to scan disk drives C and D, and subdirectories E:/BIN and E:/WORD on drive E. The /d tells *VirusCure Plus* to report only when it finds a problem.

The two memory resident programs can be turned off and on from the DOS prompt to prevent memory conflicts with other memory-resident programs. If you do not want them monitoring your computer system, you do not have to load them.

Actually using the program is simple and requires absolutely no reading of the manual. Just type `CURE` and press `ENTER`. The program will ask for the drive and/or subdirectory you want to scan.

Immunization works by adding a short program to your normal program.

The configuration file and command line options are for those who want to customize the programs to their specific system and needs.

The manual is simple, a twenty-two page five by seven-inch booklet, that details the various options and error messages. On disk is a file listing all the viruses and the type of damage they do to your files.

Upgrades are free for two years from your registration.

ANTI-VIRUS

Central Point Software's *Anti-Virus* is a more complicated program, with many more options and customization selections. Like the other package, this one has a memory-resident program that keeps a constant watch on your system, but has two versions. One is 8K and the other is 22K. The larger one, *VSAFE*, has configurable options for what it checks and when and maintains a constant

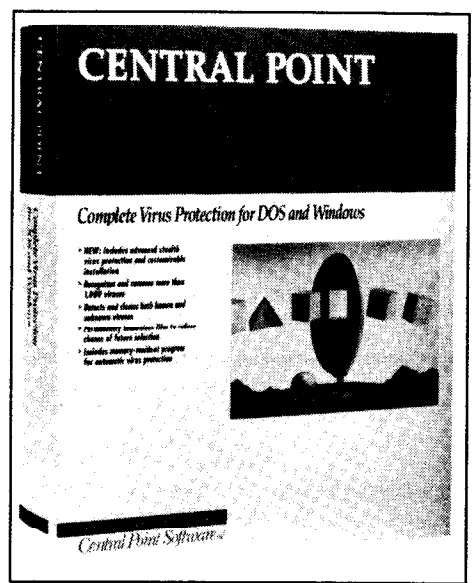

Photo. 2. Central Point Anti-Virus.

watch. The smaller one, *VWATCH*, for use when memory is at a premium, simply checks programs as they are executed and disks when they are inserted. Both only alert you to a problem.

VSAFE options settings let you toggle watching for low level format operations, attempts by programs to stay in RAM, preventing disk write operations (handy for testing new software), checking files as they are opened, checking the boot sectors of disks as you put them in the disk drive, preventing programs from writing to the boot sectors of disks, and stopping programs from modifying executable files. You can preselect these options, or turn them on and off from the DOS prompt as you need them.

A third program, *BOOTSAFE*, checks your boot tables and disk partitions for problems.

The main program, called *CPAV*, can also be operated automatically from the DOS prompt, letting you incorporate it into your *AUTOEXEC.BAT* file for systematic maintenance without using the memory resident programs.

During installation *CPAV* builds its configuration file and the support files that contain checksums for the programs on your hard disk. The configuration file holds the default settings used by *Anti-Virus*: verify files, create checksums for new files added, create checksums for a floppy, enable/disable sound, create backup of infected files, make a report, use prompts if an infected file is found, fast detection (scan only the most likely areas a virus appears instead of entire files), check all files instead of only executable files, detect viruses only, network use, display menus, password protection, and display a special (for

companies who want users to call a special department or individual if there's a problem).

The final step of installation is creating an emergency disk. This disk lets you recover from a fatal infection that destroys your boot sectors, partition tables, or CMOS computer memory configuration.

Also, during installation, you can make *VSAFE* or *VWATCH* part of your *CONFIG.SYS* file where they can catch a corrupted *COMMAND.COM* file before it boots your computer and causes further damage. Doing this makes it impossible to remove them from memory without altering the *CONFIG.SYS* file and rebooting the computer.

Anti-Virus uses Windows-style menus and offers short or long versions. The short menu lets you detect viruses, detect and remove viruses, change drives, go to full menus, and exit.

The full menu shows the complete directory tree of your hard drive, and a complete list of the files in the current subdirectory. It also provides the ability to immunize your files and make them self-checking, and add new virus signatures to the list used by *Anti-Virus*.

Immunization works by adding a short program to your normal program. When you execute the program, this small does a fast checksum comparison first. Only if the checksums match does the small program allow the regular run. The restrictions on this immunization are that the files larger than 63K, smaller than 14 bytes, files using overlays, files that already have self-test routines, and *Windows* or *OS/2* files are excluded. Immunization can be removed once it has been applied.

As I mentioned, you can add viruses to the *Anti-Virus* list by typing in their signatures or by downloading the list from the Central Point Software BBS.

The manual for *Anti-Virus* is six by seven-inches and has 160 pages, but most of that, ninety pages, is devoted to listing the viruses and what they do. That is interesting reading.

SUMMARY

Considering the proliferation of viruses, some type of protection is required on every hard drive. Both of the products reviewed here work well and efficiently. You can customize them to your needs, and use them in memory or only as frequently as you choose.



PRODUCT SPECIFICATIONS & SUPPLIERS

VirusCure Plus — \$99.95

International Microcomputer Software
1938 Fourth St
San Rafael, CA 94901
(800) 833-4674
(415) 454-7101
(415) 454-8901 fax
(415) 454-2893 BBS

Central Point Anti-Virus — \$129.00

Central Point Software
15220 NW Greenbrier Pkwy, #200
Beaverton, OR 97006
(503) 690-8080
(503) 690-7133 fax
(503) 690-6650 BBS

ULTRASOFT HAS 'EM!!!

WE'VE GOT 'EM ALL!!!

The Hard-to-Find Accessories,
Software and Peripheral Solutions You Need
For Your Laptop, Notebook, and Palmtop!!!

*We Support the Following Models
by Telephone, Fax, or Mail Order:*

Tandy 100/102/200
Tandy WP-2
Tandy 1100 FD/HD
Tandy 1400 LT/FD/HD
Tandy 1500 HD
Tandy 1800 HD
Tandy 2800 HD
Tandy 2810 HD
Tandy 3810 HD
Panasonic CF-150/170/270/370
HP 95LX Palmtop
Atari Palmtop Portfolio
Poqet PC-Computer

We Also Carry:

The Kodak Diconix 150+ Portable Printer
and the Canon BJ-10e Portable Printer

We've got those hard-to-find:

Carrying cases for Laptop & Printer,
and overseas 220V & 240V AC Adapters
In Stock for all you globetrotters, too!!!

WE HAVE THE SOLUTIONS FOR ALL YOUR LAPTOP, NOTEBOOK AND PALMTOP NEEDS!!!

Call, Fax, or Write Today
for a FREE Catalog

Please specify the Make and Model of your Laptop, Notebook, or Palmtop.



1 Transborder Drive, PO Box 247
Champlain, NY 12919
Tel: (514) 487-9293
Fax: (514) 487-9295
9-5 EST Mon-Fri

VISA, MC, and AMEX Orders Accepted!!!
Also, Government & Educational P.O.'s!!!
Quantity Discounts Available!!!
Canadian and Dealer Orders Welcome!!!

Circle 134 on reader service card.

May 1992 PORTABLE 100 19



We still make them!
Options for your
100/102/200!

extRAM:

a 32K byte read/write memory expansion that fits into the option ROM socket inside your "T" —100, 102 or 200. Multi-talented...

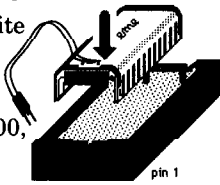

• **RAM-file-bank:** Double your space for .DO, .BA and .CO files. Put them in the extRAM and call them back instantly when you need them. The ever-evolving *EXTRAS* software has great capabilities for enthusiasts, too, to create custom program loaders.

• **ROM-emulator:** No more single-ROM limitation! Swap ROM *images* on command from disk, or from your NODE rampac or datapac, or from RS232. Fast and easy. Works with most ROMware.

Software © 1989 by Paul Globman, © 1990 by Wilson Van Alst, and © 1990 by Tracy Allen.

(Circle 83 on reader service card)

XR4: coming soon, a four-bank, 128k big brother of the above!

(Circle 88 on reader service card)

To Order: Software comes with each extRAM in the form of listings in a 50 pg. manual. Optionally, to save typing, order a disk with all the programs in machine-readable form. We accept Visa/MC, check, M.O. (\$ U.S.) or qualified P. O.

extRAM.....	\$75ea	_____
for? M100 T102 T200		
software disk....	\$15ea	_____
for? tpdd ms-dos Mac		
ROMBO...\$9ea or \$96/12		
BPROM 27C256	\$6ea	_____
subtotal		_____
+ tax (7.25% CA)		_____
+ UPS shipping	3.00	_____
Total.....		_____

Rombo:

our tried and true adapter that allows rom developers and enthusiasts to use stock EPROMs (27C256) in the option ROM socket in the 100/102/200.

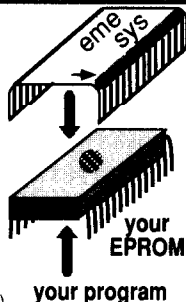

(Circle 81 on reader service card)



eme systems

voice: (510) 848-5725
fax: (510) 848-5748
2229 5th St., Berkeley, CA 94710

HARDWARE REPAIR

your number down on a separate piece of paper. It's possible that the note, posted somewhere over the manager's desk, might jog someone's memory when the package comes back from repair.

Do the same at home, at work, or wherever Radio Shack will be calling you. Tell everyone who might answer the phone that you'll be expecting a call, and that it won't be one of those obnoxious telephone solicitors. (Wait about a week, though, so the information will be fresh in everyone's mind when the call does come.)

THE WAITING GAME

Remember that a store exists to sell, not to be a shipping and receiving depot. Get an estimate on turnaround time for the repair, and then ignore it. After two weeks have gone by, start calling them at least once a week.

Start bugging them regularly. Call. Stop by and reintroduce yourself.

If you're told up front that repairs have been backlogged lately, or that the item will have to go out of state, then do pay attention to that. Wait three weeks if you're feeling generous; then start bugging them regularly. Call. Stop by and reintroduce yourself. Make sure every sales clerk in the place knows that you're looking for a package so they can remind the manager when it comes in. And while you're there, don't forget to get a card for a free battery every month.

If you suspect that something's gone wrong, go into the store and be, umm, PERSISTENT. I know of a former manager who would (allegedly) forget to ship repairs out, or fail to notify customers when the packages returned.

Remember that disk drive I broke? When I handed it over to the store manager, I liked and trusted him but this lessened with each passing week. Finally I demanded that he find out what was up. The drive had gone to two repair centers in two different states, and the

second one told him that it had just been shipped back the day before. It was in my hands a week later.

It's entirely possible that UPS needed five working days to haul a floppy drive 430 miles up Interstate 25 in clear weather. On the other hand, somebody may have been fibbing to somebody else and the manager's phone call might have provided the necessary motivation to get the job finished.

SUCCESS!

One fine day you get the call: Come get your computer! The original repair ticket will be taped to it, but take your copy with you, just in case. You want to check it to make sure that everything that went out came back in.

But don't be surprised if you get back a different board or disk drive, for example. Sometimes your item is beyond repair, or it's cheaper to toss the thing than to invest labor in fixing it. Or the part that needed to be replaced was out of stock, but the assembly that it belonged to was available. Or there was an upgrade that wasn't announced and would only be done when an item came in for repair.

If possible, try out your computer there in the store. Don't be shy about asking sales folks to grab a monitor from another machine or to open a box to loan you a cable or power supply. Even when they have to tear the packaging they can (and do) staple it back together and still sell it as new. If your repaired item's a component—a keyboard, say—attach it to a working computer set up in the store.

EUREKA

If your Model X works, you're golden. Pay for it, smile, and leave. (Don't forget your free battery.) If it doesn't work, grab the manager and demonstrate the problem. By the way, repairs are warranted. So if your broken hardware was out of warranty and you couldn't swap it for a new item before, try asking for a replacement now.

If you can't try your gizmo there, test it as soon as you can and before you add those options back on. If it works, you're done. If not, go back as soon as you can with your receipt and start the process over again.

If you stay organized and persist, you stand a great chance of keeping your Tandy computer running for a long time. No matter if it was born before anyone in the Radio Shack store was—if it does the job for you, it's worth keeping. Enjoy!



COMPATIBILITY: MS-DOS portable with hard disk drives.

Prying Eyes

Your computer doesn't have to be stolen for you to lose important information while traveling.

by Terry Kepner

Do you keep information in your computer that could be harmful if someone unscrupulous were to find it? Information like confidential phone numbers, credit card numbers, passwords to commercial BBS accounts, or your personal or company telephone calling card number? And what about correspondence and spreadsheet files? Would your competition like to have access to that forecast spreadsheet you made for the boss that delineates the business growth plan for the next three years?

Have you ever worried what would happen to your data if someone stole your computer? I know of a Big Five accounting firm in New York City that settled out of court for several million dollars when one of their auditors had his portable stolen while he was on the subway. It contained important financial information that could have crippled the client company if their competitors could have gotten hold of it.

Or, perhaps, are you a writer and don't want *anyone* to see your latest work-in-progress?

If your data is important and you want to protect it from idle hands (you never know if the hotel maid is curious about that portable you left in the room; while she won't jeopardize her job by stealing it, a blank disk and the copy command could give her all kinds of interesting files), you need a program like *FASTLOCK* or *FASTLOCK Plus*.

These two programs form the *FASTLOCK Plus* package from the Rupp Corporation that locks your hard disk, preventing unauthorized access. One, *FASTLOCK*, provides coverage whenever you decide you need it. The other is a permanent watchdog that requires a

password every time you boot your computer.

FASTLOCK and *FASTLOCK Plus* won't protect your files from a truly determined industrial spy, but it will keep them safe from everyone else. They keep the honest people honest, and the curious out of your files.

HOW THEY WORK

FASTLOCK and *FASTLOCK PLUS* operate by copying the important boot sector and boot-up files to a new place on your hard drive and changing the old ones so that they cannot be used to access the hard drive without a password. They do not alter your data or program files, it just makes the hard drive inaccessible to anyone unauthorized to use it.

By changing the boot sector and bootup files, *FASTLOCK* and *FASTLOCK PLUS* makes it almost impossible for anyone to circumvent the protection routine by booting your computer from a floppy disk drive. If you boot from a floppy, the system looks at the boot sector of the hard drive and finds incompatible data. As a result, it thinks there is no hard drive attached.

This method of protection also means that anyone booting from the hard drive cannot get around the program by using any of the interrupt keys (like CTRL C). Every time, *FASTLOCK* comes up first and demands a password. Failing to provide the correct password — you have three tries — causes the program to shut down the computer and record the

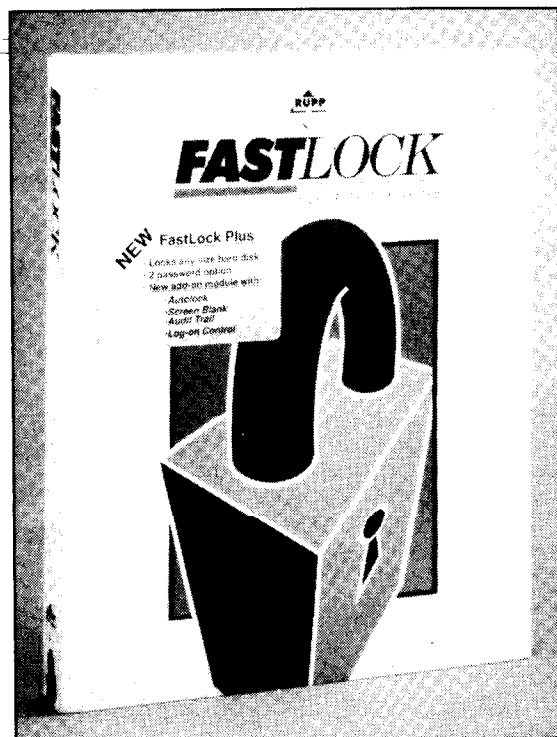

Photo. 1. *FASTLOCK PLUS* protects your hard drive from snoops.

unauthorized attempted access.

FASTLOCK

FASTLOCK is easy to use. Just type *FL* at the DOS prompt when you are ready to turn off your computer. The program comes signs on and asks you for your password, up to six alphabetic characters. After typing it in, the program asks you to do it again to verify that you really typed what you think you typed.

After the second prompt, *FASTLOCK* copies the relevant sections of your hard drive, modifies the old ones, and parks your hard drive heads. Now, turn off the computer. The next time you turn it on, it

will ask for the password before letting the system finish booting up.

After giving it the correct password, **FASTLOCK** restores the sections it changed and lets the system finish booting up. Then it waits for the next time you want it to secure your hard drive.

By making it a part of your shut-down routine (I use **AUTOMENU** with a shut-down option that includes **FASTLOCK** in its .BAT file), you can ensure that your hard drive is always safe from prying eyes. Or, you can save **FASTLOCK** only for those times when you feel you need its protection, leaving it off the rest of the time.

FASTLOCK PLUS

The *Fastlock Plus* module of the package provides constant protection. You do not have to remember to type a special command each time you turn off your computer.

Making the system even more secure are the **SUSPEND** and **XSCREEN** programs. The **SUSPEND** program is a screen-blanking utility that uses password protection to keep others from accessing your computer should you leave the computer unattended, but running. The computer does not record unauthorized access attempts with these two utilities. You may also have problems with other screen blanking software and some misbehaved Window programs.

Another difference is that **FASTLOCK PLUS** creates a special "Emergency Access Diskette" when you install it. Should you forget your password, this disk will provide access to your hard drive. To prevent other **FASTLOCK PLUS** owners from using their EAD's to access your hard drive, each EAD is unique to the computer it was installed on.

There are four other utility programs included with **FASTLOCK PLUS**. The first is a simple password-altering program so that you can change the password without resorting to uninstalling and reinstalling the package on your hard drive.

The second one displays the various versions of the **FASTLOCK PLUS** modules. The third, **WHO**, displays a list of the unsuccessful log-on attempts. You should periodically check this file to see if people have been attacking your computer. The final program is **SCRUB**. This program will securely delete a file. It cannot be unerased by any utility package such as the Norton Utilities or **PCTOOLS**.

PASSWORDS

If you use **FASTLOCK**, or any password program, never pick a password that is obvious to your personality. Most people use all blanks, their birthday or birth month, their spouse or significant other's name, name of a child, or something related to work or play. Choosing any of these makes it child's play for someone else to break into your computer, especially if they know you or your family. For example, I am a science-fiction buff, so choosing anything to do with that subject as a password would be like giving the thief the keys to my house.

Picking a name at random out of the phone book is a good way to get an arbitrary password, so is looking at a map. Just make sure it is a name or sequence of letters that you will remember. And for heaven's sake, don't write the bloody thing down on any books or manuals you take with you!

By the way, should you forget your

**For heaven's sake,
don't write the
bloody thing
down.**

FASTLOCK password, Rupp Corporation has a program that can unlock your computer, but it is available only to registered **FASTLOCK** users, and it takes up to **FOUR DAYS** to do the job. It is a brute force program that tries every conceivable combination of characters until it finds one that works. There is no hidden lock or back door, to prevent others from finding and distributing the secret.

Should you forget your **FASTLOCK PLUS** password, and the Emergency Access Diskette doesn't recover the hard drive, there is no easy way in.

IN SUMMARY

FASTLOCK is a fast and efficient method of protecting your data without going through the trouble of special hardware modifications. It is limited in that it will not lock some hard drives larger than 32 Megabytes (generally, the

CARE plants the most wonderful seeds on earth.

Seeds of self-sufficiency that help starving people become healthy, productive people. And we do it village by village by village. Please help us turn cries for help into the laughter of hope.



File Allocation Table must be smaller than 64K), but partitioned disk drives have more than one FAT so this isn't usually a problem. It also doesn't work on a file server or in a multi-tasking environment (not a likely problem if you're traveling with portable).

FASTLOCK PLUS provides constant security for people whose computers are always accessible to other. It requires MS-DOS 3.0 or greater. In some cases, you might have problems with **FASTLOCK PLUS** and DOS 3.x. The manual suggests upgrading to DOS 4.x or 5.x to correct these problems.

PRODUCT SPECIFICATIONS & SUPPLIERS

FASTLOCK PLUS —\$84.95

Software that locks your hard drive and prevents unauthorized access. Both 5.25- and 3.5-inch disks are included.

Rupp Corporation
P.O. Drawer J
Lenox Hill Station
New York, NY 10021
(212) 517-7775

COMPATIBILITY: Model 100, 102, 200, and Model 100 clones.

Radio Shack Batteries Outlast The Rest

Not surprisingly, Tandy's batteries come out on top.

Downloaded from PCLINK

Every year, there is bound to be at least one battery-powered gift under most Christmas trees. This year was certainly no exception.

Last December 30th, KSTP-TV Channel 5, an ABC-affiliate in St. Paul, Minnesota, offered a timely public service to its viewers. The tests conducted by KSTP-TV were not scientific and they did not endorse any battery brand or brands, but Consumer Correspondent Steve Filmer tested six major battery brands and reported his results, along with tips on selecting batteries for gifts that require them.

Filmer evaluated batteries purchased randomly off retail shelves, including Ray-O-Vac, Duracell, Kodak, Varta, Energizer and Radio Shack. In what KSTP explained was an "unscientific" experiment, battery-powered toys were used to test the longevity of each battery. Radio Shack batteries lasted longer than the other brands tested.

In addition, Filmer's "bang for the buck" test compared the longevity of each battery brand to its price. Radio Shack batteries ranked highest in this evaluation.

Bernard S. Appel, Radio Shack president, said, "These results do not surprise me. In a recent test by a major consumer magazine, Radio Shack batteries were among those receiving the highest rating. According to Appel, there is a good reason why Radio Shack's batteries always test well. "We're 'America's Battery Store'," he said. "Our batteries are top quality, but so are many others. The secret is that we sell more than one hundred million batteries every year. Our stock turns over so quickly, our batteries are always fresh."

"Some brands don't have freshness dates," Filmer said during the program. "Of those we bought that were dated, some were two years old."

Radio Shack stocks 113 different types of standard and rechargeable batteries. "And," concluded Appel, "we can special order any other type if it is still in production. And best of all, those Christmas toys and gifts will run longer on Radio Shack batteries."



The sky's the limit... ...with *Portable 100* magazine.

On the road . . . at home . . . in the office . . . in the air . . . the variety of tasks you can perform with your Tandy Portable is expanding constantly.

To keep fully informed and up-to-date about current trends, new products, and new uses for your laptop, you need *Portable 100* magazine.

From sophisticated input/output (I/O) calls and their applications to simple disk drives, *Portable 100* magazine covers it all.

Portable 100 gives you thorough and timely features, news, columns, and reviews. And they are written in a fast-paced, easy-to-read style, by leading computer experts.

And *Portable 100* gives you all this for just \$19.95, a savings of over 54% off the regular newsstand price! You can save even more money by subscribing for two years for only \$34.95, a savings of almost 60%!

Don't miss a single issue!
Fill out and mail the coupon below,
or to charge it to your credit card, call

1-603-924-9455

***Portable 100*—the magazine for Tandy Notebook, Laptop and Portable Computer users!**



Plus:
More on MS-DOS
Desktop 3
Add 40MB to Your
1400LT
WP-2 Document
Storage
Model 102 Notes for
the New Owner
Decision Making
with your
Portable
Moving up to
MS-DOS

MONEY BACK GUARANTEE!

If you are not completely satisfied with *Portable 100*, you may cancel your subscription and receive a refund on the unmailed issues. Please allow 6-8 weeks for delivery of your first issue.

YES! I want to be more productive with my Tandy portable... and save over 54% off the newsstand price. Send me a year's subscription (monthly except for a combined July / August issue) of *Portable 100* for only \$19.95! Save even more; two years for just \$34.95!

MC Visa Amex Bill me Make checks payable to *Portable 100*
 Check M.O.

Card Number _____ Exp. Date _____

Name _____

Address _____

City _____ State _____ Zip _____

I have a Tandy 100/102 200/600 WP-2 MS-DOS portable

MS-DOS desktop Macintosh Other _____
Mexico & Canada: \$24.95 one year, \$44.95 two years; all other foreign surface: \$49.95 one year, \$74.95 two years; Airmail: \$69.95 one year, \$134.95 two years. All foreign (except Canada & Mexico) U.S. Funds drawn on U.S. Bank.

Mail coupon to: *Portable 100*,
P.O. Box 428, Peterborough, NH 03458-0428

COMPATIBILITY: Model 100, 102, 200, and Model 100 clones.

Tandy 102 Portability Lives!

Adding internal and external NiCd batteries to your portable computer and portable disk drive.

Karl M. Lind

I have read numerous articles on using non-removable batteries in the Model 102. (Hugh Tinling's copy of Dr. Laurence D. Preble's message of August 28, 1983 on the CompuServe Information Service, Jon Kaplan's message on February 14, 1987, and my own Electronics handbooks.) Using these as a start, here is my version of an internal modification to the Tandy 102 that lets you install Nickel-Cadmium batteries in your portable, another project that lets you use an external rechargeable battery pack, and a third project that modifies the Tandy Portable Disk Drive to use NiCd batteries.

But, first, here are a series of warnings on what you are about to attempt:

WARNING: Failure to follow these instructions can be hazardous to your health!

WARNING: If you do not know how to solder, nor know of anyone who does know how to solder, do not do this to your computer.

WARNING: There is a semiconductor device used in this project. Excessive heat (such as a soldering iron) can destroy the device. Only put heat on the device for a maximum of five seconds with a one minute cool down time.

PART I — INTERNAL BATTERIES

Still here? Great! First, here the parts you'll need. All are available from Radio Shack and are relatively inexpensive.

1. One 10 ohm resistor (1/4 watt), RS 271-1303, four for \$.19 (on sale).
2. One 1N914 silicone diode (or equivalent), RS 276-1122 ten for \$.99.
3. Four AA Nickel-Cadmium batteries, RS 23-125, two for \$4.49 (two packs needed).

PROCEDURE

- (a) Install the Ni-Cds in your battery compartment.
- (b) Open the case. (Remove the four Phillips head screws from the bottom and depress the two catches located at the front and rear middle of the machine, and lift off top.)
- (c) Unplug the flat ribbon cable which attaches the LCD screen to the board and CAREFULLY set it somewhere

Why not use a slightly bulkier sealed lead-acid cell to do the same job as the advertised gel-cell battery?

(on a lint-free cloth preferably) where it will not come to harm. Also, unplug the keyboard flat cable and set the keyboard aside. Remove the black fibreboard cover over the printed circuit board and set aside.

- (d) Notice where the plug-in receptacle is soldered in the upper right-hand corner of the printed circuit board (see

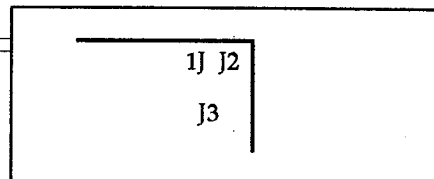

Figure 1. The upper right-hand corner of the Model 102 printed circuit board.

- (e) Identify the cathode end of the diode (the banded end). Twist cathode end of the diode to one end of the 10 ohm resistor. Cut off the excess wire so that 1/2 an inch of twisted wire remains. Cut the other ends of the diode and resistor to a 1/4 inch length.
- (f) Bend the resistor/diode into a jackknife configuration.
- (g) Wrap the diode/resistor package in electrical tape, leaving about an 1/8-inch of the two leads exposed. Solder the resistor lead into J2 and the diode end into J3.

CONGRATULATIONS ON PART I

Now, inspect the joints to make sure that they really are firmly connected and that no metal from the package is touching anything on the printed circuit board.

Re-assemble the unit in the reverse order that you took it apart and reconnect the keyboard and LCD. Put the cover in place and secure with the four screws. Plug the A/C adapter into the computer for a minimum of 14 hours.

And that's it. Your Ni-Cd batteries will power your computer, and every time you use your AC adapter, you will recharge the batteries.

PART II THE EXTERNAL BATTERY PACK

This project is even simpler than the

first one, using external batteries and charging them with the same AC adapter you use with your computer. If you built the internal project, you will have parts left over. You can use two of the parts in this project.

The whole purpose behind this was to have a long range power supply for a lot less than what I saw it for in a catalog. I figured, why not use a slightly bulkier sealed lead-acid cell to do the same job as the advertised gel-cell battery?

The battery used in this project is from a motorized toy manufacturer. Specifically, they are used in electric go-carts and three-wheelers. Their size is 4.25 X 2.75 X 5.5 inches.

Here's the parts list:

1. One six-volt 9.2 Amp-Hour Lead Acid battery. All Electronics Corporation, Part Number GC-695, \$18.00 (15.00 battery+3.00 p+h).
2. One 10 ohm 1/4 watt resistor, RS 271-1301, five for \$.39.
3. One 1N914 silicone diode (or equivalent), RS 276-1122, ten for \$.99.
4. Two Coaxial DC power plugs, 5mm outside diameter, 2.5mm inside diameter, RS 274-1568A, two for \$1.19.
5. One Coaxial Power Jack, 5mm outside diameter, 2.1mm inside diameter, RS 271 1565.
6. Two Female quick disconnect connections, RS 64-3039, ten for \$.99.
7. Electrical tape, wire (zip cord), solder, soldering iron and a steady hand!

Again, except for the battery, all the parts are from Radio Shack.

PROCEDURE

- a. Cut three pieces of zip cord to the length you want. Make sure that two of them are approximately the same length. These are going to be the ones to your computer and disk drive.
- b. Strip and tin all the wires.
- c. Connect and solder the DC power plugs onto two of the cords. Make a note of which wire goes to the center of the plug (tip) and mark it in some way. Connect a large and small female quick disconnect connection on the third cord.
- d. Connect together the other ends of the wires with the small female quick disconnect and the two that are connected to the tip of the power plugs and solder them together. See Figure 2.

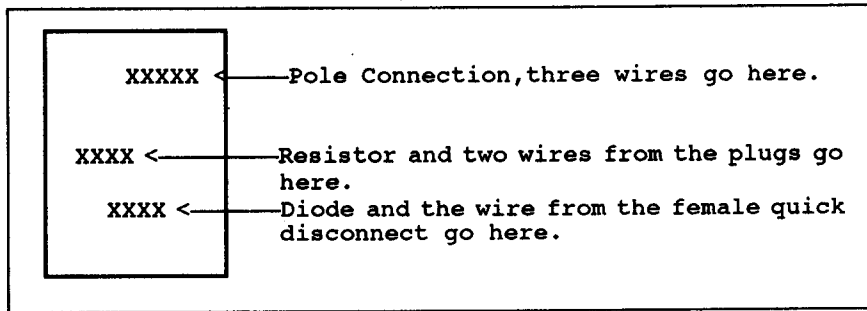

Figure 1. The bottom view of the Model 102 DC power jack.

- e. Solder these three wires to the pole connection on the power jack.
- f. Find the cathode end of the diode (it's the banded end). Twist the cathode end of the diode to the 10 ohm resistor. Cut off the excess wire so you have about an eighth of an inch of twisted wire remains. Carefully solder these two together. Cut the other ends of the diode and resistor to 1/4 inch.
- g. Bend the resistor diode in a jack-knife configuration.
- h. Solder the free end of the resistor to the connection right below the pole position on the Dc power jack and the free end of the diode on the connection below that.
- i. Solder the other end of the wire with the female quick disconnect on it to the connection with the diode on it and the two from the power plugs to the connection with the resistor on it.
- j. Inspect your work to make sure there are no shorts between any connections on the jack or in the plugs.
- k. Wrap the jack in electrical tape and continue down the cords about three inches. That is to provide some strain relief on the jack connections.

AND THAT'S ALL

Congratulations, inspect your connections again (just to make sure), connect the battery to the two female quick disconnects, your computer and/or disk drive and if you wish, you can hook up your AC adapter. The Ac adapter will recharge the battery and run your computer or you can just run it off the battery. Below is the address of the place I got my battery. If you can find one of these for less, GO FOR IT!

PART III THE TANDY PORTABLE DISK DRIVE MODIFICATIONS

The portable disk drives are very similar in power supply construction and thus you can use the exact same parts from the first part of this article. If you installed the modification in your computer, then you can use the left over

parts with this. Two projects for the price of one!

This should work on either the PDD1 or the PDD2. The Ni-Cds will not charge unless the power switch is on. The procedure is basically the same as what you did to your Model 102:

- a. Put head transport plate in.
- b. Remove the four screws from the larger part of the drive and remove the top.
- c. With the front of the drive facing you and upright, remove the two screws from the power section on the left side of the machine. Gently unplug the two-wire cord on the rear of the board and gently swing it to one side.
- d. Construct a resistor/diode unit like in the 102 upgrade. The diode goes to the upper most connection of the DC IN plug and the resistor to the middle connection.
- e. Put everything back together carefully. Put in Ni-Cds and turn the power on the disk drive on. The drive will turn itself off after a half an hour but the batteries will trickle charge in fourteen hours.

That's all there is. Now, your computer and disk drive have rechargeable batteries. You will notice, though, that the battery life between charges is shorter with the internal modifications. This is because the NiCd batteries put out only 1.25 volts per cell instead of 1.5. So, four NiCds give only five volts instead of six, which means less time between charges.

I believe that's a small price to pay for the convenience that the rechargeable batteries provide. Plus, if you build the external power pack, you can keep your NiCds reserved for special situations that require leaving the battery pack at home (or the hotel room).

PRODUCT SUPPLIERS

All Electronics Corp.
P.O. Box 567
Van Nuys, CA 91408

If you have Visa or Mastercard, you can charge it via phone at 1-800-826-5432 (213 and 818 area codes, use 818-904-0524)
No COD's (minimum order \$10.00)

Not a Scuzzy Hard Drive

Add an external hard drive to your Tandy MS-DOS laptop—no modifications!

by Ches Looney

I am not the kind of person who likes to make a gallon of iced tea in a teaspoon. Nothing against teaspoons. I like teaspoons. I need teaspoons to eat my cereal. I use them to taste my stew. I use them to stir sugar even into my iced tea. But when I want to *make* a gallon of tea, I use a better container.

I like my Tandy 1100FD laptop, too. But sometimes I have a gallon of software that I have to fit into my teaspoon-size floppy disk drive, and that makes me unhappy. That is, it *made* me unhappy until I bought an external hard disk from the Tulin Corporation, which funnels gallons of software through the 1100's parallel printer port without the usual hassle.

That forty megabyte hard disk system has proved to be a real delight. It gives me the best of both worlds—a remote workstation and a desktop computer. I can carry the 1100 with a floppy disk or two for relatively small chores and then plug it into the hard disk at home and fire up *dBase IV*, *Quattro Pro*, or any other major software requiring a hard disk. My hard drive is in a 7.1 x 7.1 x 2.2-inch case and connects to the 1100's printer port through an adapter that is about 2 x 4 x 0.5 inches. If necessary, the hard disk can go along on trips, but most of the time it can do the heavy duty computing chores at home.

Tulin offers a large number of hard disk systems for the 1100 computer. Their inventory includes disk capacities from 20 megabytes to 1.05 gigabyte (really!) and sizes from 5.5 x 7.5 x 1.4 inches to 9.9 x 9.6 x 4.3 inches. The one I chose cost \$639 plus shipping and handling. It has a fan and internal power supply and weighs about 6 pounds. Tulin formatted the hard disk with one

partition of about 32 MB and another of about 9 MB. Although DOS 3.3 on the 1100 would permit using the whole 41 MB as a single partition, the sector size would be doubled for partitions larger than 32 MB (according to the fine documentation provided with the system)—good reason for limiting the largest partition to 32 MB.

My pleasure with the system increased substantially when I found that the interface is a SCSI adapter, which

That forty megabyte hard disk system has proved to be a real delight.

uses the printer port as a SCSI connection. For the 1100 and similar computers, this little unit, manufactured by Trantor Systems, opens up enormous possibilities, which include connecting to CD-ROMs and Bernoulli boxes. The adapter comes with a 3.5-inch floppy disk and a 44-page instruction manual that details the software on the disk and provides easy-to-understand instructions for formatting hard disks and for setting up CD-ROMs to use with the interface/computer. I had no need to learn how to use the software, however, because Tulin had already formatted the hard drive.

The information in the book did increase my understanding of how the hard drive is used and what parametric changes are possible.

SETTING UP

The setup procedure could hardly be simpler. Turn on the 1100 and use *SETUP 11* to set up the computer to start from ROM. It should check for *CONFIG.SYS* and *AUTOEXEC.BAT* on the floppy disk and start up in DOS (rather than *DeskMate*). Connect the disk power cable and SCSI cable, plug the adapter into the computer (connections are clearly marked), and connect the SCSI cable to the adapter. Then slip in the Tulin boot disk, power up the hard disk, and reboot the 1100. In a very short time, you'll see that the SCSI interface is connected and you'll learn the size of the disk partitions.

The Tulin boot disk has three files: *COMMAND.COM*, *CONFIG.SYS*, and *TSCSI.SYS*. When you leave the 1100 in the ROM mode, the computer uses the *COMMAND.COM* on the computer's ROM (the "C" drive), so you don't need a *COMMAND.COM*—or the hidden system files—on the floppy disk. Thus, without these files on the floppy, you save space.

The startup procedure loads the *TSCSI.SYS* file into system memory, which takes about 17K. But since the hard disk communicates through the parallel port, DOS doesn't recognize it as a conventional disk; therefore, you can't boot up from this hard disk. For this reason, I added an *AUTOEXEC.BAT* to the boot disk, which sets the path and prompt and then calls *C:DESK* to start *DeskMate*. The result is that I have *DeskMate* up and operating in my 1100 with the hard disk in about the same time for

HARDWARE REVIEW

DeskMate alone with only the floppy drive. The more I use the 1100, the more I am impressed with its design sophistication.

SIZE AND CONVENIENCE

Using the hard disk with the 1100 is convenient. I have created a subdirectory on the D drive for each of my major applications (*Quattro*, *Quattro Pro*, *dBASE III*, *dBASE IV*, *DESK*, *PCTOOLS*, *Personal Tax Preparer*, *DOS*, and a utilities subdirectory, which holds the *Trantor* programs and the *DeskMate* thesaurus. I've installed *Q&A Write* on the E drive since it doesn't seem able to operate in a subdirectory. For the *DeskMate* program, I created an "autoconfig" box for each major program in each subdirectory. Thus, as I change from one subdirectory to another, there is a box on the *DeskMate* desktop for starting up the program.

If this isn't easy enough, you could create *DeskMate* boxes for each of the major programs to avoid the step of changing to its subdirectory. However, I use the autoconfig box so that I have only one *DeskMate* box reserved for the major programs, leaving the other boxes for utilities such as the calendar and address programs.

Now I can compute with ease.

NO MIXUP

Although the bootup procedure for the hard disk is different from regular bootup, I don't run across annoying problems if I get my boot disks mixed up. When the SCSI interface and hard disk are connected, I must have the *TSCSI.SYS* file and the *CONFIG.SYS* file with the line *DEVICE=TSCSI.SYS* on the startup disk. Normally, on the other hand, when I use the 1100 without the hard disk, I use a floppy disk with a short *AUTOEXEC.BAT* file that starts *DeskMate*. But if I use the hard disk boot disk without attaching the SCSI interface, the 1100 pauses and asks for a keystroke to continue the startup process.

In my search for a hard disk system that works from a SCSI port, I found that another company, *MicroSense*, offers a hard drive and parallel port system; however, they hadn't checked its compatibility with the 1100 at the time I

FREE UP MEMORY PUT YOUR PROGRAMS ON A ROM

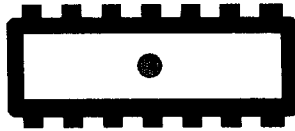

With our tools, you can put your own programs on a ROM. Or we can do it for you. Call For Details On Our Custom Rom Service.

SECRETS OF ROM REVEALED - \$49.95

Concise, easy to understand manual covers everything you need to know to call standard Model 100/102 ROM routines from an Option ROM (listings included), how to call the text editor from .CO and Option ROM programs, the source code for a complete option ROM program that does a search and replace on text files, and information on Model 200 & NEC 8201 ROMS. Includes disk.

C100 - \$699.00

Cross development system for putting 'C' programs on a ROM.

HARDWARE

Eproms. Burners. Molex, EZ-FLEX or socketted Adapters. Erasers.

MODEL 100/102 APPLICATION NOTES

A technical series intended to illustrate some of the capabilities of the Model 100/102 while addressing real problems with real solutions. (Call for list)

NEW

Pro-RBASIC - \$345.00

Professional version of RBASIC (V5.00). Now you can put more than one BASIC program on one Tandy Model 100, 102, or 200 ROM. Improved system enables even larger programs to be put on a ROM. Other enhancements increase the range of convertible code.

**LIMITED OFFER 30%
OFF RBASIC V 4.00
Only \$199.00**

King Computer Services, Inc.

10350 Samoa Avenue, Tujunga, CA 91042 (818) 951-5240, FAX (818) 353-1278

Circle 116 on reader service card

called. Furthermore, their price of \$795 was substantially higher than Tulin's price. *MegaHaus* also has a hard drive and parallel port system, but they understood that Tandy computers had parallel ports that could send data only one way (to the printer) and so were incompatible with their hard drive and parallel port

system.

I would like to commend the Tulin Corporation for offering a line of hard disk drives and SCSI adapter combinations tailored for immediate use with the Tandy 1100FD computer. Now I can kick back, sip my iced tea, and compute with ease.

PRODUCT SPECIFICATIONS & SUPPLIERS

Tulin Model HJLT40B—\$639

Drive

Capacity: 42 megabytes
Data Surfaces: 2
Average Seek Time: 25 msec
Tracks/Surface: 1026
Track Density: 1400 tracks per inch (tpi)
Recording Density: 30,871 bits per inch (bpi)
Interface: SCSI
Data Transfer: About 1.6 MB per second

Manufacturer: Conner
Model: CP 3040
Case includes power supply and fan

Interface

Three connectors: DB25 to 1100FD

printer port, DB25 to printer, DB25 for SCSI cable

Memory requirements: About 17K of system memory

Hardware requirements: Standard parallel port providing bidirectional information transfer and including all ground lines

TERMPower from SCSI device
Properly terminated SCSI device
Operating System: MS/PC-DOS 3.0 or above

BIOS: 100 percent IBM-compatible BIOS

Manufacturer: *Trantor Systems*

Tulin Corporation
2156H O'Toole Avenue
San Jose, CA 95131
(408)432-9025
(408)943-0782 (fax)

COMPATIBILITY: All coimputers.

Dvorak: A Better Keyboard

Changing the face of the Model 100 keyboard.

by Mike Nugent

FACT: An average typist's fingers travel 16 miles per day. FACT: Fifteen of those miles are wasted. Why? Because the keyboard — your keyboard — is an antique. A 19th-century relic!

Designed in the 1870's by Christopher Sholes, the traditional keyboard is deliberately arranged to slow you down so you won't jam the mechanical parts of early typewriters. But that just isn't a problem on your modern computer, is it? For you, those extra miles only mean more work and more typos. Why put up with it?

The Dvorak keyboard is efficient. It eliminates wasted motion so you can type faster with less error and fatigue. That 16-mile hike becomes a one-mile stroll, and your fingers won't mind the walking. Just ask the nation's directory assistance operators, who are among the more than 100,000 Americans already using the Dvorak keyboard. And that number is growing, because Dvorak makes sense.

With that in mind, here's *DVORAK.BA*, to give your Model 100 a Dvorak keyboard. It's easy to use. Just run it once and

It eliminates wasted motion.

swap your keys — that's all there is to it. Then you can remove *DVORAK.BA* from your machine, leaving behind a 281-byte keyboard filter that you can turn on and off at will.

Before we go any further, please remember to back up your important files! *DVORAK.BA* creates a machine language file, and mistakes here could boot your computer right back to the turn of the century, when your keyboard was only 30 years old. While you're at it, save *DVORAK.BA* to cassette or disk.

Run *DVORAK.BA*. It installs the keyboard filter just below *HIMEM* and then adjusts *HIMEM* to protect the filter and anything in memory above it. Next, turn off the computer and swap the keys, using your official "Dvorak Keyboard Reconfiguration Tool." Mine looks remarkably like a paper clip that has been first straightened and then bent into a U-shape, with little quarter-inch hooks added to the free ends.

Lower the tool over a key and work the hooks up under it. (Mine works best when grabbing a key diagonally from opposite corners.) Gently lift the key, rocking it back and forth until it pops off. Remove all the letters and punctuation keys except

```

10 CLS: PRINT "DVORAK.BA Keyboard Filter Program"
20 PRINT "Copyright 1986 by M.J. Nugent, Jr."
30 PRINT @120, "Installing Dvorak filter ..."
40 '— init —
50 READ SIZE: NH = HIMEM-SIZE
60 CLEAR 256,NH: DEFINT I, J
70 READ SIZE, HOOK, BLKS, RX
80 DIM RP(RX), RO(RX)
99 '— load m/l code —
100 DST = HIMEM
110 FOR I=1 TO BLKS
120   READ TYPE
130   ON TYPE GOSUB 500, 600
140   DST = DST+LN
150 NEXT
199 '— relocate —
200 ENTRY = HIMEM
210 FOR I=0 TO RX: READ RP(I): NEXT
220 FOR I=0 TO RX: READ RO(I): NEXT
230 FOR I=0 TO RX
240   LCN = ENTRY+RP(I)+1
250   FX = ENTRY+RO(I)
260   B = INT(FX/256): A = FX-B*256
270   POKE LCN,A: POKE LCN+1,B
280 NEXT
299 '— stuff vector —
300 POKE HOOK,201
310 B = INT(ENTRY/256):A = ENTRY-B*256
320 POKE HOOK+1,A: POKE HOOK+2,B
399 '— beep 'n' boogie —
400 BEEP
410 PRINT @120, "Dvorak filter installed at";HIMEM
420 KEY6,"POKE62975,195"+CHR$(13)
430 END
499 '— subroutines —
500 READ LN
510 FOR J=0 TO LN-1
520   READ BYTE
530   POKE DST+J,BYTE
540 NEXT
550 RETURN
599 '
600 READ LN, SRC

```

Continued on page 32.

Listing 1. This program creates a machine-language program that remaps the keyboard from QWERTY to DVORAK.

the *A*, *M* and *←* keys. Those three keys won't change, nor will the numbers and special keys (*ESC*, *TAB*, *CTRL*, etc.).

To place the keys into the Dvorak arrangement, press each key gently, but firmly, onto its respective switch. When you've finished, turn on the machine. Go to *BASIC*, press *F6* — and *voila*, you have a Dvorak keyboard. Welcome to the future. It'll take some adjustment, but you'll find it worth the effort.

For starters, you can type more than 3,000 common English words directly on the home row, as opposed to a mere 100 on the old keyboard. That's because Dvorak's home row contains the letters used in 70 percent of your typing. Your stronger right hand now handles 56 percent of the load, whereas the weaker left hand previously did most of the work.

Dvorak favors the first two fingers of each hand, which are typically stronger. And the hands move *up* for punctuation, which is easier than moving down. Learning to type on the Dvorak keyboard is easier than on the Sholes. You

Beware of programs that CLEAR xxx, MAXRAM

"hunt-and-peck" typers have the advantage here. The rest of us must unlearn some old moves. Typically, a 40 word per minute typist becomes equally proficient on Dvorak in about 40 hours, roughly one hour for each wpm of present speed. After that, you won't want to go back.

Your new Dvorak keyboard conforms to the ANSI x4.22-1983 standard with only two minor exceptions. First, the rectangular brackets are reversed, your right bracket being the shifted one. Second, ANSI calls for the 'cents' symbol above the number six. Your keyboard had the caret there, which you'll need for many uses peculiar to the Model 100. To generate a 'cent' symbol, press *Grph 6*, just as you did on your old keyboard.

Since the key caps have been moved, breaking up the Model 100's embedded numeric keypad, this version of Dvorak simply disables the *NUM* key. It has no

effect now. The Dvorak filter stays in high memory. You can toggle the filter on and off with this one-line *BASIC* program. Save it as *TOGGLE.BA*.

```
10 POKE 62975,PEEK(62975) XOR 10:MENU
```

When you want to toggle from the Dvorak configuration to Sholes or vice versa, simply select *TOGGLE.BA* at the Model 100 main *MENU* and press *Enter*. When the *MENU* returns, the alternate keyboard configuration is active.

Note: The Dvorak filter must remain protected by the *HIMEM* pointer. Beware of programs that *CLEAR*

xxx,MAXRAM or some value above *HIMEM*. They can overwrite the filter and cause a cold start. One solution is to modify the offending programs to respect *HIMEM*, for example, *CLEAR xxx,HIMEM* (or *HIMEM-xxxx*)

GET THE ADDRESS RIGHT

Attention, Tandy Portable Disk Drive users. *FLOPPY.CO* must load at a specific address, so you must ensure that *DVORAK.BA* installs the filter below *FLOPPY*'s load address. Here's how. In line 10 of *DISKGO.BA*, *FLOPPY*'s load address is the *xxxxx* in the *CLEAR*

BUILDING QUALITY CASES SINCE 1952

A.T.A. heavy-duty shipping to lightweight carrying cases

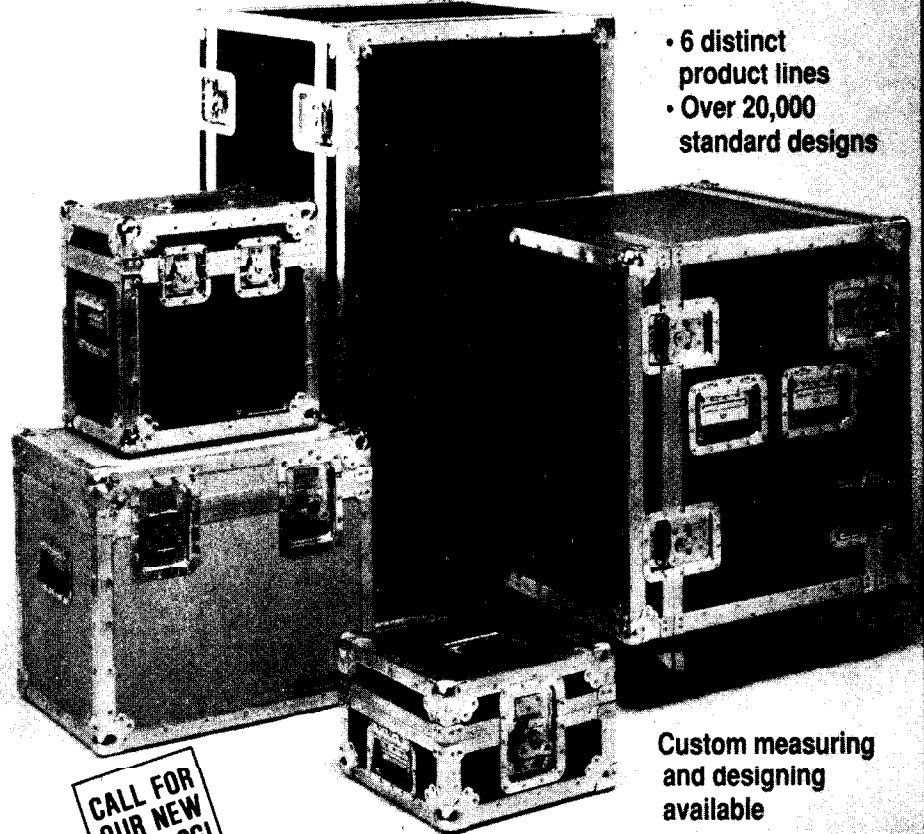

- 6 distinct product lines
- Over 20,000 standard designs

Custom measuring and designing available

CALL FOR OUR NEW CATALOG!

Call Today For More Information

ANVIL CASES
SUBSIDIARY OF ZERO CORPORATION

15650 Salt Lake Ave., City of Industry, CA 91745 • P.O. Box 1202, La Puente, CA 91744
(800) FLY-ANVIL (800) 359-2684



BARCODE PRODUCTS

For LAPTOPS, PC's & TERMINALS

● BARCODE ROM FOR TANDY 100 and 102

Scans, Prints, File Manager, Utilities, Calculator, and more. Six scanning-applications—built in. Use it as an extension of your desktop PC system for FAST, easy portable data-collection, database, and other tasks.

● BARCODE SCANNERS FOR TANDY, NEC, AND MOST OTHER LAPTOPS

From low cost, low power, hand-held LED pistol-grip types, rugged stainless-steel wands, I-R Lasers, and CCD readers, to the latest moving-beam Laser-diode scanners. We can interface them all!

● BARCODE SCANNERS & INTERFACES FOR PC's, AND TERMINALS

Hand-held and fixed-mount types, with either internal or external decoder and interface. Lets you connect straight from the scanner to the PC, terminal, P-O-S terminal, or smart cash register, via RS-232C, OCIA, PC keyboard wedge, wand-emulation, and others.

● BARCODE PRINT-GENERATORS

For EPSON, TANDY, H-P LASERJET, and true compatibles. Supports all major Barcode types.

For more information, please contact:

OPTICAL DATA SYSTEMS Inc.
P.O. Box 1987, Escondido, CA 92025
Tel: (619) 745-6563 Pacific Time

Circle 190 on reader service card.

256,xxxxx statement. Before running DVORAK.BA, type that CLEAR statement to preset the HIMEM pointer, and then run DVORAK.BA. Finally, modify line 10 of DISKGO.BA as follows:
10 IF HIMEM <xxxxx THEN CLEAR 256, HIMEM ELSE CLEAR 256,xxxxx

Thereafter, should anything exist in protected memory below FLOPPY's load address, DISKGO will simply load FLOPPY without changing the HIMEM pointer. For users of multiple RAM banks, it's essential that the Dvorak filters reside at the same address in each bank. So before starting, be sure that HIMEM is the same value in all banks. Then run DVORAK.BA in each bank (first making the FLOPPY.CO fix, if that applies to you). But don't swap the keys or press F6 yet. When all banks are done, power down, swap the keys and power up. Now, in each bank go to BASIC and press F6, enabling Dvorak in that bank.

DVORAK.BA serves as an introduction to the Dvorak keyboards. It gets you up and running but is vulnerable to interference from other programs. For more serious applications, I'm making available a tape with several versions of DVORAK for various hardware/software combinations, including a functional numeric keypad. For a copy, mail \$24.95 (check or money order) to Tri-Mike Network East, P. O. Box 372, Peterborough, NH 03458. A similar package for the Tandy 200 is in the works and should be available as well.

As for you switch hitters, how would you like to have both the Dvorak and Sholes characters on one set of keys?

I'm looking into it. To learn more about Dvorak, contact the Dvorak International Federation at 11 Pearl Street, Brandon, VT 05773. Telephone (802) 247-6020. They can supply information on where to get training materials, keyboard conversion software for other computers and just about anything else relating to Dvorak. Federation president Virginia Russell was most gracious and helpful to me in my research for this article. Yes, Virginia, there is a Model 100 Dvorak program!

```

610 FOR J=0 TO LN-1
620   POKE DST+J, PEEK(SRC+J)
630 NEXT
640 RETURN
699 '— data (obviously!) —
700 DATA 281, 62975, 9, 14
710 DATA 1, 2, 227, 225
720 DATA 2, 121, 6965
730 DATA 1, 9, 205, 92, 118, 33
735 DATA 132, 0, 195, 151, 115
740 DATA 2, 21, 28757
750 DATA 1, 2, 230, 239
760 DATA 2, 37, 28778
770 DATA 1, 3, 196, 208, 0
780 DATA 2, 10, 28818
790 DATA 1, 76, 195, 156, 112, 205
800 DATA 197, 112, 58, 165, 255, 183
810 DATA 200, 58, 166, 255, 254, 43
820 DATA 208, 229, 213, 33, 238, 0
830 DATA 22, 0, 95, 25, 126, 50
840 DATA 166, 255, 209, 225, 201
850 DATA 27, 16, 14, 15, 1, 4, 6, 5
860 DATA 8, 24, 18, 22, 23, 10, 13, 20
870 DATA 28, 29, 30, 25, 21, 11, 12, 2
880 DATA 19, 7, 31, 9, 42, 17, 3, 0
890 DATA 32, 33, 34, 35, 36, 37, 38, 39
900 DATA 40, 41, 26
910 DATA 14, 21, 40, 44, 65, 71, 75, 97
920 DATA 107, 116, 126, 187, 192, 202, 2
24
930 DATA 123, 50, 50, 50, 85, 63, 89, 12
0
940 DATA 120, 120, 132, 195, 208, 177, 2
38

```

End of listing.

DEFUSR appears monthly to answer your questions about Tandy notebook computers.

Send your queries to: DEFUSR, PORTABLE 100,
P.O. Box 428, Peterborough, NH 03458-0428.
Please enclose a stamped, self-addressed envelope for our reply.

EXTERNAL RAM FOR MODEL 100?

Do you know of any company which sells a 32K RAM external cartridge designed for the Model 100? I know about the larger models (128K and up), but I neither need — nor want to pay for — that much memory.

Alternatively, does anyone sell a Model 100 adapter for NODE's 32K RAMPAC cartridge, which is apparently made only for the Model 102?

**John Vinokur
Champlain, NY**

Sorry, John, but Node is the only vendor currently supplying external RAM for the Model T line. Does anyone else have a suggestion for John. -tk

TANDY 600

I bought during Radio Shack's all-out closing sale of the Tandy 600, one of those handy laptops.

After one month, a certain section of the display started to flicker and finally a few days after that, the whole screen gave out completely. The reason for this malfunction were two or three broken strands in the cable ribbon leading to the display screen.

Looking at that cable (it is visible with the screen open and closed at the left pivot point of the display) and at the sharp bend it is forced to make each time the computer is closed, it is hard to imagine how this could not have occurred. I am especially worried about this happening again. Do you know of this problem existing in other Tandy 600's? If you do, is there a remedy to fix this defect?

I would appreciate some information on this subject and on whether or not the program chips can be rearranged on the board so that the spreadsheet PLAN (my most frequently used application) and its files are in first position on the display.

I have another question, concerning the swapping of disks. Why is there a warning against changing disks without the computer being in the System Man-

ager or without it being turned on?

**Jens D. Sandberger
Urbana, IL**

Yours is the first complaint I have heard regarding the screen cable breaking. I don't believe it is a common occurrence.

PLAN is a permanent fixture in ROM, and so is its position in the MENU. Every time you cold-start your computer, PLAN will pop up in its normal position. But, you can move it in the directory by finding its eleven-byte location (by PEEKing) and then using the POKE command to punch it to another location. To make it first, you would have to copy the BASIC entry to PLAN's position, and PLAN to BASIC's position (copying their code to paper first so you don't make any mistakes).

You can't remove the preset Menu choices.

You cannot eliminate any of the preset Menu choices. They will always be there, but you can make them invisible by using POKE to put a zero in the first position of the eleven-byte entry. -tk

"FLOPPY.CO" — A MAXRAM CONFLICT?

Bruce Brown's problem with "Lost FLOPPY.CO", reported in March 1992 DEFUSR, may be a MAXRAM conflict. UltraSoft's Disk Power 100/102 uses the Alternate Screen Buffer / TELCOM area above MAXRAM and also one byte at

MAXRAM. Thus utilities like Paul Globman's RUN.BA (Nov 1990) may need modification to work with Disk Power.

An address table clarifies this, see figure 1.

WEETAX programs include CLEAR string space, MAXRAM-3 to preserve the MAXRAM byte so Disk Power will survive switching the Model 100 off and back on.

**Thomas M. Olsen
Phoenix, AZ**

BY THE LIGHT OF THE MOON...

A friend of mine passed on several copies of Portable 100. I entered several of the programs into my Model 200. I was very pleased to see that they all worked 100 percent except the moon tracking program (Jan 88, p. 21).

The moon tracking program runs fine on my Model 200 except for the graph chart. I compared the azimuth and altitude bearings for my location with actual moon bearings and found them to be correct.

I seem to have a problem with lines 470 and 480 where the program fills in the graph box for night / day.

Can anyone help me with lines 470 and 480? Is there an error in formula?

**Dan Babin
Sherman, TX**

You're the first to mention a possible bug in that program, and unfortunately you don't provide us enough information to see the problem. Dan, you'll have to be a bit more specific before we can help you. What is going wrong? -tk

RAM Address	Use
MAXRAM = HIMEM+3	DiskPower byte
MAXRAM-1 = HIMEM+2	WEETAX file prefix
MAXRAM-2 = HIMEM+1	WEETAX music on/off
MAXRAM-3 = HIMEM	top of BASIC area

Figure 1. WEETAX needs two global variables for interprogram communication:

TravelPaq Offers Convenience and Efficiency For Business Travelers

Notebook computers are making the portable office a reality. The average business traveler often needs to carry a garment bag, briefcase, computer, peripherals, telephone and more. The industry has evolved to the point where portability isn't enough anymore. The consumer is now demanding convenience and efficiency as well.

With this in mind, LapPac has developed *TravelPac*, a two-sided, expandable briefcase that enables the business traveler to carry a notebook computer, necessary accessories, and complete office supplies in the same lightweight briefcase. The *TravelPac*, is designed with one side to accommodate the LapPac computer family, as well as other notebook computers and offers safe and roomy storage capabilities for an AC adaptor, spare batteries, power cord, printer cables

and a portable printer.

TravelPac has also put the convenience of an office at your fingertips. The intelligently designed space contains two pocket file folders, floppy disk storage, pen and pencil sleeves, business card/credit card compartment, Velcro™ sealed privacy pocket and multi-function small and medium size pockets.

LapPac executives have traveled around the world with portable computers and know what the problems of a business traveler are; that's why LapPac has designed all of its notebook computers and accessories to be not only portable but convenient.

Suggested retail price \$129.00. For further information, contact LapPac Computer Corporation, Austin, Texas, 1-800-388-5541. Or circle 62 on the reader service card.

U.S. Robotics Enhances WorldPort Product Lines With Fax

U.S. Robotics has announced the addition of new fax/data modems to its WorldPort line. The first of these products to ship will be the *WorldPort Palmtop Fax/Data* modem.

The new WorldPort fax products are designed for ease of use. The included fax software is intuitive and user-friendly, even for complex operations such as sending broadcast, or group faxes, performing background operations, and sending delayed faxes with a specific date and time for transmission.

What sets these fax modems apart from others is that they include U.S. Robotics-designed software, providing complete compatibility and allowing them to function seamlessly as integrated products.

The WorldPort portable product line currently includes eight products, three of which have fax capabilities. The WorldPort products, widely known as the most complete portable modems, include features such as dual phone jacks, LEDs, speakers and an acoustic interface.

The WorldPort brand, which includes the world's first portable

V.32 modem, now scores another coup with the fully-featured *WorldPort 9696*, the first portable modem to combine V.32/9600 bps data capability with send-and-receive Group III fax capability and MNP 2-5 error control and data compression. The *WorldPort 9696* features 9600 bps CCITT V.32 data transmission, and with MNP 5, has a maximum effective throughput of 19,200 bps. It includes *WorldPort Fax Software*, and will ship May 31 for a list price of \$699.

All WorldPort fax/data modems with *WorldPort Fax Software* include delayed send capabilities, allowing users to prepare documents in advance, specifying a time and date for transmission. WorldPort fax modem users can also send and receive faxes in the background while working in other applications, and can send group faxes, which allow the sending of multiple faxes simultaneously.

For more information, contact U.S. Robotics, 8100 North McCormick Blvd, Skokie, IL 60076, (800) DIAL USR. Or circle 64 on the reader service card.

New Laser-Quality Portable Computer Printer From Brother

The Consumer Products Division of Brother International Corporation has introduced their new portable HJ-100i Ink Jet computer printer.

The first thing you notice about the HJ-100i is the quality of its performance. At 360 dpi, the resolution is perfect. An easy-to-use front panel allows you to select features such as quality mode and type size at the touch of a button.

The HJ-100i also offers users complete portability and choice of operation either with an included AC adapter or an optional Ni-Cad battery pack. Laptop or notebook users will love the lightweight (4 lb.), com-

pact (12-1/4" w x 8-1/2" d x 1-7/8" h) HJ-100i and its ability to perform graphics, text, spreadsheet or any combination of functions, anywhere, anytime.

Brother's new HJ-100i allows you to pack some of your company's letterhead, envelopes and even transparencies when you go on the road. It prints on a variety of paper. While printing, the print-head moves along at 83 cpi in high quality mode. And it won't slow down when printing in bold or various type sizes.

The new Brother HJ-100i is compatible with virtually all PC's. An optional cut sheet feeder is available for users who need multiple copies (up to 30 pages) of printed documents. The new Brother HJ-100i is expected to retail for under \$399.00.

Nancy Long, Brother International Corporation, 200 Cottontail Lane, Vantage Court, Somerset, NJ 08875-6714; (908) 356-8880; FAX (908) 469-7636. Or circle 68 on the reader service card.

SemWare's QEdit Named "Best Program Editor"

QEdit has received the 1991 Readers Choice Award for "Best Program Editor" from the readers of *Data Based Advisor* magazine.

The most commonly cited reasons for QEdit's popularity are its compact program size, fast operation and ease of use. Only the Q.EXE file is required to run QEdit. This file occupies less than 45K of disk space. Pull-down menus and the ability to customize many aspects of QEdit make it very easy to use.

QEdit is an excellent tool for writing program code, entering ASCII text, managing electronic mail, and creating letters and documents. While it requires less than 64K memory to operate, it allows editing of files as large as available DOS memory.

QEdit is available in three versions: QEdit Advanced, the standard DOS version; QEdit TSR, a memory-resident version that will pop-up over other DOS applications; and QEdit for OS/2.

For more information, contact Wendell Newsome, SemWare, 4343 Shallowford Road #C3A, Marietta, GA 30062-5022; (404)641-9002; FAX (404)640-6213. Or circle 66 on the reader service card.

STATPOWER INTRODUCES AUTO ADAPTER FOR NOTEBOOK COMPUTERS

Statpower Technologies Corp. introduces the NOTEpower universal automobile adapter for notebook computers. NOTEpower recharges and operates any notebook computer by converting power from the vehicle's cigarette lighter socket. NOTEpower is an ac outlet in the car, allowing operation of battery chargers and ac adapters for cellular phones, camcorders, power tools and other rechargeable equipment. Simple to use — just plug the ac adapter/charger unit supplied with the notebook computer into the ac receptacle on the NOTEpower.

NOTEpower is a true dc to ac inverter that converts 12V dc power into 115V ac power producing up to 50 watts of power. NOTEpower operates from any 12V battery source.

Lucid 3-D Announces New Graphing Package

Lucid Corporation has released version 2.5 of *Lucid 3-D*, its three-dimensional spreadsheet. Choose from 15 different graph styles, with rotation, switching and grid control, giving you a total of 53 different ways to view your data. This new release also enables you to perform a universal search for alpha or numeric strings in spreadsheets and notepads.

Lucid 3-D includes the following features:

- * Memory-resident. It pops up over other programs. Just hit the hot key and pop up your spreadsheet.
- * Three-dimensional. Every cell can contain another fully-functional spreadsheet. As many levels as your hard disk can hold!
- * Fully noteable. No optional code required. Just press one key, and attach a note up to 8K to any cell.
- * Macro power. Lucid provides special EDMAC and COMPMAC codes that let you compose and playback macros

of any length and complexity.

- * Multiple windows. Put up to nine windows on the screen at once.
- * Completely mouseable. Mousing is built in — not just “added on.” Use the keypad, short-cut keys or the mouse — which feels most comfortable to you.
- * Context-sensitive help.
- * Clipboard with copy, move, cut, paste, grab and dump abilities.
- * Auditing features built-in.
- * Universal search capability.
- * Pop-up calculator.

Don't have a hard disk? You can run *Lucid 3-D* from a single floppy — with room left over to store your data. Thanks to Disk+'s CONVERSION feature, *Lucid 3-D* will work with Models 100/102/200.

Lucid 3-D retails for \$59.95. For more information, contact Lucid Corporation, 101 W. Renner Road, Dallas, TX 75082—2017, (800) 967-5550, (214) 994—8100. FAX (214) 994—8103. Or circle 65 on reader service card.



Photo 1. the Statpower DC to AC inverter lets you run your laptop computer from a standard cigarette lighter socket.

For all those people who are running up against the battery life limitations of their portable equipment — NOTEpower offers a convenient universal solution.

Suggested retail price for NOTEpower is \$79.95. For more

information contact: Maria Chalkas, Statpower Technologies Corp., 7725 Loughnead Hwy., Burraby, British Columbia V5A 4V8, (604)420—1585, fax (604)420—1591. Or circle 63 On the reader service card.

NEW VERSIONS OF SUPER PC-KWIK AND PC-KWIK POWER PAK PROVIDE DUAL LENDING AND SUPPORT FOR VCPI MEMORY SPECIFICATION

Multisoft Corporation announced that it is now shipping new versions of its disk cache, *Super PC-Kwik*, and its integrated package of performance enhancement utilities, *PC-Kwik Power Pak*. Version 4.13 of *Super PC-Kwik* automatically lends either expanded or extended memory to applications, supports popular applications which use the VCPI memory specification, and is fully compatible with additional software applications such as *Stacker* and *RBase*. Version 2.13 of *Power Pak*, which contains *Super PC-Kwik*, includes all of these capabilities as well.

Software applications usually require either extended memory or expanded memory to function properly. Starting with version 4.0 of *Super PC-Kwik* and 2.0 of *Power Pak*, the PC-Kwik family has automatically loaned the type of memory it was using when an application needed it. Users who work entirely in Windows don't need the ability to lend different types of memory, since Windows uses only extended memory. However, many users switch back and forth between Windows and DOS, or work with DOS applications that sometimes require a different type of memory from what the cache wa using.

The dual lending feature in the new versions provides the optimum solution, since users now only need

a single cache setup. The cache will lend either extended or expanded memory as needed by the application. For this feature to be effective, users must have a memory manager such as 386MAX version 6.0 and later, DR DOS version 6.0 and later, or QEMM version 5.1 and later, which allocates memory from a common pool.

Special memory-lending support is also provided for applications such as Autodesk's AutoCAD, Dorland's Paradox, and Lotus 1-2-3, which use the VCPI memory specification. *Super PC-Kwik* automatically uses all of the available RAM for disk caching, then lends memory to application programs as they need it. This allows each application to run with its complete memory requirements met, while retaining an optimum cache size to ensure maximum performance of the application.

Additional compatibility features have been added to increase the default amount of memory loaned to Windows, automatically detect *Stacker* disk compression software for seamless operation, and improve operation with the *RBase* database program.

For more information, contact: Multisoft, 15100 SW Koll Parkway, Beaverton, OR 97006, (800) 759-5945 or (503) 644-5644. Or circle 67 on the reader service card.

New Info Select Version 2.0

The award winning "Tornado" is now even better - once again! With INFO SELECT 2.0 you get all these important new features:

- * Window sorting - sort windows by string, date, or number
- * Neuron searching - search the way your brain works!
- * Search result highlight - now the words you find are fully highlighted!
- * Instant envelopes and shipping labels - automatically finds addresses!

- * Work/home merging - finds and removes duplicate windows
- * New modern look - shadow windows, improved colors, improved style.
- * And much more ...

For more information, contact MicroLogic, P.O. Box 70, Hackensack, NJ 07602, (201) 342-6518, fax (201) 342-0370. Or circle 69 on reader service card.

COMPATIBILITY: Model 100, 102, 200.

FIREBALL.100

A fast-paced and fun little program for your Model T.

by Thomas H. Jones, Jr.

Settle back and enjoy this arcade-style game in the tradition of some of the greats! Now you and your trusty Model T can take on the evil marauders from who knows where. Challenge the computer or your friends for hours of fun-filled adventure with *FIREBALL.100!*

The rules are simple. Make your way through skill levels by shooting down the bad guys and adapting yourself to situations as they arise.

Here are the key commands and their function:

- (a)rm -arms your weapons
- (f)irc -firs your weapons
- (,) -move left
- (.) -move right
- (1) -select top row of field of fire
- (2) -select middle row of field of fire
- (3) -select bottom row of field of fire
- (p)ause -pause the game, any key to continue
- (q)uit -end game

To fire your weapons, make sure you arm and select the range before you fire. Default for range is 1 (top row).

Make sure the CAPS lock key is released (off).

Take note of the convention with *PRINT USING* where |7| indicates 7 spaces between backslashes.

```

0 REM FIRE*.BA by Thomas H. Jones
1 CLS:CALL16959
5 DEFINT A-M:DEFSTR V-Z
20 B=1:D=0:E=1
30 F=1:G=F+1:H=0
40 L=60:W=SPACE$(15):X=W
50 LINE (2,2)-(237,61),1,B
60 GOSUB 300
100 REM *** Plot target
105 A=41:FOR I=1 TO 3:FOR J=1 TO 15
110 IF V<>TIME$ THEN V=TIME$:L=L-1:PRINT@40
*6+24,USING"count #.## ":(L\60)/10
0+(L\60):PRINT@64,"Fireball*Lvl",B:IF L<=
0 THEN GOSUB 700
115 C=A:A=40*I+J
120 PRINT@C,CHR$(95):PRINT@A,"X"
125 PRINT@144,USING"score:#####",H
130 V=INKEY$:IF V="" THEN 145
135 C=INSTR("af,.123pq",Y)
140 ON C GOSUB 200,200,300,300,400,400,400,
700,700
145 IF (J-F) AND (Y<>"f") THEN GOSUB 600
150 GOSUB 500:NEXT:IF (B=2) OR (B=4) THEN Z=W
155 W=X:PRINT@161,Z:PRINT@201,W:NEXT:PRI
NT@A,CHR$(95)
160 GOTO 100
200 REM *** arm & fire routines
210 IF Y="a" THEN D=1:Y="Range 1:2:3":SO
UND 1000,1:GOTO 280
220 IF Y<>"f" OR D<>1 THEN 280

```

```

230 Y="*Fire* ":D=0:PRINT@40*E+16,CHR$(3
2)
240 IF MID$(W,F,1)="" OR MID$(Z,F,1)=""
THEN Y=Y+"Barrier!":H=H-50:SOUND 13000,2:
GOTO 280
250 FOR K=2421 TO 3121 STEP 300:SOUNDK,1
:LINE(F*6+2,45)-(F*6+2,8*E+4):NEXT
260 LINE(F*6+2,45)-(F*6+2,8*E+4),0
270 IF J=F THEN Y=Y+"Hit!":H=H+100:PRINT@4
0*I+J,CHR$(255) ELSE Y=Y+"Miss!":H=H-50:GO
TO 280
280 PRINT@104,USING "\ " \";Y
290 RETURN
300 REM *** left right movement***
310 IF C=3 THEN G=F:F=F-1
320 IF C=4 THEN G=F:F=F+1
330 IF F<=0 THEN F=15
340 IF F>=16 THEN F=1
350 PRINT@40*6+F,CHR$(133):PRINT@40*6+G,
CHR$(32)
360 RETURN
400 REM *** range calculation ***
410 PRINT@40*E+16," "
420 IF D=1 THEN E=VAL(Y):PRINT@40*E+16,C
HR$(155)
430 RETURN
500 REM *** Barrier
510 IF B=5 THEN W=SPACE$(15):Z=W:RETURN
520 M=INT(RND(1)*(15+1))
530 IF M<10 THEN MID$(X,J,1)="" ELSE MI
D$(X,J,1)=""
540 RETURN
600 REM *** enemy hit
610 IF (C=2) OR MID$(W,J,1)="" OR MID$(Z,
J,1)="" OR B<=2 THEN RETURN
620 FORK=3121 TO 2421 STEP -300:SOUNDK,1:LIN
E(J*6+2,8*I+4)-(J*6+2,45):NEXT
630 LINE(J*6+2,8*I+4)-(J*6+2,45),0
640 H=H-(25*(B-2))
650 Y="Your Hit!"
660 PRINT@104,USING "\ " \";Y
670 RETURN
700 REM *** game over/pause
710 IF C=8 THEN PRINT@264,"pause" ELSE 7
30
720 V=INKEY$:IF V="" THEN 720 ELSE RETURN
730 B=B+1:IF B>SQR<((B-1)*1000) THEN PRINT
@224,"GameOver" ELSE L=60:RETURN
740 IF H>4999 THEN H=4999
750 A=(H*15)/5000:FOR B=0 TO A:READ V:NE
XT
760 PRINT@64,USING"Rank:\ " \";V$
770 PRINT@264,"Replay(y/n)"
780 V=INKEY$:IF V="" THEN 780
790 IF V="y" THEN RUN
800 IF V="n" THEN MENU ET SR 780
810 DATA worm,slug,amateur,beginner,begin
ner,beginner,pilot,pilot,pilot
820 DATA ace,ace,ace,captain,commander,m
aster

```

Listing 1. FIREBALL.BA. Take on evil marauders in this arcade-style game on your Model 100.

COMPATIBILITY: Model 100/102 (one column), MS-DOS Deskmate (the other).

Tips & Hints

Important information for Model T Weetax users, and for MS-DOS Deskmate users.

DeskMate Hints

DeskMate software users sometimes get "out of memory" error messages when performing certain functions. It happens, for example, when using *Draw*. When it does, check to see if the Autoproof or Alarm functions are active. Both are memory-resident programs that use memory another function may need.

If you get this error, try turning off both Autoproof and Alarm, temporarily, and see if it goes away.

A customer wrote (March 1992) about his mouse. It worked fine when he was in *DeskMate*, but disappeared when he went to a non-*DeskMate* program. *DeskMate* has its own mouse driver, but it only works with *DeskMate*. If you want to use your mouse with other programs,

you need to install the MS-DOS mouse driver. Add this line to your CONFIG.SYS file:

DEVICE=C:\DOS\MOUSE.SYS

If DOS is in another directory, of course, change the path (after the equal sign) to the actual path to your DOS files. You can edit CONFIG.SYS with either your *DeskMate* TEXT program, or the MS-DOS EDIT function.

by Ed Juge
Tandy Corporation/Radio Shack
courtesy of the
Tandy User Group Newsletter



DISK POWER PROBLEM

DA customer using WEETAX with *Disk Power* recently complained of a spontaneous cold start when he switches off his Model 102 after using WEETAX. The cold start occurs when the Model 102 is switched back on.

A call to Ultrasoft and some testing revealed that *Disk Power* for the Model 102 uses one byte more at the MAXRAM boundary than is mentioned in the *Disk Power* documentation. It is this single byte at the MAXRAM boundary which conflicts with WEETAX.

Fortunately, BASIC allows an easy fix. Each of the seven programs in WEETAX specifies high memory as MAXRAM-2. This must be changed to MAXRAM-3, providing the necessary byte for *Disk Power* 100/102. See figure 1.

WEETAX.BA	CLEAR 99, MAXRAM-3:
TXPKEY.DO	CLEAR 200, MAXRAM-3:
TXFGET.DO	CLEAR 450, MAXRAM-3:
TXFUPD.DO	CLEAR 4096, MAXRAM-3:
TXFPUT.DO	CLEAR 384, MAXRAM-3:
TXFSUM.DO	CLEAR 384, MAXRAM-3:
TXFSET.DO	CLEAR 384, MAXRAM-3:

Figure 1. Weetax and Disk Power settings.

To fix WEETAX.BA, leave *Disk Power* 100/102 and enter BASIC. Then, with WEETAX installed on the Model 100/102 Main Menu, type Load WEETAX.BA and press ENTER. Next, type Edit and press ENTER. After making the correction, push F8 to leave the editor and F8 again to return to the Main Menu. Move the cursor to DP-100.SY and press ENTER to get the *Disk Power* 100/102 RAM directory. The corrections for the other six programs can be made directly from *Disk Power* 100/102, without entering BASIC. Be sure to save the changes you make.



he OWL..

"On-site Weather Logger",
M100/T102-based outdoor
& indoor environmental
monitoring & control...
...Systems or a-la-carte.

OWL Analog/digital converter...\$185
7 inputs, 8 bits, 0->1.28 vdc.
5 outputs, poweroff, resume timer.

NEW v2.0 HOOT program ROM...\$65
Spreadsheet-ready data, or direct view.
Powerful remark and command entry.

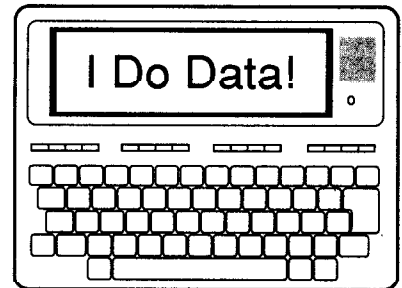

① On-screen data display, 7 lines for 7 channels. Shows data, units, setup info. Also display modes for up to 49 channels.
② Line 8 is for display of battery voltage, free memory, time, date and logging status. Line 8 doubles for display of remarks, commands and queries you type in.

③ Function keys:
F1) to wake the OWL or put it to sleep on a two-minute cycle.
F2) to edit the HOW setup file and return directly to the program.
F5) to enter a remark into the data file. Commands are entered as remarks, to do things like change the logging interval. Commands can change virtually any program parameter. It helps to keep record of all actions right with the data file!
F6) upload the data via any T102 device, i.e., RS232, or run an external transfer program for disk or phone line upload.
F7) look at the current data file and return directly to the program.
F8) exit to T102 menu.

(Circle 85 on reader service card)



eme systems

voice: (510) 848-5725

fax: (510) 848-5748

2229 5th St., Berkeley, CA 94710

WP-2 ARCHITECTURE

Mandatory bussing (and other amazing facts).

by Stan Wong

If you cannot convince them, confuse them.

— Harry S. Truman

The WP-2 is marketed as a word processor rather than as a computer. Correspondingly, most users probably don't care what's under the hood but there are a few of us curious souls that like to tinker and understand how things work. Sadly, the user's manual is of little help. Worse yet, in some cases it's downright misleading! The Tandy tech writers seem to have taken President Truman's words to heart. (I hope I don't do the same here!)

Let's concentrate on the major architectural elements and leave the nuts-and-bolts discussion for a future installment. I'm going to try and educate the (relatively) nontechnical WP-2 user while trying to keep the technonerds awake.

THE USER MANUAL

Let's take a brief look at the user's manual that came with your machine. Page 139 lists the following features:

- Z80-type CPU, 5.5296 MHz
- 256K ROM
- 32K RAM, expandable to 64K
- Parallel port
- Serial port
- Cassette recorder port
- 62-key keyboard
- LCD display
- Expansion card slot

I hate to think that a keyboard and LCD display are touted as features of a word processor! But all seriousness aside, the key features of the WP-2 are the ports, memory, and CPU.

The user's manual doesn't tell you much, just enough to mislead you. For instance, the RAM memory is billed as 32K in size, expandable to 64K. They

don't tell you that the extra 32K of memory can't be used for editing documents. You can use it as a *RAMdisk* to store documents that you aren't working on. Neither do they tell you that you can expand memory by an extra 128K. This information you have to dig out of the WP-2 service manual (which they don't tell you about either).

WP-2 SERVICE MANUAL

The WP-2 service manual is a gold mine of technical information. If your idea of a fun time is reading circuit sche-

**The user's manual
doesn't tell you
much, just enough
to mislead you.**

matics, then this book is for you!

Call the Tandy National Parts Center at (800)442-2425. Be prepared to give them Catalog Number 26-3930 and ask for the service manual. They take plastic so the manual can be on its way to you right away.

GET ON THE BUS

As I mentioned before, the key architectural elements of the WP-2 are an abundance of input/output (I/O) ports, memory, and the CPU. What makes all of this hang together is the *system bus*.

The system bus carries data, address, control, and status information around the system.

The WP-2 system bus is the equivalent of an interstate highway. A local road connects each location to the highway. You get from one location to another by taking a local road to the highway, taking the appropriate exit, and then taking another local road to your destination.

The WP-2 I/O ports are for a printer, serial device, cassette recorder and memory expansion. If the system bus did not exist, the CPU would have a direct connection to every port (and every other device) in the system. You'd wind up with a spaghetti mess of wiring and a more expensive, less reliable system.

With the system bus in place, the WP-2 CPU can send data to a port simply by putting the data on the bus along with address and control information. This is much like sending a letter via the U.S. Postal Service. You put your letter in an envelope (the data), put a destination on the front (address), put a priority mail stamp on it (control), and deposit it in a mailbox (system bus). If you had requested a return receipt you would get notification that the letter was delivered (status).

Hardware cognoscenti might protest that this is an overly simplistic view. I know, but the overall concept is right.

A simple block diagram of the major elements in the WP-2 is shown in Figure 1. Hanging off of the system bus are the system elements that I talked about earlier. I'll discuss as many elements as Nuge allows space for.

EAT FISH

The "brains" of the WP-2 is an NEC

Changes your Model 100 into a totally different computer with capability you never thought possible.

LucidTM
on Snap-InTM ROM

Another fine product from the innovative people at PCSG!

Infoworld
rated Lucid's
performance
"excellent"

**NOW
AVAILABLE
ON
M-200**

**TMNE says "Satisfaction Guaranteed
or your money back within 30 days!"**

LUCID[®] is here now. It is on a ROM cartridge that snaps into the compartment on the back of your Model 100. It takes no memory to load and no memory for operating overhead. That means you have the full 29.6k bytes free to store your data.

First, LUCID[®] is memory conserving. It will let you build a large spreadsheet—255 row by 126 column capacity. You build huge spreadsheets in your Model 100's RAM that could consume 80 to 100K on a desktop computer.

Secondly, LUCID[®] is fast. LUCID[®] is so rapid, a 36 column corporate financial statement took less than 4 seconds to calculate.

Thirdly, LUCID[®] has features you won't find in most other spreadsheets. For example, when you type a label (text) it will cross column boundaries; in other words when you type a label or title it will appear as you type it irrespective of column or width. LUCID[®] also allows you to set column widths individually, and of course LUCID[®] has insert row and insert columns, as well as other standard features. LUCID[®] even lets your formulas refer to cells in other spreadsheet files.

Further, LUCID[®] has what no other spreadsheet has: Cut, Copy, and Paste. It uses the same keys as Cut and Paste in TEXT, but here's the difference: it takes all the formulas with it when you paste and they all automatically recalculate with the entire sheet.

And here is what is really amazing. You can copy or cut from one spreadsheet and paste into another spreadsheet or even a TEXT file.

LUCID[®] supports all BASIC math functions as well as Log, sine, cosine, tangent, exponentiation and other sophisticated math functions.

LUCID[®] has so many features that you will say "this is what I need in a spreadsheet"; such as automatic prompting of an incorrectly typed-in formula showing just where the mistake was made.

LUCID[®] has expanded "go to" functions that remember and produce a windowing capability.

But perhaps most remarkable is that LUCID[®] is not only a spreadsheet but a program generator as well. First, LUCID[®] lets you protect all cells against entry or change, and then unprotect just the cells you want for someone else to use as input fields.

LUCID[®] will not only process values, but text input as well so that the facts other than numbers can be responded to. LUCID[®] has the ability for you to refer in a formula to cells containing words. This feature combines with the capacity of doing "if then" statements that work by doing table look-ups against even massive X/Y charts of text or numerical information. You can produce a program that responds to inputs with no programming knowledge whatsoever.

You can prepare a report section in your spreadsheet with instructions to your user for printout, and they can produce a personalized printout that responds to their input. All your formulas and tables that did the calculations and provided the facts are invisible to that user. LUCID[®] is useful for doctors for patient questionnaires, troubleshooting technicians, purchase clerks, people doing job quotes, stores for customer workups, insurance agents and anybody who needs to process specific facts and numbers to produce a report based on those responses.

LUCID[®] comes with a manual that explains not only the characteristics of LUCID[®], but will train you how to use a spreadsheet even if you have never seen one before. You are shown how to do budgets, forecasts, breakeven analysis amortizations and many other types of personal and business reports and calculations.

User friendly is such an over-used term in this industry, but a typical comment has been "I have never seen a spreadsheet that does so much, and yet LUCID[®] is so much

easier and faster to use."

LUCID[®] is a result of a most exhaustive developmental effort in which PCSG's objective was to develop a spreadsheet that was better than the state-of-the-art. We are so pleased because LUCID[®] provides for the Model 100 spreadsheet capability you cannot equal on a desktop computer.

LUCID[®] is, in our opinion and that of those who have examined it, a breakthrough. We sell it on a 30 day trial. If you are not completely satisfied, return it within 30 days for a full refund. Priced at \$99.95 on snap-in ROM. Please add \$5.00 for shipping and handling. Mastercard, Visa, American Express or C.O.D.
©PCSG 1984, 1991

Distributed by:

**Tri-Mike
Network
East**

1-603-924-8663

**P.O. Box 372,
Peterborough, NH 03458**

Text processing power that no other program can equal.

NOW
AVAILABLE
ON
M-200!

Write ROM[®]

on Snap-in Cartridge \$99.95

(please add \$5.00 shipping and handling charge to your order)

TMNE says "Send it back in 30 days for a full refund if you don't agree."

WRITE ROM is the definitive word processing extension for the Model 100. PCSCG produced the first text formatter for the Model 100, now sold by Radio Shack as Scripsit 100. Now, 18 months later, PCSCG introduced WRITE ROM. Those who have experienced it say WRITE ROM literally doubles the power of the Model 100.

WRITE ROM — as its name implies — is on a snap-in ROM. You simply open the little compartment on the back of the Model 100 with a quarter and press WRITE ROM in. It's as easy as an Atari game cartridge. You can use other ROM programs like Lucid whenever you wish.

WRITE ROM lets you do every formatting function you'd expect, like setting margins, centering, right justifying and creating headers and footers. But it does them under function key control.

WRITE ROM remembers your favorite format settings so you can print a document without any setup, but you can change any formatting or printing parameter instantly with a function key.

WRITE ROM's "pixel mapping" feature shows you an instant picture on the screen of how your printout will look on paper.

In all there are 64 separate features and functions you can do with WRITE ROM, and some of these features are truly breakthroughs for the Model 100.

First, WRITE ROM lets you do search and replace. Any word or phrase in a document can be searched for and replaced with any other phrase where the search words appear.

Second, WRITE ROM lets you send any text (formatted or not) to any other computer over the phone with just a function key. What's more, it dials and handles sign-on and sign-off protocol automatically.

Third, WRITE ROM has a wonderful feature called Library that lets you record favorite phrases, words or commonly used expressions (often called boilerplate).

Any place you wish Library text to appear you just type a code. WRITE ROM automatically inserts the text just like a Xerox Memory Writer. Picture what you can do with that kind of capability.

WRITE ROM is blindingly fast. No one can claim faster operation. Because it is on ROM it uses virtually none of your precious RAM. It works with any printer, serial or parallel. You can make a duplicate copy of a document file under a new filename. Rename or delete (kill) any RAM file with function key ease.

This description only scratches the surface of this amazingly powerful piece of software. Dot commands allow control of such things as margins, centering, line spacing and other changes in the middle of a document. Most are WordStar[™] compatible.

A mailmerge feature allows you to send the same document to every name on your mailing list, personalized for each recipient.

WRITE ROM enables you to do underlining, boldface and correspondence mode as well as any other font feature like superscripts that your printer supports, in a way that many users say "is worth the price of the program."

To underline you don't have to remember a complicated printer code. You just type CODE u, and to stop underline, CODE u again. The CODE key is to the right of your spacebar. Boldface? CODE b to start and stop. Easy to remember and do. Five different printer features of your choice.

We couldn't list all the features here. For example, you can select not just double space but triple or any other. You can use your TAB

key in a document. WRITE ROM allows you to indent. This means you can have paragraphs with a first line projecting to the left of the rest of the paragraph. WRITE ROM has a feature unique for any word processor on any computer. It's called FORM. FORM is an interactive mechanism that lets you create screen prompts so that you or someone else can answer them to fill out forms or questionnaires.

With FORM, any place that you had previously typed a GRAPH T and a prompt in a document, WRITE ROM will stop and show you that prompt on the screen. You can type in directly on the screen and when you press F8 you see the next prompt. It goes to a printer or a RAM file.

Think how you can use FORM. A doctor or nurse could use it for a patient's history with each question appearing on the screen. An insurance salesman could use it for his entire questionnaire. You could construct a series of prompts to answer correspondence, typing the answers, even using Library codes. This feature lets you answer letters in rapid-fire fashion, each with personalized or standard responses.

Before WRITE ROM you had to be a programmer to create a series of prompts. Now it's as simple as GRAPH T.

PCSCG makes the claim that WRITE ROM is the easiest, fastest and most feature-rich formatter for the Model 100. We're happy to offer WRITE ROM because it expands the 100 to a dimension of text processing you cannot equal on even larger computers.

We brashly state that WRITE ROM is the best you can buy. But put that to the test. If you aren't as excited as we are, return it for a full refund. Priced at \$99.95 on snap-in ROM. Mastercard, Visa, American Express and COD. Please add \$5.00 shipping and handling charge.

Distributed by:

Tri-Mike Network East

P.O. Box 372, Peterborough, NH 03458

1 (603)

924-8663

VISA / MASTER CARD / AM. EXP. / C.O.D.

Another fine product from the innovative people at PCSCG!

Circle 71 on reader service card

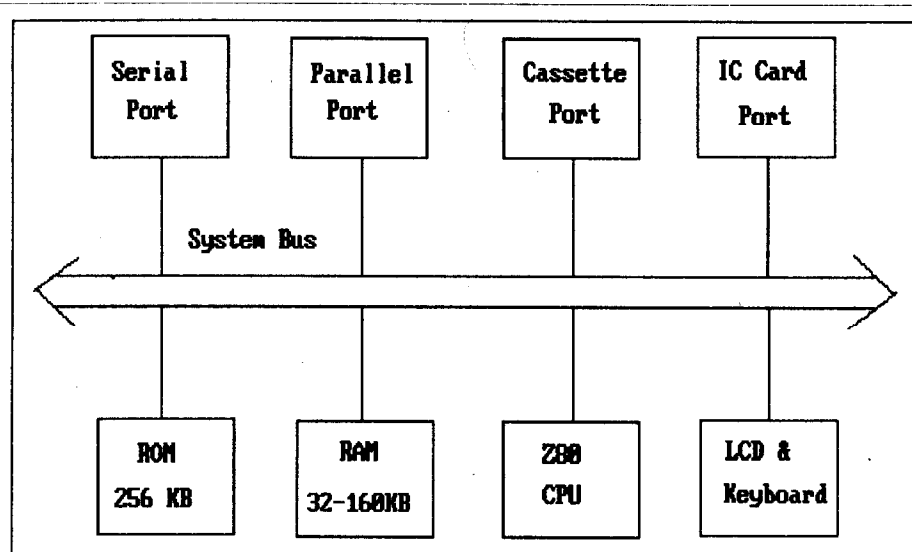

Figure 1. WP-2 System Bus.

uPD700008A-6, which is essentially an updated version of the venerable Zilog Z80 microprocessor. I'll refer to the WP-2 processor as a Z80 for simplicity.

The Z80 is an 8-bit processor, which means that many of the instructions work on data in 8-bit chunks. Model 100 fans should feel right at home. The Z80 is essentially a superset of the Intel 8085 microprocessor with the exception of a couple instructions. It is a true superset of the old Intel 8080 processor used in early CP/M machines. The Z80 adds a few new functions, which means that some programs can use fewer instructions to perform the same function as an 8085 would require.

The Z80 is *code compatible* with the 8080/8085. Model 100 assembly language programmers wouldn't recognize a Z80 program because the two processors are not *mnemonic compatible*. Consider the following Z80 instruction to load the number 32 to the accumulator:

```
LD A,20H
```

The 8080/8085 instruction to do the same is

```
MVI A,20H
```

The instructions, or mnemonics, are different, but both instructions compile to a value of 3E20H. Simple 8080/8085 functions can run on a Z80 as long as the binary code values are used rather than the assembly language mnemonics.

Programmers for the 8085 can write code for the WP-2 Z80 and use their current 8085 assemblers. They won't be able to access the extra Z80 instructions though.

Z80 programmers can write code for

the Model 100 and use their current assembler as long as they are careful to avoid the Z80 extensions to the 8085 instruction set.

Before you get your hopes up, Model 100 programs will not likely run on the WP-2. This is a generalization, but most practical programs deal heavily in I/O whether it's the keyboard, memory, or screen. The WP-2 method of dealing with these items is different from the Model 100. The general principles are the same, so translating a program may not be too difficult, however.

PORTS-O-CALL

The great thing about the WP-2 is its abundance of I/O ports. The serial port, parallel port, cassette port, and IC card memory port give the WP-2 an unparalleled flexibility to acquire and send data.

Unfortunately, its greatest promise lies in the IC card memory port. Tandy promised that third party developers would deliver application programs via this port. None ever materialized.

The WP-2 could have been a great machine if the right applications were delivered. For instance, how about a spreadsheet application? Not too unusual. But since the WP-2 is a word processor, how about a cut-and-paste function allowing you to put your spreadsheet directly into your document?

FORGET ME NOT

The WP-2 memory also sits on the system bus. The memory is divided into two types: random access memory (RAM) and read-only memory (ROM). The RAM area holds your documents and parts of the operating system. The ROM area holds most of the operating system, dictionary, and thesaurus.

TANDY WP-2 MEMORY

128K \$54
32K \$12

Improve your memory! Add a 32K or 128K ram disk to your WP-2. The 32K part is exactly the same as Tandy's at a significantly lower price. The 128K part has the same low power characteristics of the 32K part. Battery life is not a problem! Prices include S&H, installation instructions, 90-day warranty. CA residents add 7.75% tax. Send check or money order to:



MicroMime

P.O. Box 28181
Santa Ana, CA 92799

CIS 70346,1267 Phone/Fax (714) 545-1765

Circle 37 on reader service card.

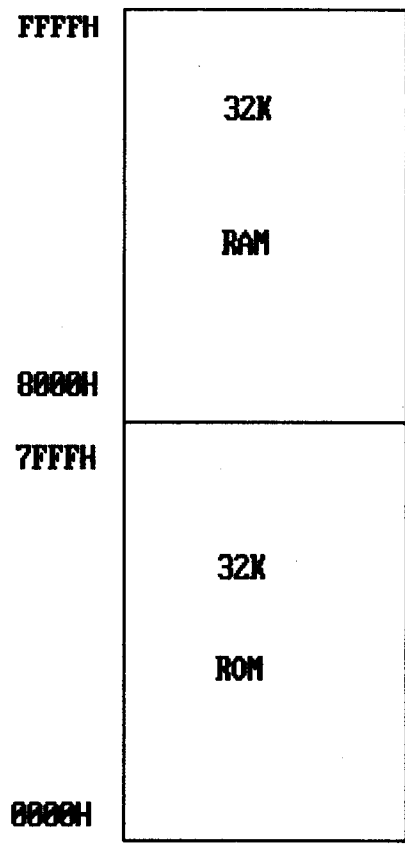

Figure 2. WP-2 Memory Map.

The Z80, being an eight-bit CPU, can address only 64K of memory (just like the Model 100 8085 CPU). The first 32K of address space is allocated to ROM (addresses 0000H through 7FFFH) and the upper 32K to RAM (8000H through FFFFH). See Figure 2. This is the same memory allocation as found in the Model 100 family.

Your own Program on a Rom

8K or
32K

Your BASIC
or machine code
program on a custom
ROM ready to snap into
your Model 100 or
Tandy 200.

You can't tell your
program from a built-in.
Starting at \$50.00 each.

Minimum order of 10.
Quantity pricing as low

as
\$15.00

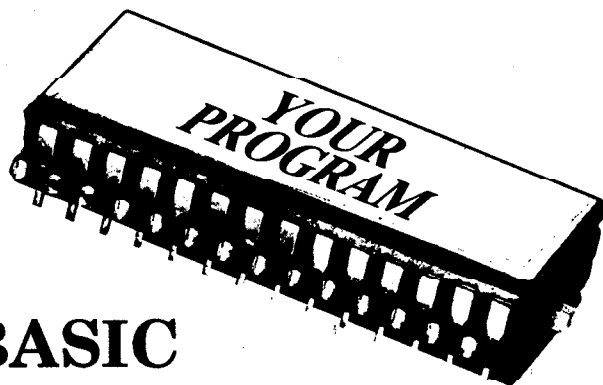

Distributed by

Another fine product
from the innovative people at PCSG

Tri-Mike Network East

Post Office Box 372 Peterborough, NH 03458

1-603-924-8663

VISA MASTERCARD C.O.D

F1/F2 — WP-2

BAIT AND SWITCH

The WP-2 has 256K of ROM and can support up to 160K of RAM. But wait, you ask! How can this be? The Z80 can only address 64K of memory and you just finished by saying that memory is divided in 32K RAM/ROM segments. The WP-2 uses a technique called *bank switching* to access more memory. This technique fools the microprocessor into thinking that you have only 64K of memory when you actually have more.

Think of the WP-2 RAM and ROM address space as peepholes. The system memory is divided into equal sized *banks* of memory. Circuitry external to the microprocessor swaps the appropriate bank of memory into the Z80 address space. In essence, the Z80 address space is a *peephole* into the larger WP-2 address space, and the Z80 doesn't know the difference.

Programmers for
the 8085 can write
code for the
WP-2 Z80 and
use their current
8085 assemblers.

NEED A TRANSFER

Well, I've managed to run out of memory in my word processor, so I'll have to continue this discussion at another time. It's time for me to grab a transfer and get off the (WP-2) bus. Until then, don't forget to write.

This is your column. I want you to help define the "yellow brick road" for me to follow. Fire up your WP-2 and send me a letter in care of Portable 100 or directly at P.O. Box 28181, Santa Ana, CA 92799-8181. If you prefer the electronic medium, use GENIE address STAN.WONG, Compu-Serve address 70346,1267, or Internet address dasun!wongs@Sunkist.West.Sun.Com.



Circle 75 on reader service card.

The Portable 100 Classifieds

SOFTWARE

FAST (tm) 3x turbo cassette LOAD/SAVE utility for Tandy M100/102, M200 (specify). See 11/89 P100 review. SASE for information. Cassette, manual \$19.95 ppd. Zwillenberg. 475 Richmond. Maplewood, NJ 07040

HARDWARE

Model 100 32K with Super Rom
\$275.00 firm. Call (308)527-3506.

Model 100 32K, Multiplan ROM, DV/I, Modem, Cable, Recorder, Software, book, \$450.00; C. Itoh printer \$150.00. (812)853-3297.

Tandy 102 32K, Portable Disk Drive & portable Brother printer \$350.00; Tandy 1100FD 640K and modem \$450.00. (213)828-1997.

TRS-80 Model 100 32K, Super ROM, case, legs, adapter, seven software packages,

books. Needs new LCD screen. \$199.00. Peirce, 2948 Blairstone Ct., Tallahassee FL 32301.

EMM, integrated ExtRAM/RAM/PDD-1&2 file manager. Runs in-ExtRAM, utilizing unoccupied space for file storage. Features aggregate file selection and file compression. Send SASE for information or \$15.00 for disk. TPSIG, P.O. Box 684473, Austin TX 78768-4473.

Record voltage or other analog parameters with your 100/102/200. DATAMITE A/D converter connects to cassette jack, software provides voltage readout and/or emulates scrolling chart recorder on your Tandy screen. \$66 + \$4 S&H: Jones Service & Design, 1842 S. Nugent Rd., Lummi Is., WA 98262. (206)758-7258.

Data Acquisition with M100/102. REI. RR1 Box 113F, Royalton, VT 05068. (802)763-8367. 10/91

Tandy 100, 32K,PDD, DMP-130 printer, software, cables, manuals. \$375. (312-644-0638 6/92

FOR SALE

TRS-80 Model 100, includes VDI w/TWO 5.25" drives, HARD carrying case, MOST accessories, plus Amber monitor, VGC; package only. \$675 Negotiable (708) 837-8741. 7/92

Tandy 200 with disk video interface, Tandy software, modem cable, cassette cable, cassette player, and computer adapter. \$250. Linda (717) 566-5411. 6/92

M100 w/24k, AC power; legs; Epson Spectrum LX-80 printer; cassette drive CCR-82; All cables & manuals; all: \$250 (ship included) 808-943-1133 4/92

WP-2 ROM simulator card! Plugs into the expansion card slot of the WP-2. Holds up to four 256Kbit EPROM's or two 1Mbit EPROM's. \$89.95 each. Midwest DataCard Marketing (513) 433-2511 12/90

T100-32K with Video/Disk Interface, acoustic coupler, recorder, software. Package only \$595. EC. Dominic, 215-339-5848 6/91

Two Model 100's with ROMS. One 100K FDD Acoustic Coupler and assorted software. Call or write for description and price.. Like new. PO Box 3104 Mankato. MN 56001 (507) 726-2704

WANTED

WANTED, NEC PC-8300's like new or good condition only. (216) 531-2185, ext. 12. 6/93

HOW TO PLACE A CLASSIFIED AD

Categorize your advertisement (Hardware, Software, Services, Wanted, Etc.) and carefully type your message. We are not responsible for correctly interpreting handwritten advertisements. Phone numbers, street numbers, dimensions, and any abbreviations count as one word. Logos, company or product, are not allowed, neither are display advertisements. Business rates are 90¢ per word; non-business rates (individuals advertising) are 60¢ per word. Add up the cost and send the advertisement copy with a check, money order, Visa, or Mastercard number to: Portable 100 Classifieds, 145 Grove St. Ext., P.O. Box 428, Peterborough, NH 03458-0428, c/o Linda Tiernan. Make checks payable to Portable 100 Classifieds. Include your complete return address and phone number (phone number is printed only if it is included in the advertisement itself). Materials due the 1st of the month. two months prior to the magazine cover date (example: materials for the February issue must be received by December 1st.) Advertisements received after the deadline will appear in the next scheduled issue. Payment must accompany order. No refunds for advertisements that miss deadlines, regardless of reason. We reserve the right to change advertisement categories, and to reject, edit, or cancel any advertisement we deem improper. There are no agency discounts for classifieds. For faster service call 603-924-9455.

Ad Category _____ No. of words x (90¢)(60¢) _____ #Issues to run _____

Name _____

Address _____

City _____ State _____ Zip _____

Total Enclosed x (Ad Cost x Issues) _____ Phone Number _____

Visa/Mastercard Number _____ Exp. Date _____

Signature _____

New LOW Rates!

Businesses—90¢ per word
Non-business—60¢ per word
Find those items you need, sell the ones you don't, start a business inexpensively!

Low-Profile Null Modems!

These ultra-small null modem connectors let your Model 100, 102, 200, 600 or MS-DOS computer talk directly to any other computer. So small and light you can always keep it right with your computer!

Direct connections in half the space!
Drawing is ACTUAL SIZE!

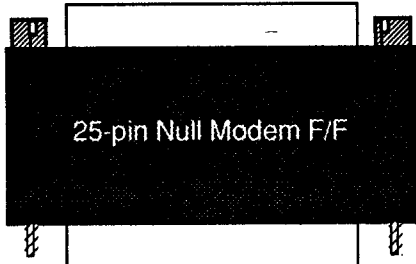

25-pin Male-to-Male, Male-to-Female, or Female-to-Female

only \$20.00ea

The internal pin connections are:

1-1, 2-3, 3-2, 4-5, 5-4, 6&8-20, 20-6&8, 7-7

Portable 100—Hardware

P.O. Box 428, 145 Grove St. Ext.

Peterborough, NH 03458-0428

(603) 924-9455

Visa, MasterCard, Amex accepted.

Please allow 2-3 weeks for delivery

Circle 19 on reader service card.

ADVERTISER'S INDEX

Free Information

For free information on products advertised in this issue of Portable 100, locate the Reader Service number corresponding to the advertisement that interests you. Circle the number on the Reader Service Card at page 23 (or on the protective mailing wrapper if you are a subscriber) and drop it into the mail. The literature you've requested will be forwarded to you without any obligation. Please allow 3-5 weeks for delivery.

ADVERTISERS

RS#		Page
09	ADPI	3
150	Amherst International	CII
34	Anvil Cases	31
180	Automap Inc.	CIV
165	Club 100: A Model 100 User Group	1
171	Club 100: A Model 100 User Group	7
33	Club 100: A Model 100 User Group	21
154	Computer Reset	15
05	Destiny Technology	12
85	EME Systems	37
81	EME Systems	22
116	King Computer Services	29
37	MicroMime	41
149	MicroMime	15
175	Micro-Ref	8
190	Optical Data	32
45	Pacific Computer Exchange	7
121	Paul Globman	8
117	Portable 100—Gender Changer	12

ADVERTISERS

RS#		Page
19	Portable 100—Null Modem	44
55	Purple Computing	12
128	Software Versand	13
18	System Peripheral Consultants	13
99	Solarmetrics	7
71	Tri-Mike Network East-WR	40
73	Tri-Mike Network East-D+	17
75	Tri-Mike Network East-CR	42
74	Tri-Mike Network East-Lucid	39
72	Tri-Mike Network East-SR	5
134	Ultrasoft Innovations	19
153	Venture 2000	CIII

New Products

62	LapPac Corp.	34
68	Brother International Corp.	34
65	Lucid Corp.	35
69	MicroLogic	35
67	Multisoft	35
66	SemWare	34
63	Statpower Technologies	35
64	U.S. Robotics	34

FINGERS TIRED?

Accomplish more... in less time.
Get the P100-To-Go program disk.

Make your life easier! Save hours of time from typing in lengthy programs. Never worry again about typing errors. Have more fun with *Portable 100's* new disk-of-the-month service. Every program from the magazine is included on each month's disk. No typing. No trouble.

We make it easy and inexpensive. You deserve value. At *Portable 100* we believe in value. That's why we're not only making each month's programs available on 100K Tandy Portable Disk Drive disks (which work in 200K drives), we're also



making sure any extra room on each disk is packed with interesting and fun bonus programs. All files are in .DO format. Ready to load. Ready to go.

Not just for the Tandy 100. The *P100-To-Go* disks will work with any computer that uses the Tandy Portable Disk Drive, the Brother FB100, and the Purple Computing Portable Disk Drive. This means your NEC-8201/8300, Tandy 100/102, Tandy 200, Olivetti M10, and Kyotronic KC-85 can all load these programs into memory (once loaded, changes for specific computer models may be required, refer to corresponding program article for information about compatibility with particular computers).

Subscribe and save! You can order *P100-To-Go* disks individually at only \$9.95, but for maximum savings sign up for our **Six-pack Special**, one disk each month

Yes! Save me hours of typing time. Sign me up for your **Six-pack Special** (6 monthly disks of the *Portable 100* programs, plus the special bonus programs included with every disk) for only \$47.70.

- P100-To-Go** 1988 disk set (Jun.-Dec. 1988) \$47.70.
 P100-To-Go 1989 disk set A (Jan.-Jun. 1989) \$47.70.
 P100-To-Go 1989 disk set B (Summer '89.-Feb. 1990) \$47.70.

Individual P100-To-Go disks at \$9.95

- Jun '88 Jan '89 Sum '89 Mar '90 Apr '91
 Jul/Aug '88 Feb '89 Oct '89 Apr '90 May '91
 Sep '88 Mar '89 Nov '89 May '90 Jun '91
 Oct '88 Apr '89 Dec '89 Nov. '90 Jul/Aug '91
 Nov '88 May '89 Jan '90 Dec. '90 Sep '91
 Dec '88 Jun '89 Feb '90 Mar. '91 Oct '91

To place your order immediately, call:

603-924-9455

Prices include postage and handling. Please allow 4-6 weeks for delivery. Foreign airmail add \$2 per disk. All foreign, US Funds drawn on US banks only.

- Payment enclosed (check or money order)
 MasterCard VISA Amex

CARD NUMBER _____ EXP. DATE _____

SIGNATURE _____

NAME _____

STREET ADDRESS _____

CITY _____

STATE _____

ZIP _____

Mail to: Portable 100, P100-To-Go,
P.O. Box 428, Peterborough, NH 03458-0428

It Doesn't Take An Expert To Know What's Needed For Every Notebook And Laptop Computer

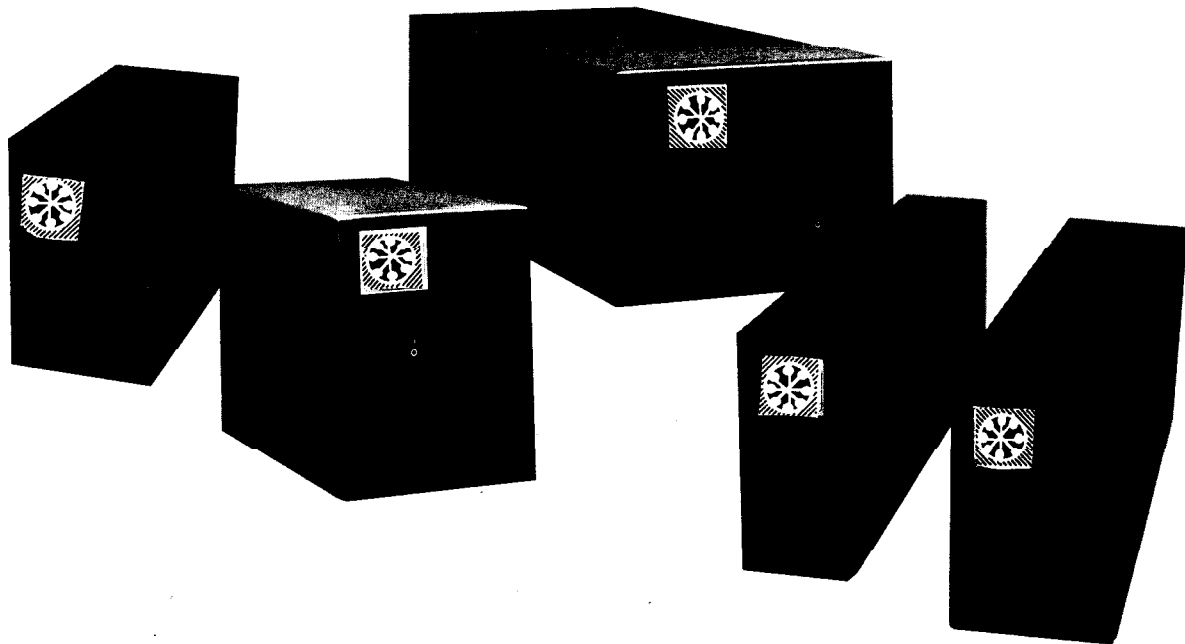

We can tell you in *Four Words* !!!

PARALLEL PORT EXPANSION CHASSIS

4 DISTINCTIVE MODELS available in 2-slot, 3-slot, 5-slot and 8 slot, **THAT CONNECT DIRECTLY TO THE PARALLEL PORT.** All models have their own power supply which **ELIMINATES ANY MAJOR BATTERY DRAINAGE** from your notebook or laptop.

You can operate with standard 8 bit or 16 bit (AT/XT) and you can use either **FULL-SIZE OR HALF-SIZE CARDS.** Parallel port expansion chassis **OPERATES WITH MS-DOS AND IBM COMPATIBLES SPECIFICALLY.**

This product line is unique in that **IT IS NOT PROPRIETARY RELATED.** You aren't required to use a single manufacturer's computer product. The expansion chassis **WILL OPERATE WITH MOST NOTEBOOKS AND LAPTOPS,** unlike other products which are designed for a specific manufacturer.

MULTI-APPLICATION VERSATILITY IS THE KEY for the Parallel Port Expansion Chassis. Unlike other products which are single function only, **YOU CAN ADD INTERNAL HIGH COMPUTING POWER AND STORAGE POWER** with hard drives (20 MB - 600MB), Floppy (1.2MB-1, 1.4MB-360K), and tape drives (up to 250MB) depending on the model you select.

OTHER BENEFITS: Simple setup and operation, rugged design, plus all models are in a self contained case.

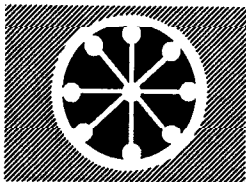

CALL US TODAY! (804) 741-7692 FAX # (804) 741-8349

VENTURE 2000 LTD

10404 PATTERSON AVENUE

RICHMOND, VA, 23233

Circle 153 on reader service card

Explore Outer Space The Human Race and Every Place.

ORBITS Voyage Through the Solar System™



Journey beyond the sky to the rings of Saturn, the mountains of the moon and the core of the sun with ORBITS—Voyage Through the Solar System. Combining colorful animation, 3-D graphics and

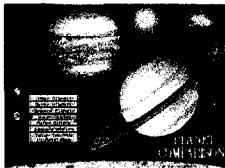

actual satellite photographs, ORBITS is an interactive space simulator, atlas of the solar system and scientific adventure.

\$59⁹⁵



**SOFTWARE
MARKETING
CORPORATION**

*Orbits System Requirements: IBM PC or compatible, 512K memory, MS-DOS 2.0 or above, EGA or VGA color graphics, 5.25" or 3.5" disk drive.
(Optional) Microsoft Mouse or compatible.*

BODYWORKS An Adventure in Anatomy™



Explore the universe of inner space with BODYWORKS—An Adventure in Anatomy. Comprehensive, full-color computer graphics lead you on a fantastic voyage into the systems, structures and functions of

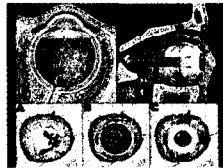

the human body. By accessing a vast database, you can focus on different internal systems.

\$79⁹⁵

To Order Call

1-800-545-6626

or FAX (602) 893-2042

9831 S. 51st St. Building C-113 Phoenix, AZ 85044

*Bodyworks System Requirements: IBM PC or compatible, 512K memory, MS-DOS 2.2 or above. Hard disk drive (uses 25MB). VGA or EGA displays, 5.25" or 3.5" disk drive.
(Optional) Microsoft Mouse or compatible.*

AUTOMAP™ The Intelligent Road Atlas™



The fun, fast, friendly way to know before you go. Full-color maps help you plan your best route. Accurate, current and reliable data. Print out detailed maps and directions to take along with you.



AUTOMAP can easily save up to 20% in driving time and costs.

\$99⁹⁵

AUTOMAP™
INCORPORATED

*AUTOMAP System Requirements: IBM PC or compatible, 512K memory, MS-DOS 2.2 or above. Hard disk drive (uses 4MB). Super VGA, VGA, EGA, CGA, or Hercules, 5.25" or 3.5" disk drive.
(Optional) Microsoft Mouse or compatible.
Printers: From Dot Matrix to PostScript, from Black Ribbon to 16 Color, 9 Pin to Laser.*

SUBSCRIPTION FORM

YES! Offer expires January 1, 1993

I want 11 issues of *Portable 100* monthly except for a combined July/August issue) and save 54% off the newsstand price.

- One Year US\$19.95* Two Years US\$34.95* Three Years US\$49.95*
 Check enclosed Bill me MC VISA

Card # _____

Expiration Date _____

BE SURE TO INCLUDE ENTIRE CARD NUMBER

NAME _____ STATE _____ ZIP _____
 COMPANY NAME _____
 ADDRESS _____
 CITY _____

* Canada & Mexico add US\$5 per subscription year, all other foreign add US\$20. Foreign Airmail, add US\$50 per subscription year. All foreign, except Canada, US Funds drawn on US bank.

1. Which Portable(s) do you own?

- Model 100/102 T1400LTFD/HD Apple
 Tandy 200 NEC-8201A Commodore 64/128 Other _____
 Tandy 600 Kytronic KC-85 Do you use your portable for...
 Olivetti M10 Olivetti M10 A. Business Personal Both
 T1100FD J. Other _____

2. If you own another computer, what kind is it?

- A. MS-DOS C. Amiga
 B. Macintosh D. Atari ST

4. If you are responsible for more than one portable, what is the quantity? _____

Renewal 3

TERRY KEPNER'S

portable 100

Reader Service Card

May 1992
Valid until
June 28, 1992

Name _____

Company _____

Address _____

City _____ State _____ ZIP _____ Phone No. _____

- 1. Which Portable(s) do you own?**
- A. Model 100/02 D. Tandy WP-2 G. NEC-8201A
 B. Tandy 200 E. T1100FD H. Olivetti M10
 C. Tandy 600 F. T1400LTFD/HD I. Kytronic KC-85
 Other _____

2. If you own another computer, what kind is it?

- A. MS-DOS E. Amiga
 B. Macintosh F. Atari ST
 C. Apple G. Other _____
 D. Commodore 64/128

3. Do you use your portable for...

- A. Business B. Personal C. Both

4. If you are responsible for more than one portable, what is the quantity? _____

5. If you are not a subscriber, please circle 199 (at right).

If you would like a one year subscription to *Portable 100*, please circle 200 (at right). Each subscriber is US\$19.95 (one year). Canada and Mexico US\$24.95. All other foreign US\$36.95. Foreign Airmail add US\$50 per subscription. All foreign, except Canada, US funds drawn on US Bank.

1	26	51	76	101	126	151	176
2	27	52	77	102	127	152	177
3	28	53	78	103	128	153	178
4	29	54	79	104	129	154	179
5	30	55	80	105	130	155	180
6	31	56	81	106	131	156	181
7	32	57	82	107	132	157	182
8	33	58	83	108	133	158	183
9	34	59	84	109	134	159	184
10	35	60	85	110	135	160	185
11	36	61	86	111	136	161	186
12	37	62	87	112	137	162	187
13	38	63	88	113	138	163	188
14	39	64	89	114	139	164	189
15	40	65	90	115	140	165	190
16	41	66	91	116	141	166	191
17	42	67	92	117	142	167	192
18	43	68	93	118	143	168	193
19	44	69	94	119	144	169	194
20	45	70	95	120	145	170	195
21	46	71	96	121	146	171	196
22	47	72	97	122	147	172	197
23	48	73	98	123	148	173	198
24	49	74	99	124	149	174	199
25	50	75	100	125	150	175	200

Renewal 2

IT'S TIME TO RENEW!

We don't want to lose you! But if you look at the date which follows your name on the mailing label below (in year, month, day order—YYMMDD), you'll discover that it's been just about a year. YOUR SUBSCRIPTION IS RUNNING OUT. To keep receiving *Portable 100*, simply fill out the form below and return it to us (the postage is already paid). For even faster service call us at (603) 924-9455. Don't get left out, renew your subscription today!

Subscription Renewal Form.

- Check enclosed Visa Mastercard Am. Express.

Card number _____ You must include the expiration date! Expiration Date _____

Signature _____

Be sure to include both your old and new address if you've moved recently!

Portable 100 (ISSN#0888-0131)
P.O. Box 428
Peterborough, NH 03458

BULK RATE
U.S. POSTAGE PAID
PITTSFIELD, MA 01201
PERMIT # 137.

- 1 Year \$19.95
 Canada/Mexico US\$24.95
 Foreign US\$39.95
 2 years \$34.95
 Canada/Mexico US\$44.95
 Foreign US\$74.95
 3 years US ONLY \$49.95

All foreign, except Canada, US Funds drawn on US Bank. Foreign Air Mail, add us\$50 per subscription year.

Type of computer you own. We would like to hear your comments and suggestions. Please include them

Renewal