



8Xmax DVD-ROM
Drive with Software
MPEG-2 Option Kit

Black 8Xmax
DVD-ROM Drive

User's Guide

Note: Before using this information and the product it supports, be sure to read the information under Appendix D, "Product warranty and notices" on page 3-14.

First Edition (November 1999)

The following paragraph does not apply to the United Kingdom or any country where such provisions are inconsistent with local law: INTERNATIONAL BUSINESS MACHINES CORPORATION PROVIDES THIS PUBLICATION "AS IS" WITHOUT WARRANTY OF ANY KIND, EITHER EXPRESS OR IMPLIED, INCLUDING, BUT NOT LIMITED TO, THE IMPLIED WARRANTIES OF MERCHANTABILITY OR FITNESS FOR A PARTICULAR PURPOSE. Some states do not allow disclaimer of express or implied warranties in certain transactions, therefore, this statement may not apply to you.

This publication could include technical inaccuracies or typographical errors. Changes are periodically made to the information herein; these changes will be incorporated in new editions of the publication. IBM may make improvements and/or changes in the product(s) and/or the program(s) described in this publication at any time.

This publication was developed for products and services offered in the United States of America. IBM may not offer the products, services, or features discussed in this document in other countries, and the information is subject to change without notice. Consult your local IBM representative for information on the products, services, and features available in your area.

Requests for technical information about IBM products should be made to your IBM reseller or IBM marketing representative.

Copyright International Business Machines Corporation 1999. All rights reserved.

Note to U.S. Government Users — Documentation related to restricted rights — Use, duplication or disclosure is subject to restrictions set forth in GSA ADP Schedule Contract with IBM Corp.

Contents

Safety: Read first	iv
Registering your option	vi
About this book	vi
<hr/>	
Part 1: Installation and user's guide	1-1
<hr/>	
Part 2: Care and maintenance guide	2-1
Caring for a CD or DVD	2-1
Caring for the DVD-ROM drive	2-1
Loading a disc into the DVD-ROM drive	2-2
Manually ejecting a disc	2-3
<hr/>	
Part 3: Appendixes	3-1
Appendix A. Customizing device-driver configuration settings	3-1
Appendix B. Problem solving	3-8
Appendix C. Help and service information	3-13
Online technical support	3-13
Telephone technical support	3-13
Appendix D. Product warranty and notices	3-14
Warranty Statements	3-14
Notices	3-23
Trademarks	3-24
Electronic emission notices	3-24

Safety: Read first



Before installing this product, read the Safety Information.

Antes de instalar este produto, leia as Informações de Segurança.

在安装本产品之前，请仔细阅读 **Safety Information** (安全信息)。

Prije instalacije ovog produkta obavezno pročitajte Sigurnosne Upute.

Před instalací tohoto produktu si přečtěte příručku bezpečnostních instrukcí.
Læs sikkerhedsforskrifterne, før du installerer dette produkt.

Ennen kuin asennat tämän tuotteen, lue turvaohjeet kohdasta Safety Information.

Avant d'installer ce produit, lisez les consignes de sécurité.

Vor der Installation dieses Produkts die Sicherheitshinweise lesen.

Πριν εγκαταστήσετε το προϊόν αυτό, διαβάστε τις πληροφορίες ασφάλειας (safety information).

A termék telepítése előtt olvassa el a Biztonsági előírásokat!
Prima di installare questo prodotto, leggere le Informazioni sulla Sicurezza

製品の設置の前に、安全情報をお読みください。

본 제품을 설치하기 전에 안전 정보를 읽으십시오.

Пред да се инсталира овој продукт, прочитајте информацијата за безбедност.

Lees voordat u dit product installeert eerst de veiligheidsvoorschriften.

Les sikkerhetsinformasjonen (Safety Information) før du installerer dette produktet.

Przed zainstalowaniem tego produktu, należy zapoznać się z książką "Informacje dotyczące bezpieczeństwa" (Safety Information).

Antes de instalar este produto, leia as Informações sobre Segurança.

Перед установкой продукта прочтите инструкции по технике безопасности.

Pred inštaláciou tohto zariadenia si pečítajte Bezpečnostné predpisy.

Pred namestitvijo tega proizvoda preberite Varnostne informacije.

Antes de instalar este producto lea la información de seguridad.

Läs säkerhetsinformationen innan du installerar den här produkten.

安裝本產品之前，請先閱讀「安全資訊」。

Registering your option

Thank you for purchasing OPTIONS by IBM . Please take a few moments to register your product and provide us with information that will help IBM to better serve you in the future. Your feedback is valuable to us in developing products and services that are important to you, as well as in developing better ways to communicate with you. Register your option on the IBM Web site at:

<http://www.ibm.com/pc/register>

IBM will send you information and updates on your registered product unless you indicate on the Web site questionnaire that you do not want to receive further information.

About this book

This manual contains information on the IBM 8Xmax DVD-ROM Drive. It is divided into the following parts:

Part 1: Installation and user's guide

This section contains the product description and installation and operating instructions in the following languages: English, German, French, Spanish, Italian, Brazilian Portuguese, and Japanese.

Part 2: Care and maintenance guide

This section contains care and maintenance instructions for the DVD-ROM drive and the discs used with the drive.

Part 3: Appendixes

This section contains device-driver configuration settings, problem-solving, service, warranty, and notice information.

Be sure to retain your proof of purchase. It might be required for warranty service.

Note: The illustrations in this manual might be slightly different from your hardware.

Part 1: Installation and user's guide

This section contains the product description, hardware and software installation instructions, and operating information.

Product description

You have received one of the following option packages:

IBM 8Xmax Internal IDE DVD-ROM Drive with Software MPEG-2

This drive comes with a software CD containing an MPEG-2 decoder for Microsoft Windows 98, Windows 95 OSR2, and Microsoft Windows NT 4.0 Workstation.

In addition to this book, the option package includes:

- IBM 8Xmax DVD-ROM Drive
- Four mounting screws (M3 x 5 mm, slotted)
- IDE cable for connecting two IDE devices
- Two white faceplates for use with certain computers
- Two internal audio cables
- WinDVD* MPEG-2 software CD
- 8Xmax DVD-ROM Drive Option Diskette*
- Safety information manual
- Laser Safety Guide*

IBM 8Xmax Black Internal IDE DVD-ROM Drive

You can use this drive to play MPEG-2 DVD video files in Windows 98, Windows 95, or Windows NT 4.0 only if you install an MPEG-2 adapter (not included) in your computer. However, you do not need to install an MPEG-2 adapter to use the drive as a *data-only* DVD-ROM drive or as a CD-ROM drive.

In addition to this book, the option package includes:

- IBM 8Xmax DVD-ROM Drive
- Four mounting screws (M3 x 5 mm, slotted)
- IDE cable for connecting two IDE devices
- One black faceplate
- Two internal audio cables
- 8Xmax DVD-ROM Drive Option Diskette*
- Safety information manual
- Laser Safety Guide*

Your drive can read many DVD and CD formats, including DVD video, Video CD, and audio CD formats. However, you must install a video decoder to read video files. The drive also reads multiple-session, extended architecture (XA) discs, such as the Kodak Photo CD. When used as a CD-ROM drive, this drive delivers data at up to 40 times the standard CD-ROM speed (40X). The DVD-ROM drive is designed for installation in a personal computer that uses the integrated drive electronics (IDE) or enhanced IDE (EIDE) architecture.

Contact your place of purchase if an item is missing or damaged. Be sure to retain your proof of purchase. It might be required to receive warranty service. See Appendix C, "Help and service information" on page 3-13 for technical support information.

Software description

The IBM 8Xmax Internal IDE DVD-ROM Drive with Software MPEG-2 option kit includes the following software:

WinDVD MPEG-2 software CD

With the *WinDVD* software, you do not need to install an MPEG-2 adapter in your computer to view DVD video files. The *WinDVD* software CD contains an MPEG-2 decoder and programs that work with Windows 98, Windows 95 OSR2, and Windows NT 4.0. You can use the software to play high-resolution DVD movies or MPEG-2 files with MPEG-2 video and Dolby AC-3 audio on a multimedia computer.

8Xmax DVD-ROM Drive Option Diskette

The *8Xmax DVD-ROM Drive Option Diskette* contains device drivers for Windows 98, Windows 95, Windows NT 4.0, Windows 3.x, IBM OS/2, and DOS that you can use to access the drive as a *data-only* DVD-ROM drive or as a CD-ROM drive in DOS mode. The diskette also includes an audio CD-player program for DOS and a diagnostic program.

The IBM 8Xmax Black Internal IDE DVD-ROM Drive option kit includes the following software:

8Xmax DVD-ROM Drive Option Diskette

The *8Xmax DVD-ROM Drive Option Diskette* contains device drivers for Windows 98, Windows 95, Windows NT 4.0, Windows 3.x, OS/2, and DOS that you can use to access the drive as a *data-only* DVD-ROM drive or as a CD-ROM drive in DOS mode. The diskette also includes an audio CD-player program for DOS and a diagnostic program.

Installation requirements

If you received the IBM 8Xmax Internal IDE DVD-ROM Drive with Software MPEG-2, be sure that your computer meets the following system requirements before installing the drive:

- Minimum microprocessor: Intel Pentium II 333 MHz
- Minimum RAM: 32 MB
- Windows 98, Windows 95 OSR2, or Windows NT 4.0 operating system if you will be using the *WinDVD* MPEG-2 software CD
- Windows 98, Windows 95, Windows NT 4.0, Windows 3.x, OS/2, or DOS operating system if you are going to use the drive as a *data-only* DVD-ROM drive or as a CD-ROM drive in DOS mode
- Available drive bay
- 3.5-inch diskette drive to load the included device drivers if you are going to use the drive as a *data-only* DVD-ROM drive or as a CD-ROM drive in DOS mode
- Available IDE connection
- 20 MB¹ available hard disk drive space
- Audio adapter supporting 44.1 or 48 KHz sampling rate
- Optional stereo speakers

If you received the IBM 8Xmax Black Internal IDE DVD-ROM Drive, be sure that your computer meets the following system requirements before installing the drive:

- Minimum microprocessor: Intel Pentium I 133 MHz
- Minimum RAM: 32 MB
- Windows 98, Windows 95, or Windows NT 4.0 operating system if you will be adding an MPEG-2 adapter (not included)
- Windows 98, Windows 95, Windows NT 4.0, Windows 3.x, OS/2, or DOS operating system if you are going to use the drive as a *data-only* DVD-ROM drive or as a CD-ROM drive in DOS mode
- Available drive bay
- 3.5-inch diskette drive to load the included device drivers if you are going to use the drive as a *data-only* DVD-ROM drive or as a CD-ROM drive in DOS mode
- Available IDE connection
- 1 MB available hard disk drive space

¹ MB equals approximately 1 000 000 bytes.

Before you begin

Before you install the DVD-ROM drive, read the information in this section on handling precautions and on using the drive controls and connectors.

Handling precautions

Use the following handling precautions to protect your drive.

Keep the DVD-ROM drive in the antistatic bag until you are ready to install it. Limit your movement when installing; movement can cause static electricity buildup.

Handle the drive with care. Dropping or jarring the drive can damage the components inside the drive housing.

Do not force insertion of the power cable. Doing so might damage the connector or the drive.

Drive controls and connectors

The following diagrams show the location and functions of the drive controls and connectors.

Front view of the drive

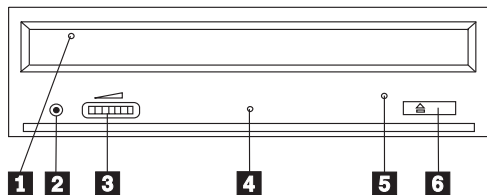

1 Disc drawer

This drawer is where you load and unload a disc.

2 Headphone jack

This jack provides audio output to the headphones.

3 Volume control

This dial controls the headphone volume.

4 Busy indicator

This light comes on when the drive reads from, writes to, or plays a disc.

5 Emergency eject hole

This hole provides access to the eject mechanism to remove a disc from the drive.

6 Open/Close button

This button opens and closes the disc drawer when you push it.

Rear view of the drive

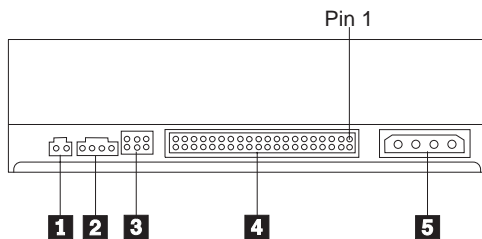

1 **Reserved**

2 **Audio-out connector**

This port connects the analog audio signals to an audio adapter.

3 **Configuration pins**

These pins are used to set the drive configuration.

4 **IDE port**

This connects the DVD-ROM drive to the IDE cable.

5 **Power connector**

This connects the power cord to the DVD-ROM drive.

Installing the drive

Use the following steps to install the drive.

Step 1. Opening the computer

1. Turn off the computer and all attached devices.
2. Unplug the power cords for the computer and all attached devices.
3. Remove the cover from the computer.

Step 2. Unpacking the drive

1. Take the bag the drive is packed in and touch it to an unpainted metal surface for at least two seconds. This will drain the static electricity from the package and your body.
2. Remove the drive from the bag.

If you must put the drive down, place the antistatic bag on a flat, padded surface, such as a magazine, and place the drive on the bag.

Step 3. Setting the configuration jumpers

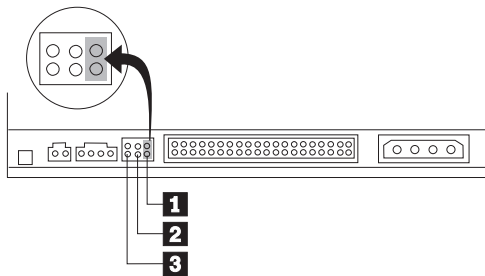

You can configure your drive as master 1, slave 2, or cable-select 3, as shown.

Use the following guidelines to determine the correct configuration for your DVD-ROM drive.

Configure the DVD-ROM drive as a master if it will be the only device connected to an IDE cable. (This is the preset configuration.)

Configure the DVD-ROM drive as a slave if it will be the second device on an IDE cable. Be sure to configure the other device as a master. In some cases, a hard disk drive might require a Master with Slave Present jumper setting when another device on the same cable is configured as a slave. For more information on setting configuration jumpers on other devices, refer to the documentation that comes with your computer system or with the device.

Some non-IBM computers use special ATA cables with two wires reversed in the device connectors so that the drives can be configured by the cable instead of by jumper position. Use the cable-select position only for computers equipped with these special cables. See the documentation that comes with your computer to determine if your ATA adapter requires that you place the jumpers in the cable-select position.

If you place the jumpers in the cable-select position, the IDE cable automatically assigns the master and slave settings based on the position of the drive on the cable. You must use the cable-select setting for this cabling system whether the DVD-ROM drive is the only device or the second device connected to the cable. The drive closest to the IDE controller is automatically the master drive. Any other devices on the IDE cable must also be set to cable-select.

Step 4. Mounting the drive in the bay

Attention: Be sure to use the M3 x 5 mm mounting screws in the option package when you are driving screws directly into the drive. Using screws that are too long might damage the drive.

You can mount the DVD-ROM drive horizontally or vertically in the computer. If you mount the drive vertically, you must secure any discs you place into the drive before the drive tray is closed, or the DVD-ROM drive will not be able to read the disc properly. For more information on securing discs in a vertically mounted drive, go to page “Securing a disc in a vertically mounted drive” on page 2-3.

1. Slide the drive into the bay. Your computer might have specific required procedures for installing storage devices. For more information on storage devices, refer to the documentation that comes with your computer.
2. Align the drive-bay screw holes with the threaded holes in the drive housing or mounting bracket.
3. Thread the screws in loosely to check their position. Usually two screws are used on each side. Verify that the alignment is correct; then tighten the screws to secure the drive. *Do not overtighten.*

Step 5. Attaching the cables to the drive

The following diagram shows where to connect the cables to the drive.

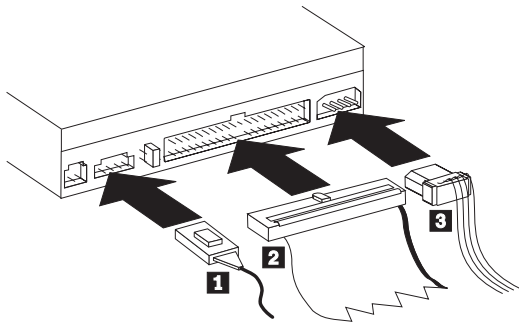

1. Connect the larger end of the included internal audio cable 1 to the audio-out connector on the DVD-ROM drive. The following is an illustration of an internal audio cable.

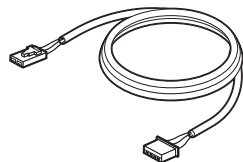

2. Attach a 40-pin IDE-cable connector 2 to the IDE connector on the drive. Align the cable so that the color-coded edge is closest to the power cable connector 3. Use the IDE cable provided with this option if there is no cable attached to the IDE port. The IDE cable can have up to three connectors. For the best signal quality when you are connecting only one device to the IDE cable, attach the connector on one end of the cable to the IDE port and the connector on the other end of the cable to the device. Do not use the middle connector. Use the IDE cable provided with this option if there is no cable attached to the computer IDE port, or if there is only one device connector on the computer IDE cable.

If you are connecting two devices to the IDE cable, attach the connector on one end of the cable and the remaining cable connectors to the master and slave devices. Many computers have two cables for attaching up to four ATA devices. For best performance, attach fast devices (hard disk drives) to the cable connected to the primary IDE port, and the DVD-ROM drive or other slower devices (CD-ROM drives, tape drives, removable media) to the cable connected to the secondary IDE port.

3. Attach a four-pin power cord 3 to the power connector on the DVD-ROM drive.

If you have an audio adapter, connect one of the included audio cables 1 to the device audio-out connector. Use the audio cable that has a connector that fits your audio adapter. Keep the other cable in case you use a different audio adapter in the future.

Be sure that the cables will not be pinched or crowded by the computer cover and that all other cable and power connections are secure.

Note: *If you are installing the 8Xmax DVD-ROM Drive that does not come with the WinDVD MPEG-2 software and would like to play MPEG-2 video files in Windows 98, Windows 95, or Windows NT 4.0, you must install an MPEG-2 adapter such as IBM part number 33L5009 (not included) using the instructions that come with the adapter.*

Step 6. Completing the hardware installation

1. Be sure that the DVD-ROM drive is securely mounted and the connectors are firmly attached.
2. Be sure that the cables do not interfere with the computer cover and do not block the power-supply fan blades or air-flow paths.
3. Reinstall the computer cover.
4. Reconnect all external devices.
5. Plug all power cords into electrical outlets.

Step 7. Attaching the faceplates

This option package includes two faceplates that conform to the curved design of certain computers. If your computer has a curved design, you can attach one of the included faceplates so that the front of the drive matches the exterior cabinet. Choose the faceplate that best fits your computer, and attach it after you have mounted the DVD-ROM drive in the appropriate bay.

Step 8. Updating your computer configuration

After you have completed the hardware installation, restart your computer. When you turn on your computer, the configuration-setup information screen is displayed on your screen. If you do not see this screen, check your computer documentation for information about accessing the configuration or setup utility program.

To see the configuration information for most IBM computers, press F1 during startup when the graphic displays in the upper-right corner of the screen. After you have reviewed the information, save the changes and exit.

Step 9. Installing the device drivers

Note: If you do not plan to access the DVD-ROM drive through a DOS session, go directly to Step 11.

This section contains the instructions for installing device drivers for the DVD-ROM drive.

Note: Be sure to read the README.TXT file for additional information about the device drivers.

In most instances, Windows 98, Windows 95, and Windows NT 4.0 will automatically detect the DVD-ROM drive and will already have the necessary device drivers. However, you cannot use the standard Windows 98, Windows 95, or Windows NT 4.0 device drivers to access the DVD-ROM drive through a DOS session.

If you are using the DVD-ROM drive with DOS, Windows 3.x, or OS/2, or if you want to access the DVD-ROM drive through a DOS session in Windows 98, Windows 95, or Windows NT 4.0, you must install the DOS device driver from the *8Xmax DVD-ROM Drive Option Diskette*. This device driver will allow you to access the DVD-ROM drive in DOS, or to access the DVD-ROM drive through an open DOS session in Windows 3.x, OS/2, Windows 98, Windows 95, or Windows NT 4.0.

Note: In DOS mode, the DVD-ROM drive functions as a *data-only* DVD-ROM drive or as a CD-ROM drive, and can only read data discs.

Follow these instructions to install the device driver.

1. Insert the *8Xmax DVD-ROM Drive Option Diskette* into the diskette drive.
2. Type `A:CDSETUP` in a command line and press Enter.
3. Click **Setup**.
4. Follow the on-screen instructions to install the software.
5. Click **Exit** when software installation completes.
6. Restart your computer so that the new settings take effect.

Some IBM computers with preinstalled Windows NT 4.0 contain a PIIXIDE device driver. This device driver replaces the Windows NT 4.0 native ATAPI device driver, and provides DMA support. The drive will *not* work if both the ATAPI and PIIXIDE device drivers are enabled at the same time. If both device drivers are enabled at the same time, go into the Control Panel and set the Startup parameter of one of the device drivers to **Disabled**.

For optional information about configuring the *8Xmax DVD-ROM Drive Option Diskette* device drivers for Windows 3.x, DOS, OS/2, Windows 98, and Windows 95, go to Appendix A, “Customizing device-driver configuration settings” on page 3-1.

Step 10. Using the DVD-ROM drive with data CDs and data DVDs

You can use the DVD-ROM drive to read data CDs and data DVDs.

To read a data disc:

1. Turn on the computer.
2. Load a data disc into the loading tray.
3. Wait for the DVD-ROM drive LED to stop lighting; then double-click **My Computer**.
4. Verify that the **CD-ROM** icon is displayed.
5. Double-click the **CD-ROM** icon.
6. Verify that you can view the disc files on the displayed list.

Step 11. What to do next

If you will be using the drive as a *data-only* DVD-ROM drive or as a CD-ROM drive, you have completed the installation. For information on maintaining your drive, see “Part 2: Care and maintenance guide” on page 2-1.

If you will be installing the *WinDVD* software for Windows 98 or Windows 95 OSR2, continue with Step 12.

If you will be installing the *WinDVD* software for Windows NT 4.0, go to “Step 14. Software verification for Windows NT 4.0” on page 1-12.

Step 12. Enabling DMA in Windows 98 or Windows 95 OSR2

Before you install the *WinDVD* software, be sure that the Direct Memory Access of your DVD-ROM drive has been enabled in Windows 98 or Windows 95 OSR2 or the video and audio playback quality might be poor.

To enable DMA for Windows 98 or Windows 95 OSR2:

1. Double-click **My Computer**.
2. Double-click **Control Panel**.
3. Double-click **System**.
4. Click the **Device Manager** tab.
5. Double-click **CDROM**.
6. Select the DVD-ROM device in the menu display.
7. Click **Properties**.
8. Click the **Settings** tab to view the DMA option in the Options window.
9. Place a check in the DMA check box to enable DMA.
10. Click **OK**.
11. Click **OK**.
12. Click **Close**.
13. Restart your computer to enable the DMA mode of your DVD-ROM drive.

Step 13. Installing the WinDVD software for Windows 98 or Windows 95 OSR2

Note: Before installing *WinDVD*, be sure to read “Changing the DVD region code” on page 1-14 to familiarize yourself with the region code concept.

To install the *WinDVD* software for Windows 98 or Windows 95 OSR2:

1. Close any programs running on the desktop.
2. Insert the *WinDVD* software CD into your DVD-ROM drive.
3. If the Installation window opens, go to step 8 below.
4. Click **Start**.
5. Select **Run**.
6. Type `x:\setup.exe` where *x* is the drive letter for your DVD-ROM drive.
7. Click **OK**.
8. Follow the on-screen instructions to complete the installation.
Note: During installation, *WinDVD* verifies that you have the most recent versions of DirectX and DirectMedia. If *WinDVD* does not find the most recent version, click **Yes** when *WinDVD* prompts you to install DirectX 6.1 or DirectMedia.
9. Restart Windows.

You have completed the installation of the *WinDVD* software for Windows 98 or Windows 95 OSR2. For information on using *WinDVD*, go to “Using the DVD software” on page 1-14.

Step 14. Software verification for Windows NT 4.0

If you are using Windows NT 4.0, refer to the documentation that comes with your computer to determine if the IDE controller on your computer supports DMA transfers.

Note: Be sure that your computer has an Intel chipset and that you are using the Service Pack 3 or the latest Service Pack for Windows NT provided by Microsoft. Refer to the documentation that comes with your computer to determine if there is an Intel chipset in your computer. For more information on installing Windows NT Service Packs, visit the Microsoft Web site at <http://microsoft.com>

If your computer IDE controller supports DMA transfers, continue with “Step 15. Installing the WinDVD software for Windows NT 4.0.”

If your computer IDE controller does not support DMA transfers, you must go to the Web site for the system board manufacturer and install the Windows NT 4.0 DMA device driver using instructions provided on the Web site.

The following is a list of manufacturer Web sites that contain Windows NT 4.0 DMA device drivers for system boards:

IBM: <http://www.ibm.com>
Intel: <http://www.intel.com>
VIA: <http://via.com.tw>
ALi: <http://ali.com.tw>

Refer to the documentation that came with your computer for information on other system board manufacturers.

Step 15. Installing the WinDVD software for Windows NT 4.0

Note: Before installing *WinDVD*, be sure to read “Changing the DVD region code” on page 1-14 to familiarize yourself with the region code concept.

To install the *WinDVD* software for Windows NT 4.0:

1. Start Windows.
2. Insert the *WinDVD* software CD into your DVD-ROM drive.
3. If the Installation window opens, go to step 4 below. If the installation window does not open, double-click **My Computer**, double-click the **CD-ROM** icon, and click the **Setup** icon.
4. Follow the on-screen instructions to complete the installation.
5. Restart Windows.
6. Use instructions given in Step 16 to enable DMA in Windows NT 4.0 or the video and audio playback might be poor.

Step 16. Enabling DMA for Windows NT 4.0

Attention: Before enabling DMA for Windows NT 4.0, be sure to read “Step 14. Software verification for Windows NT 4.0” on page 1-12 to determine if your computer can perform this upgrade procedure. If you do not perform this procedure correctly, your operating system might lock up. Therefore, be sure to build an Emergency Repair Disk before you use the following upgrade instructions. If you are not familiar with the procedure for building an Emergency Repair Disk, press F1 to obtain instructions from the Microsoft NT online help.

To enable DMA in Windows NT 4.0:

1. Log on as an Administrator.
2. Disable the CD-ROM device driver using the following instructions.
 - a. Double-click **My Computer**.
 - b. Double-click **Control Panel**.
 - c. Double-click **Devices**.
 - d. Select the **ATAPI** device.
 - e. Click **Startup**.
 - f. Click **Disabled**; then click **OK**. Disregard displayed warnings.
 - g. Select the **PIIXIDE** device.
 - h. Click **Startup**.
 - i. Click **Disabled**; then click **OK**. Disregard displayed warnings.
3. Upgrade the CD-ROM device driver using the following instructions.
 - a. Double-click **My Computer**.
 - b. Double-click **Control Panel**.
 - c. Double-click **SCSI adapters**.
 - d. Click the **Drivers** tab.
 - e. Select the **IDE CDROM** device driver; then click **Remove** and **Yes**.
 - f. Click **Add**.
 - g. Browse to the **\PIIXIDE** directory created during the installation of *WinDVD* in Step 15.
 - h. Select the **PIIXIDE** device driver and click **Open**.
 - i. Click **OK**.

The SCSI adapter will now be identified as **Intel PIIX PCI Bus Master IDE Controller**.
 - j. Click **OK**.
 - k. Select **Yes** to restart your computer.

Using the DVD software

This section describes how to use and customize the *WinDVD* software. You can find additional information on *WinDVD* in the README file on the *WinDVD* software CD.

Changing the DVD region code

Attention: Regionalization and Copy Protection (the DVD region code) uses the Content Scramble System (CSS) standard to prevent unauthorized duplication of the intellectual property rights distributed on DVDs. It was originally requested by the Motion Picture Association of America (MPAA) to address video piracy but is applicable to any content. CSS works by inhibiting the transmission of unencrypted data from the PCI bus. Playback systems must license CSS to decode the encrypted data.

The CSS specification divides the world into six unique regions. Content designated for one region cannot be read by playback systems in another region. While CSS is used to prevent digital copies of the DVD content, another technology devised by Macrovision is used to prevent analog copies of the DVD content. The Macrovision standard is a scrambling system that has been widely used by the movie industry to prevent unauthorized duplication of video content using commercial VCRs. DVD playback systems must support both CSS and Macrovision copy protection standards.

If you relocate to a different region of the world, you can use the *WinDVD* software to change the region code.

Note: You can change the DVD region code only five times. After you make five region code changes, the drive can play only MPEG-2 video titles that are associated with the fifth region code that you set.

To change the region code:

1. Turn on your computer and start your operating system.
2. Click **Start**.
3. Select **Programs**.
4. Select **Intervideo WinDVD**. (If you have created a shortcut to *WinDVD* on your desktop, you can click it instead.)
5. Click  to open the Properties window.
6. Click the **General Properties** tab.
7. Select the correct region code for your country.
8. Click **OK** so that changes take effect.

Starting the WinDVD software

When you insert a DVD into the DVD-ROM drive, the *WinDVD* software automatically detects the format of a disc and begins playing it.

To start the *WinDVD* software:

1. Turn on your computer and start your operating system.
2. Click **Start**.
3. Select **Programs**.
4. Select **Intervideo WinDVD**. (If you have created a shortcut to *WinDVD* on your desktop, you can click it instead.)
5. Make your selections from the menu within the *WinDVD* window, or click

 on the control panel.

Using the WinDVD display panel controls

This section contains information on using the controls in the *WinDVD* display panel. Refer to the following illustration for the location of the controls. For more information on the controls, press F1 to view online information.



The *WinDVD* controls are designed to look like controls on a stand-alone DVD player. Options not available on a specific DVD will be inaccessible.

Using the Start/Eject controls

This section provides information on using the *WinDVD* Start/Eject controls.



Click this button to close *WinDVD*.



Click this button to open the Playlist window so that you can select a specific order and group of files. You cannot select a file while a movie is playing. For more information on creating a playlist, go to “Creating a playlist” on page 1-20.













Click this button to open the Properties window. For more information on customizing properties in *WinDVD*, see “Customizing WinDVD properties” on page 1-20.



Click this button to eject a DVD from the DVD-ROM drive.





Using the directional controls

This section provides information on using the *WinDVD* directional controls.

-  Click this button to stop playing a DVD.
-  Click this button to start playing a DVD.
-  Click this button to pause playing a DVD.
-  Click this button to advance a single frame while the DVD is in Pause mode.
-  Click this button to replay the DVD or the current DVD chapter.
-  Click this button to go to the previous chapter.
-  Click this button to go to the next chapter.
-  Click this button to play the DVD in Fast Reverse mode.
-  Click this button to play the DVD in Fast Forward mode.
-  Click this button to restart the same chapter.

Using the sliders

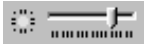
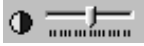
This section provides information on using the *WinDVD* sliders.

-  Move this slider to view a specific time in the DVD.
-  Move this slider to make Slow Motion and Fast Forward smoother.
-  Move this slider to increase or decrease the volume.
-  Move this slider to increase or decrease the video brightness.
-  Move this Color Control Bar slider to adjust the balance of the blue and yellow colors in the video.
-  Move this Color Control Bar slider to adjust the balance of the red and green colors in the video.

Using the counter

The following illustration shows the counter from the display panel. The counter displays the chapter being played and the elapsed time since the DVD began playing.



Using the directional arrows

The following illustration shows the directional arrows on the display panel.

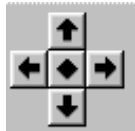

Use the buttons like a mouse button or Tab key. The arrows on the buttons represent (clockwise from the top): navigate up, navigate right, navigate down, and navigate left. You can click the center button to select or enter an option.

Using the numeric keypad

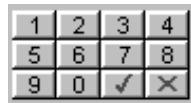

Video CDs, when played, commonly require you to select numbers. To enter a numeric value, click the corresponding key on the numeric keypad; then click the green check mark to accept that number.

Using the menu buttons

This section contains information on using the MENU, TITLE, CHAPTER, AUDIO, SUBTITLE, and ANGLE menu buttons. To enable a menu function, click the menu button. The following table shows the function of each menu button.

Menu button	Function
MENU	Displays the available menus (such as Audio Language or Subtitles) on the DVD you are playing
TITLE	Opens a submenu displaying the available titles on the DVD you are playing
CHAPTER	Displays the chapter that is being played or selects another chapter
AUDIO	Displays the audio track options on the DVD you are playing (can select another track or language if multiple audio tracks or languages are available on the disc)
SUBTITLE	Displays the subtitle menu (can select another language if multiple language subtitles are available on the DVD)
ANGLE	Selects a viewing angle if your DVD has this option

Using the right-click menu

When you are viewing a DVD movie, you can display a video pull-down menu by placing the cursor on the display window and right-clicking. To enable a DVD play function, click the desired menu selection. The following table shows the menu selections and functions.

Menu selection	Function
Play	Starts playing the current title after a pause
Stop	Stops the current playback
Pause	Pauses the current playback
Fast Forward	Plays the disc in Fast Forward mode
Fast Backward	Plays the disc in Fast Reverse mode
Previous Chapter	Jumps to the previous chapter
Next Chapter	Jumps to the next chapter
Repeat	Repeats the disc play
Mute	Mutes the sound on the disc
Eject	Ejects the disc from the drive
Menu	Displays menu selections
Title	Displays title information

Menu selection	Function
Chapter	Displays chapter selections
Subtitle	Displays subtitle selections
Audio	Displays audio track
Angle	Displays angle selections
Playlist	Displays playlist selection
Properties	Opens the Properties window
Adjustment	Opens the Audio/Video adjustment window
View	Displays tool bar, status bar, and player
About	Displays version and copyright information
Exit	Closes <i>WinDVD</i>

Using the Status Bar

When you view a DVD and select Show Status Bar from the Properties menu, *WinDVD* displays the Status Bar across the bottom of the screen, as shown in the following illustration.

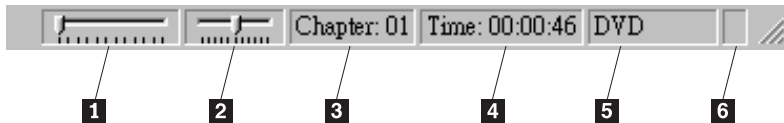

You can use the following controls in the Status Bar:

- 1 Use this slider to move to a different time in the disc.
- 2 Use this slider to make Slow Motion or Fast Forward smoother.
- 3 This displays the current chapter.
- 4 This displays the elapsed time.
- 5 This displays the disc type.
- 6 If continuous loop has been enabled, this icon displays in the far right of the status bar.

Using the adjustment and help buttons

This section provides information on using the adjustment and help buttons that display above the video screen.



Click this button to open the Audio and Video adjustment window.



Click this button to open the online help.

Creating a playlist

To create a playlist:

1. Insert a DVD into the DVD-ROM drive.
2. Click  to open the Playlist window.
3. Click **File**.
4. Select the first file to be played from the correct drive and directory. You can play .mpg, .vob, and .ac3 files.
5. Click **Add**.
6. Repeat this procedure with as many files as you want.

Remember that these files will now play in the order in which they appear. If you would like to change the order, delete and replace files.

7. Click **Save** to save your playlist for future use.
8. Click **Play** to automatically play the files in the order specified.

Loading a previously saved playlist

To load a previously saved playlist:

1. Insert a DVD into the DVD-ROM drive.
2. Click  to open the Playlist window.
3. Click **Load Playlist** to display the list of saved playlists.
4. Click **Play** to automatically play the files in the order specified.

Customizing WinDVD properties

This section contains information on customizing properties in *WinDVD*. You can customize the following properties: General, Audio, Display, and Parental Control.

General Properties

You can use the General Properties to select the drive letter for the DVD-ROM drive, to enable autostart when a disc is inserted into the DVD-ROM drive, and to hide or display the control panel.

To change features in General Properties:

1. Start *WinDVD*.
2. Click  to open the Properties window.
3. Click the **General** tab.

4. Customize the properties as desired.

Select **Default DVD Drive** to assign a drive letter for your DVD-ROM drive.

Place a check in the **Autoplay** check box if you want *WinDVD* to automatically start when you insert a DVD into the DVD-ROM drive.

Place a check in the **View Toolbar** check box to display the toolbar at the top of the video window, or remove the check from the **View Toolbar** check box to hide the toolbar.

Place a check in the **Statusbar** check box to display the status bar at the bottom of the video window, or remove the check from the **Statusbar** check box to hide the status bar.

5. Click **OK** so that the changes take effect.

Audio Properties

You can use the **Audio Properties** tab to customize audio output. To customize audio output in Audio Properties:

1. Start *WinDVD*.
2. Click  to open the Properties window.
3. Click the **Audio Properties** tab.
4. Customize the properties as desired.

Note: Your audio card might not have some audio output features. Be sure to check the documentation that comes with your audio card before you enable an audio output feature.

If you want to mix the two channels into one, place a check in the **Mono** check box

If you want to mix all audio channels on the disc down to two channels, place a check in the **Stereo** check box

If you want to receive two-channel audio output that includes Dolby Pro Logic Surround sound, place a check in the **Dolby Surround** check box

If you want to receive 3-D audio output, place a check in the **3-D Audio** check box

You might also be able to use the following audio output options:

- **4-Speaker Mode:** If your computer uses four speakers, this option is available. When you select this option, *WinDVD* automatically distributes four unique sound channels to these speakers, providing a true surround experience.

- **6-Speaker Mode:** If your computer uses six speakers, this option will be available. When you select this option, *WinDVD* automatically distributes 5.1 sound channels to these speakers.
 - **Enable S/PDIF output:** When you select this option, *WinDVD* sends the stereo output through an S/PDIF-compliant audio adapter to an external receiver.
 - **Current Audio Track:** When you select this option, *WinDVD* displays the current audio track format or audio track attributes.
5. Click **OK** so that the changes take effect.

Vocal options

You can also customize vocal options in Audio Properties if you are playing karaoke or vocal-type discs. To customize vocal output in Audio Properties:

1. Start *WinDVD*.
2. Click  to open the Properties window.
3. Click the **Audio Properties** tab.
4. Select one of the following vocal output options:
 - No vocal:** Vocals are not output to any speaker.
 - Left vocal:** Vocals are output only to left speakers.
 - Right vocal:** Vocals are output only to right speakers.
 - Both:** Vocals are output to both sides.
5. Click **OK** so that the changes take effect.

Display Properties

You can use the Display Properties tab to customize the display of the DVD output.

To customize display output in Display Properties:

1. Start *WinDVD*.
2. Click  to open the Properties window.
3. Click the **Display Properties** tab.
4. Enable one of the following quality settings:
 - Low:** Select this option to disable all features displayed in the Custom Quality settings section.
 - High:** Select this option to enable all features displayed in the Custom Quality settings section.
 - Custom:** Select this option to customize the following settings in the Custom Quality section:

- **Smooth horizontal scaling:** When you select this option, *WinDVD* displays a smoother video picture when the display window is horizontally resized on graphics adapters that do not provide for hardware scaling (enabling this feature might use extra CPU bandwidth).
- **Smooth vertical scaling:** When you select this option, *WinDVD* displays a smoother video picture when the display window is vertically resized on graphics adapters that do not provide hardware scaling (enabling this feature might use some CPU bandwidth).
- **Software Bob (de-interlacing):** When you select this option, *WinDVD* controls video “jitter” for interlaced video content (30fps), enhancing the smoothness and sharpness of the picture.

5. You can also select the following display options:

Place a check in the **Hardware Motion Compensation** check box to use the hardware motion compensation provided by your VGA card.

Place a check in the **Lock Aspect Ratio** check box to display the correct ratio when you resize the video window. The screen can then only be resized in the same dimensions as the disc format. If you do not check **Lock Aspect Ratio**, the picture might be distorted when you resize the window.

Place a check in the **Startup in full screen mode** check box to automatically open the *WinDVD* window in full-screen mode whenever you start *WinDVD*.

6. Click **OK** so that the changes take effect.

Parental Control Properties

You can use the **Parental Control** tab to set the parental controls to be sure that only age-appropriate movies and titles can be viewed. (In some cases, movies can be shown in modified form to allow different ratings for the same movie.) To set movie-rating limits in *WinDVD*:

1. Start *WinDVD*.
2. Click  to open the Properties window.
3. Click the **Parental Control** tab.
4. Select the desired age-appropriate level so that no one can view titles with movie ratings higher than the one selected. You can select one of the following levels.
 - G: Suitable for general audiences
 - PG: Parental guidance suggested
 - PG-13: Parental guidance suggested, not suitable for children under 13
 - R: Restricted
 - NC-17: Adult theme or content, not suitable for children under 17

You can change the level at any time.

5. If you have set a password, enter the password now; then click **OK**. You can change your password at any time. For information on setting and changing passwords, see “Setting and changing the parental control password” on page 1-24.
6. Click **OK** so that the changes take effect.

Setting and changing the parental control password

To set a parental control password:

1. Click **Set Password** in the Parental Control window.
2. Type your desired password in the **New Password** box.
3. Type the same password again in the **Confirm New Password** box.

Be sure to type the same password twice, or the *WinDVD* program will not accept it.

4. Click **OK** to accept the password.

To change a parental control password:

1. Type your current password in the **Old Password** box.
2. Click **Set Password** in the Parental Control window.
3. Type the new password in the **New Password** box.
4. Type the new password again in the **Confirm New Password** box.

Be sure to type the same new password twice, or the *WinDVD* program will not accept it.

5. Click **OK** to accept the new password.

Playing an interactive DVD

You do not need to perform additional procedures to play interactive DVD or MPEG-2 video-based discs. When you insert an interactive disc, *WinDVD* will play the DVD or MPEG-2 video files on the disc.

Closing WinDVD

To close *WinDVD*:

1. Stop playing any DVD in the DVD-ROM drive.
2. Click  in the *WinDVD* display panel.

Installation and user's guide (Translate)

This section contains the product description, hardware and software installation instructions, and operating information.

Product description

You have received one of the following option packages:

IBM 8Xmax Internal IDE DVD-ROM Drive with Software MPEG-2

This drive comes with a software CD containing an MPEG-2 decoder for Microsoft Windows 98, Windows 95 OSR2, and Microsoft Windows NT 4.0 Workstation.

In addition to this book, the option package includes:

- IBM 8Xmax DVD-ROM Drive
- Four mounting screws (M3 x 5 mm, slotted)
- IDE cable for connecting two IDE devices
- Two white faceplates for use with certain computers
- Two internal audio cables
- WinDVD* MPEG-2 software CD
- 8Xmax DVD-ROM Drive Option Diskette*
- Safety information manual
- Laser Safety Guide*

IBM 8Xmax Black Internal IDE DVD-ROM Drive

You can use this drive to play MPEG-2 DVD video files in Windows 98, Windows 95, or Windows NT 4.0 only if you install an MPEG-2 adapter (not included) in your computer. However, you do not need to install an MPEG-2 adapter to use the drive as a *data-only* DVD-ROM drive or as a CD-ROM drive.

In addition to this book, the option package includes:

- IBM 8Xmax DVD-ROM Drive
- Four mounting screws (M3 x 5 mm, slotted)
- IDE cable for connecting two IDE devices
- One black faceplate
- Two internal audio cables
- 8Xmax DVD-ROM Drive Option Diskette*
- Safety information manual
- Laser Safety Guide*

Your drive can read many DVD and CD formats, including DVD video, Video CD, and audio CD formats. However, you must install a video decoder to read video files. The drive also reads multiple-session, extended architecture (XA) discs, such as the Kodak Photo CD. When used as a CD-ROM drive, this drive delivers data at up to 40 times the standard CD-ROM speed (40X). The DVD-ROM drive is designed for installation in a personal computer that uses the integrated drive electronics (IDE) or enhanced IDE (EIDE) architecture.

Contact your place of purchase if an item is missing or damaged. Be sure to retain your proof of purchase. It might be required to receive warranty service. See Appendix C, "Help and service information" on page 3-13 for technical support information.

Software description

The IBM 8Xmax Internal IDE DVD-ROM Drive with Software MPEG-2 option kit includes the following software:

WinDVD MPEG-2 software CD

With the *WinDVD* software, you do not need to install an MPEG-2 adapter in your computer to view DVD video files. The *WinDVD* software CD contains an MPEG-2 decoder and programs that work with Windows 98, Windows 95 OSR2, and Windows NT 4.0. You can use the software to play high-resolution DVD movies or MPEG-2 files with MPEG-2 video and Dolby AC-3 audio on a multimedia computer.

8Xmax DVD-ROM Drive Option Diskette

The *8Xmax DVD-ROM Drive Option Diskette* contains device drivers for Windows 98, Windows 95, Windows NT 4.0, Windows 3.x, IBM OS/2, and DOS that you can use to access the drive as a *data-only* DVD-ROM drive or as a CD-ROM drive in DOS mode. The diskette also includes an audio CD-player program for DOS and a diagnostic program.

The IBM 8Xmax Black Internal IDE DVD-ROM Drive option kit includes the following software:

8Xmax DVD-ROM Drive Option Diskette

The *8Xmax DVD-ROM Drive Option Diskette* contains device drivers for Windows 98, Windows 95, Windows NT 4.0, Windows 3.x, OS/2, and DOS that you can use to access the drive as a *data-only* DVD-ROM drive or as a CD-ROM drive in DOS mode. The diskette also includes an audio CD-player program for DOS and a diagnostic program.

Installation requirements

If you received the IBM 8Xmax Internal IDE DVD-ROM Drive with Software MPEG-2, be sure that your computer meets the following system requirements before installing the drive:

- Minimum microprocessor: Intel Pentium II 333 MHz
- Minimum RAM: 32 MB
- Windows 98, Windows 95 OSR2, or Windows NT 4.0 operating system if you will be using the *WinDVD* MPEG-2 software CD
- Windows 98, Windows 95, Windows NT 4.0, Windows 3.x, OS/2, or DOS operating system if you are going to use the drive as a *data-only* DVD-ROM drive or as a CD-ROM drive in DOS mode
- Available drive bay
- 3.5-inch diskette drive to load the included device drivers if you are going to use the drive as a *data-only* DVD-ROM drive or as a CD-ROM drive in DOS mode
- Available IDE connection
- 20 MB² available hard disk drive space
- Audio adapter supporting 44.1 or 48 KHz sampling rate
- Optional stereo speakers

If you received the IBM 8Xmax Black Internal IDE DVD-ROM Drive, be sure that your computer meets the following system requirements before installing the drive:

- Minimum microprocessor: Intel Pentium I 133 MHz
- Minimum RAM: 32 MB
- Windows 98, Windows 95, or Windows NT 4.0 operating system if you will be adding an MPEG-2 adapter (not included)
- Windows 98, Windows 95, Windows NT 4.0, Windows 3.x, OS/2, or DOS operating system if you are going to use the drive as a *data-only* DVD-ROM drive or as a CD-ROM drive in DOS mode
- Available drive bay
- 3.5-inch diskette drive to load the included device drivers if you are going to use the drive as a *data-only* DVD-ROM drive or as a CD-ROM drive in DOS mode
- Available IDE connection
- 1 MB available hard disk drive space

² MB equals approximately 1 000 000 bytes.

Before you begin

Before you install the DVD-ROM drive, read the information in this section on handling precautions and on using the drive controls and connectors.

Handling precautions

Use the following handling precautions to protect your drive.

Keep the DVD-ROM drive in the antistatic bag until you are ready to install it. Limit your movement when installing; movement can cause static electricity buildup.

Handle the drive with care. Dropping or jarring the drive can damage the components inside the drive housing.

Do not force insertion of the power cable. Doing so might damage the connector or the drive.

Drive controls and connectors

The following diagrams show the location and functions of the drive controls and connectors.

Front view of the drive

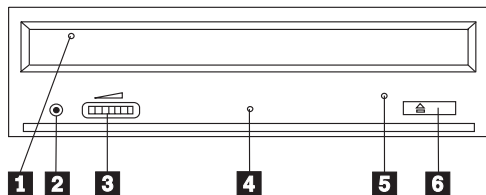

1 Disc drawer

This drawer is where you load and unload a disc.

2 Headphone jack

This jack provides audio output to the headphones.

3 Volume control

This dial controls the headphone volume.

4 Busy indicator

This light comes on when the drive reads from, writes to, or plays a disc.

5 Emergency eject hole

This hole provides access to the eject mechanism to remove a disc from the drive.

6 Open/Close button

This button opens and closes the disc drawer when you push it.

Rear view of the drive

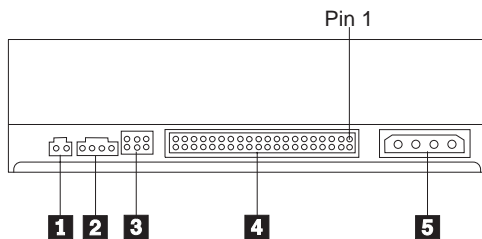

1 **Reserved**

2 **Audio-out connector**

This port connects the analog audio signals to an audio adapter.

3 **Configuration pins**

These pins are used to set the drive configuration.

4 **IDE port**

This connects the DVD-ROM drive to the IDE cable.

5 **Power connector**

This connects the power cord to the DVD-ROM drive.

Installing the drive

Use the following steps to install the drive.

Step 1. Opening the computer

1. Turn off the computer and all attached devices.
2. Unplug the power cords for the computer and all attached devices.
3. Remove the cover from the computer.

Step 2. Unpacking the drive

1. Take the bag the drive is packed in and touch it to an unpainted metal surface for at least two seconds. This will drain the static electricity from the package and your body.
2. Remove the drive from the bag.

If you must put the drive down, place the antistatic bag on a flat, padded surface, such as a magazine, and place the drive on the bag.

Step 3. Setting the configuration jumpers

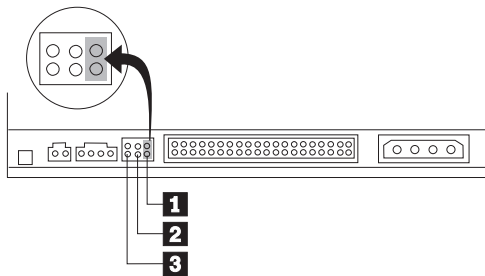

You can configure your drive as master 1, slave 2, or cable-select 3, as shown.

Use the following guidelines to determine the correct configuration for your DVD-ROM drive.

Configure the DVD-ROM drive as a master if it will be the only device connected to an IDE cable. (This is the preset configuration.)

Configure the DVD-ROM drive as a slave if it will be the second device on an IDE cable. Be sure to configure the other device as a master. In some cases, a hard disk drive might require a Master with Slave Present jumper setting when another device on the same cable is configured as a slave. For more information on setting configuration jumpers on other devices, refer to the documentation that comes with your computer system or with the device.

Some non-IBM computers use special ATA cables with two wires reversed in the device connectors so that the drives can be configured by the cable instead of by jumper position. Use the cable-select position only for computers equipped with these special cables. See the documentation that comes with your computer to determine if your ATA adapter requires that you place the jumpers in the cable-select position.

If you place the jumpers in the cable-select position, the IDE cable automatically assigns the master and slave settings based on the position of the drive on the cable. You must use the cable-select setting for this cabling system whether the DVD-ROM drive is the only device or the second device connected to the cable. The drive closest to the IDE controller is automatically the master drive. Any other devices on the IDE cable must also be set to cable-select.

Step 4. Mounting the drive in the bay

Attention: Be sure to use the M3 x 5 mm mounting screws in the option package when you are driving screws directly into the drive. Using screws that are too long might damage the drive.

You can mount the DVD-ROM drive horizontally or vertically in the computer. If you mount the drive vertically, you must secure any discs you place into the drive before the drive tray is closed, or the DVD-ROM drive will not be able to read the disc properly. For more information on securing discs in a vertically mounted drive, go to page “Securing a disc in a vertically mounted drive” on page 2-3.

1. Slide the drive into the bay. Your computer might have specific required procedures for installing storage devices. For more information on storage devices, refer to the documentation that comes with your computer.
2. Align the drive-bay screw holes with the threaded holes in the drive housing or mounting bracket.
3. Thread the screws in loosely to check their position. Usually two screws are used on each side. Verify that the alignment is correct; then tighten the screws to secure the drive. *Do not overtighten.*

Step 5. Attaching the cables to the drive

The following diagram shows where to connect the cables to the drive.

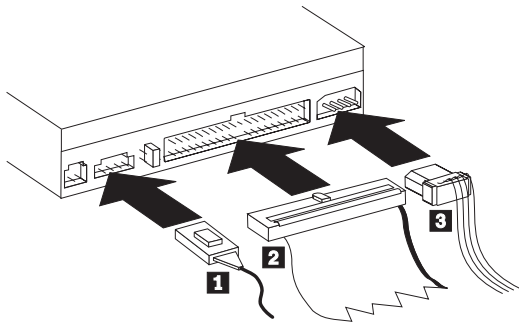

1. Connect the larger end of the included internal audio cable 1 to the audio-out connector on the DVD-ROM drive. The following is an illustration of an internal audio cable.

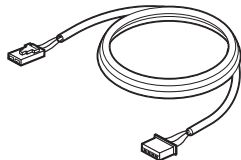

2. Attach a 40-pin IDE-cable connector 2 to the IDE connector on the drive. Align the cable so that the color-coded edge is closest to the power cable connector 3. Use the IDE cable provided with this option if there is no cable attached to the IDE port. The IDE cable can have up to three connectors. For the best signal quality when you are connecting only one device to the IDE cable, attach the connector on one end of the cable to the IDE port and the connector on the other end of the cable to the device. Do not use the middle connector. Use the IDE cable provided with this option if there is no cable attached to the computer IDE port, or if there is only one device connector on the computer IDE cable.

If you are connecting two devices to the IDE cable, attach the connector on one end of the cable and the remaining cable connectors to the master and slave devices. Many computers have two cables for attaching up to four ATA devices. For best performance, attach fast devices (hard disk drives) to the cable connected to the primary IDE port, and the DVD-ROM drive or other slower devices (CD-ROM drives, tape drives, removable media) to the cable connected to the secondary IDE port.

3. Attach a four-pin power cord 3 to the power connector on the DVD-ROM drive.

If you have an audio adapter, connect one of the included audio cables 1 to the device audio-out connector. Use the audio cable that has a connector that fits your audio adapter. Keep the other cable in case you use a different audio adapter in the future.

Be sure that the cables will not be pinched or crowded by the computer cover and that all other cable and power connections are secure.

Note: *If you are installing the 8Xmax DVD-ROM Drive that does not come with the WinDVD MPEG-2 software and would like to play MPEG-2 video files in Windows 98, Windows 95, or Windows NT 4.0, you must install an MPEG-2 adapter such as IBM part number 33L5009 (not included) using the instructions that come with the adapter.*

Step 6. Completing the hardware installation

1. Be sure that the DVD-ROM drive is securely mounted and the connectors are firmly attached.
2. Be sure that the cables do not interfere with the computer cover and do not block the power-supply fan blades or air-flow paths.
3. Reinstall the computer cover.
4. Reconnect all external devices.
5. Plug all power cords into electrical outlets.

Step 7. Attaching the faceplates

This option package includes two faceplates that conform to the curved design of certain computers. If your computer has a curved design, you can attach one of the included faceplates so that the front of the drive matches the exterior cabinet. Choose the faceplate that best fits your computer, and attach it after you have mounted the DVD-ROM drive in the appropriate bay.

Step 8. Updating your computer configuration

After you have completed the hardware installation, restart your computer. When you turn on your computer, the configuration-setup information screen is displayed on your screen. If you do not see this screen, check your computer documentation for information about accessing the configuration or setup utility program.

To see the configuration information for most IBM computers, press F1 during startup when the graphic displays in the upper-right corner of the screen. After you have reviewed the information, save the changes and exit.

Step 9. Installing the device drivers

Note: If you do not plan to access the DVD-ROM drive through a DOS session, go directly to Step 11.

This section contains the instructions for installing device drivers for the DVD-ROM drive.

Note: Be sure to read the README.TXT file for additional information about the device drivers.

In most instances, Windows 98, Windows 95, and Windows NT 4.0 will automatically detect the DVD-ROM drive and will already have the necessary device drivers. However, you cannot use the standard Windows 98, Windows 95, or Windows NT 4.0 device drivers to access the DVD-ROM drive through a DOS session.

If you are using the DVD-ROM drive with DOS, Windows 3.x, or OS/2, or if you want to access the DVD-ROM drive through a DOS session in Windows 98, Windows 95, or Windows NT 4.0, you must install the DOS device driver from the *8Xmax DVD-ROM Drive Option Diskette*. This device driver will allow you to access the DVD-ROM drive in DOS, or to access the DVD-ROM drive through an open DOS session in Windows 3.x, OS/2, Windows 98, Windows 95, or Windows NT 4.0.

Note: In DOS mode, the DVD-ROM drive functions as a *data-only* DVD-ROM drive or as a CD-ROM drive, and can only read data discs.

Follow these instructions to install the device driver.

1. Insert the *8Xmax DVD-ROM Drive Option Diskette* into the diskette drive.
2. Type `A:CDSETUP` in a command line and press Enter.
3. Click **Setup**.
4. Follow the on-screen instructions to install the software.
5. Click **Exit** when software installation completes.
6. Restart your computer so that the new settings take effect.

Some IBM computers with preinstalled Windows NT 4.0 contain a PIIXIDE device driver. This device driver replaces the Windows NT 4.0 native ATAPI device driver, and provides DMA support. The drive will *not* work if both the ATAPI and PIIXIDE device drivers are enabled at the same time. If both device drivers are enabled at the same time, go into the Control Panel and set the Startup parameter of one of the device drivers to **Disabled**.

For optional information about configuring the *8Xmax DVD-ROM Drive Option Diskette* device drivers for Windows 3.x, DOS, OS/2, Windows 98, and Windows 95, go to Appendix A, “Customizing device-driver configuration settings” on page 3-1.

Step 10. Using the DVD-ROM drive with data CDs and data DVDs

You can use the DVD-ROM drive to read data CDs and data DVDs.

To read a data disc:

1. Turn on the computer.
2. Load a data disc into the loading tray.
3. Wait for the DVD-ROM drive LED to stop lighting; then double-click **My Computer**.
4. Verify that the **CD-ROM** icon is displayed.
5. Double-click the **CD-ROM** icon.
6. Verify that you can view the disc files on the displayed list.

Step 11. What to do next

If you will be using the drive as a *data-only* DVD-ROM drive or as a CD-ROM drive, you have completed the installation. For information on maintaining your drive, see “Part 2: Care and maintenance guide” on page 2-1.

If you will be installing the *WinDVD* software for Windows 98 or Windows 95 OSR2, continue with Step 12.

If you will be installing the *WinDVD* software for Windows NT 4.0, go to “Step 14. Software verification for Windows NT 4.0” on page 1-36.

Step 12. Enabling DMA in Windows 98 or Windows 95 OSR2

Before you install the *WinDVD* software, be sure that the Direct Memory Access of your DVD-ROM drive has been enabled in Windows 98 or Windows 95 OSR2 or the video and audio playback quality might be poor.

To enable DMA for Windows 98 or Windows 95 OSR2:

1. Double-click **My Computer**.
2. Double-click **Control Panel**.
3. Double-click **System**.
4. Click the **Device Manager** tab.
5. Double-click **CDROM**.
6. Select the DVD-ROM device in the menu display.
7. Click **Properties**.
8. Click the **Settings** tab to view the DMA option in the Options window.
9. Place a check in the DMA check box to enable DMA.
10. Click **OK**.
11. Click **OK**.
12. Click **Close**.
13. Restart your computer to enable the DMA mode of your DVD-ROM drive.

Step 13. Installing the WinDVD software for Windows 98 or Windows 95 OSR2

Note: Before installing *WinDVD*, be sure to read “Changing the DVD region code” on page 1-38 to familiarize yourself with the region code concept.

To install the *WinDVD* software for Windows 98 or Windows 95 OSR2:

1. Close any programs running on the desktop.
2. Insert the *WinDVD* software CD into your DVD-ROM drive.
3. If the Installation window opens, go to step 8 below.
4. Click **Start**.
5. Select **Run**.
6. Type `x:\setup.exe` where *x* is the drive letter for your DVD-ROM drive.
7. Click **OK**.
8. Follow the on-screen instructions to complete the installation.
Note: During installation, *WinDVD* verifies that you have the most recent versions of DirectX and DirectMedia. If *WinDVD* does not find the most recent version, click **Yes** when *WinDVD* prompts you to install DirectX 6.1 or DirectMedia.
9. Restart Windows.

You have completed the installation of the *WinDVD* software for Windows 98 or Windows 95 OSR2. For information on using *WinDVD*, go to “Using the DVD software” on page 1-38.

Step 14. Software verification for Windows NT 4.0

If you are using Windows NT 4.0, refer to the documentation that comes with your computer to determine if the IDE controller on your computer supports DMA transfers.

Note: Be sure that your computer has an Intel chipset and that you are using the Service Pack 3 or the latest Service Pack for Windows NT provided by Microsoft. Refer to the documentation that comes with your computer to determine if there is an Intel chipset in your computer. For more information on installing Windows NT Service Packs, visit the Microsoft Web site at <http://microsoft.com>

If your computer IDE controller supports DMA transfers, continue with “Step 15. Installing the WinDVD software for Windows NT 4.0.”

If your computer IDE controller does not support DMA transfers, you must go to the Web site for the system board manufacturer and install the Windows NT 4.0 DMA device driver using instructions provided on the Web site.

The following is a list of manufacturer Web sites that contain Windows NT 4.0 DMA device drivers for system boards:

IBM: <http://www.ibm.com>
Intel: <http://www.intel.com>
VIA: <http://via.com.tw>
ALi: <http://ali.com.tw>

Refer to the documentation that came with your computer for information on other system board manufacturers.

Step 15. Installing the WinDVD software for Windows NT 4.0

Note: Before installing *WinDVD*, be sure to read “Changing the DVD region code” on page 1-38 to familiarize yourself with the region code concept.

To install the *WinDVD* software for Windows NT 4.0:

1. Start Windows.
2. Insert the *WinDVD* software CD into your DVD-ROM drive.
3. If the Installation window opens, go to step 4 below. If the installation window does not open, double-click **My Computer**, double-click the **CD-ROM** icon, and click the **Setup** icon.
4. Follow the on-screen instructions to complete the installation.
5. Restart Windows.
6. Use instructions given in Step 16 to enable DMA in Windows NT 4.0 or the video and audio playback might be poor.

Step 16. Enabling DMA for Windows NT 4.0

Attention: Before enabling DMA for Windows NT 4.0, be sure to read “Step 14. Software verification for Windows NT 4.0” on page 1-36 to determine if your computer can perform this upgrade procedure. If you do not perform this procedure correctly, your operating system might lock up. Therefore, be sure to build an Emergency Repair Disk before you use the following upgrade instructions. If you are not familiar with the procedure for building an Emergency Repair Disk, press F1 to obtain instructions from the Microsoft NT online help.

To enable DMA in Windows NT 4.0:

1. Log on as an Administrator.
2. Disable the CD-ROM device driver using the following instructions.
 - a. Double-click **My Computer**.
 - b. Double-click **Control Panel**.
 - c. Double-click **Devices**.
 - d. Select the **ATAPI** device.
 - e. Click **Startup**.
 - f. Click **Disabled**; then click **OK**. Disregard displayed warnings.
 - g. Select the **PIIXIDE** device.
 - h. Click **Startup**.
 - i. Click **Disabled**; then click **OK**. Disregard displayed warnings.
3. Upgrade the CD-ROM device driver using the following instructions.
 - a. Double-click **My Computer**.
 - b. Double-click **Control Panel**.
 - c. Double-click **SCSI adapters**.
 - d. Click the **Drivers** tab.
 - e. Select the **IDE CDROM** device driver; then click **Remove** and **Yes**.
 - f. Click **Add**.
 - g. Browse to the **\PIIXIDE** directory created during the installation of *WinDVD* in Step 15.
 - h. Select the **PIIXIDE** device driver and click **Open**.
 - i. Click **OK**.

The SCSI adapter will now be identified as **Intel PIIX PCI Bus Master IDE Controller**.
 - j. Click **OK**.
 - k. Select **Yes** to restart your computer.

Using the DVD software

This section describes how to use and customize the *WinDVD* software. You can find additional information on *WinDVD* in the README file on the *WinDVD* software CD.

Changing the DVD region code

Attention: Regionalization and Copy Protection (the DVD region code) uses the Content Scramble System (CSS) standard to prevent unauthorized duplication of the intellectual property rights distributed on DVDs. It was originally requested by the Motion Picture Association of America (MPAA) to address video piracy but is applicable to any content. CSS works by inhibiting the transmission of unencrypted data from the PCI bus. Playback systems must license CSS to decode the encrypted data.

The CSS specification divides the world into six unique regions. Content designated for one region cannot be read by playback systems in another region. While CSS is used to prevent digital copies of the DVD content, another technology devised by Macrovision is used to prevent analog copies of the DVD content. The Macrovision standard is a scrambling system that has been widely used by the movie industry to prevent unauthorized duplication of video content using commercial VCRs. DVD playback systems must support both CSS and Macrovision copy protection standards.

If you relocate to a different region of the world, you can use the *WinDVD* software to change the region code.

Note: You can change the DVD region code only five times. After you make five region code changes, the drive can play only MPEG-2 video titles that are associated with the fifth region code that you set.

To change the region code:

1. Turn on your computer and start your operating system.
2. Click **Start**.
3. Select **Programs**.
4. Select **Intervideo WinDVD**. (If you have created a shortcut to *WinDVD* on your desktop, you can click it instead.)
5. Click  to open the Properties window.
6. Click the **General Properties** tab.
7. Select the correct region code for your country.
8. Click **OK** so that changes take effect.

Starting the WinDVD software

When you insert a DVD into the DVD-ROM drive, the *WinDVD* software automatically detects the format of a disc and begins playing it.

To start the *WinDVD* software:

1. Turn on your computer and start your operating system.
2. Click **Start**.
3. Select **Programs**.
4. Select **Intervideo WinDVD**. (If you have created a shortcut to *WinDVD* on your desktop, you can click it instead.)
5. Make your selections from the menu within the *WinDVD* window, or click

 on the control panel.

Using the WinDVD display panel controls

This section contains information on using the controls in the *WinDVD* display panel. Refer to the following illustration for the location of the controls. For more information on the controls, press F1 to view online information.



The *WinDVD* controls are designed to look like controls on a stand-alone DVD player. Options not available on a specific DVD will be inaccessible.

Using the Start/Eject controls

This section provides information on using the *WinDVD* Start/Eject controls.



Click this button to close *WinDVD*.



Click this button to open the Playlist window so that you can select a specific order and group of files. You cannot select a file while a movie is playing. For more information on creating a playlist, go to “Creating a playlist” on page 1-44.













Click this button to open the Properties window. For more information on customizing properties in *WinDVD*, see “Customizing WinDVD properties” on page 1-44.



Click this button to eject a DVD from the DVD-ROM drive.







Using the directional controls

This section provides information on using the *WinDVD* directional controls.

-  Click this button to stop playing a DVD.
-  Click this button to start playing a DVD.
-  Click this button to pause playing a DVD.
-  Click this button to advance a single frame while the DVD is in Pause mode.
-  Click this button to replay the DVD or the current DVD chapter.
-  Click this button to go to the previous chapter.
-  Click this button to go to the next chapter.
-  Click this button to play the DVD in Fast Reverse mode.
-  Click this button to play the DVD in Fast Forward mode.
-  Click this button to restart the same chapter.

Using the sliders

This section provides information on using the *WinDVD* sliders.

-  Move this slider to view a specific time in the DVD.
-  Move this slider to make Slow Motion and Fast Forward smoother.
-  Move this slider to increase or decrease the volume.
-  Move this slider to increase or decrease the video brightness.
-  Move this Color Control Bar slider to adjust the balance of the blue and yellow colors in the video.
-  Move this Color Control Bar slider to adjust the balance of the red and green colors in the video.

Using the counter

The following illustration shows the counter from the display panel. The counter displays the chapter being played and the elapsed time since the DVD began playing.



Using the directional arrows

The following illustration shows the directional arrows on the display panel.

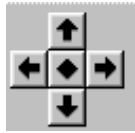

Use the buttons like a mouse button or Tab key. The arrows on the buttons represent (clockwise from the top): navigate up, navigate right, navigate down, and navigate left. You can click the center button to select or enter an option.

Using the numeric keypad

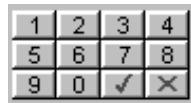

Video CDs, when played, commonly require you to select numbers. To enter a numeric value, click the corresponding key on the numeric keypad; then click the green check mark to accept that number.

Using the menu buttons

This section contains information on using the MENU, TITLE, CHAPTER, AUDIO, SUBTITLE, and ANGLE menu buttons. To enable a menu function, click the menu button. The following table shows the function of each menu button.

Menu button	Function
MENU	Displays the available menus (such as Audio Language or Subtitles) on the DVD you are playing
TITLE	Opens a submenu displaying the available titles on the DVD you are playing
CHAPTER	Displays the chapter that is being played or selects another chapter
AUDIO	Displays the audio track options on the DVD you are playing (can select another track or language if multiple audio tracks or languages are available on the disc)
SUBTITLE	Displays the subtitle menu (can select another language if multiple language subtitles are available on the DVD)
ANGLE	Selects a viewing angle if your DVD has this option

Using the right-click menu

When you are viewing a DVD movie, you can display a video pull-down menu by placing the cursor on the display window and right-clicking. To enable a DVD play function, click the desired menu selection. The following table shows the menu selections and functions.

Menu selection	Function
Play	Starts playing the current title after a pause
Stop	Stops the current playback
Pause	Pauses the current playback
Fast Forward	Plays the disc in Fast Forward mode
Fast Backward	Plays the disc in Fast Reverse mode
Previous Chapter	Jumps to the previous chapter
Next Chapter	Jumps to the next chapter
Repeat	Repeats the disc play
Mute	Mutes the sound on the disc
Eject	Ejects the disc from the drive
Menu	Displays menu selections
Title	Displays title information

Menu selection	Function
Chapter	Displays chapter selections
Subtitle	Displays subtitle selections
Audio	Displays audio track
Angle	Displays angle selections
Playlist	Displays playlist selection
Properties	Opens the Properties window
Adjustment	Opens the Audio/Video adjustment window
View	Displays tool bar, status bar, and player
About	Displays version and copyright information
Exit	Closes <i>WinDVD</i>

Using the Status Bar

When you view a DVD and select Show Status Bar from the Properties menu, *WinDVD* displays the Status Bar across the bottom of the screen, as shown in the following illustration.

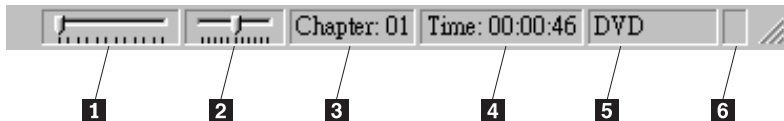

You can use the following controls in the Status Bar:

- 1 Use this slider to move to a different time in the disc.
- 2 Use this slider to make Slow Motion or Fast Forward smoother.
- 3 This displays the current chapter.
- 4 This displays the elapsed time.
- 5 This displays the disc type.
- 6 If continuous loop has been enabled, this icon displays in the far right of the status bar.

Using the adjustment and help buttons

This section provides information on using the adjustment and help buttons that display above the video screen.



Click this button to open the Audio and Video adjustment window.



Click this button to open the online help.

Creating a playlist

To create a playlist:

1. Insert a DVD into the DVD-ROM drive.
2. Click  to open the Playlist window.
3. Click **File**.
4. Select the first file to be played from the correct drive and directory. You can play .mpg, .vob, and .ac3 files.
5. Click **Add**.
6. Repeat this procedure with as many files as you want.

Remember that these files will now play in the order in which they appear. If you would like to change the order, delete and replace files.

7. Click **Save** to save your playlist for future use.
8. Click **Play** to automatically play the files in the order specified.

Loading a previously saved playlist

To load a previously saved playlist:

1. Insert a DVD into the DVD-ROM drive.
2. Click  to open the Playlist window.
3. Click **Load Playlist** to display the list of saved playlists.
4. Click **Play** to automatically play the files in the order specified.

Customizing WinDVD properties

This section contains information on customizing properties in *WinDVD*. You can customize the following properties: General, Audio, Display, and Parental Control.

General Properties

You can use the General Properties to select the drive letter for the DVD-ROM drive, to enable autostart when a disc is inserted into the DVD-ROM drive, and to hide or display the control panel.

To change features in General Properties:

1. Start *WinDVD*.
2. Click  to open the Properties window.
3. Click the **General** tab.

4. Customize the properties as desired.

Select **Default DVD Drive** to assign a drive letter for your DVD-ROM drive.

Place a check in the **Autoplay** check box if you want *WinDVD* to automatically start when you insert a DVD into the DVD-ROM drive.

Place a check in the **View Toolbar** check box to display the toolbar at the top of the video window, or remove the check from the **View Toolbar** check box to hide the toolbar.

Place a check in the **Statusbar** check box to display the status bar at the bottom of the video window, or remove the check from the **Statusbar** check box to hide the status bar.

5. Click **OK** so that the changes take effect.

Audio Properties

You can use the **Audio Properties** tab to customize audio output. To customize audio output in Audio Properties:

1. Start *WinDVD*.
2. Click  to open the Properties window.
3. Click the **Audio Properties** tab.
4. Customize the properties as desired.

Note: Your audio card might not have some audio output features. Be sure to check the documentation that comes with your audio card before you enable an audio output feature.

If you want to mix the two channels into one, place a check in the **Mono** check box

If you want to mix all audio channels on the disc down to two channels, place a check in the **Stereo** check box

If you want to receive two-channel audio output that includes Dolby Pro Logic Surround sound, place a check in the **Dolby Surround** check box

If you want to receive 3-D audio output, place a check in the **3-D Audio** check box

You might also be able to use the following audio output options:

- **4-Speaker Mode:** If your computer uses four speakers, this option is available. When you select this option, *WinDVD* automatically distributes four unique sound channels to these speakers, providing a true surround experience.

- **6-Speaker Mode:** If your computer uses six speakers, this option will be available. When you select this option, *WinDVD* automatically distributes 5.1 sound channels to these speakers.
 - **Enable S/PDIF output:** When you select this option, *WinDVD* sends the stereo output through an S/PDIF-compliant audio adapter to an external receiver.
 - **Current Audio Track:** When you select this option, *WinDVD* displays the current audio track format or audio track attributes.
5. Click **OK** so that the changes take effect.

Vocal options

You can also customize vocal options in Audio Properties if you are playing karaoke or vocal-type discs. To customize vocal output in Audio Properties:

1. Start *WinDVD*.
2. Click  to open the Properties window.
3. Click the **Audio Properties** tab.
4. Select one of the following vocal output options:
 - No vocal:** Vocals are not output to any speaker.
 - Left vocal:** Vocals are output only to left speakers.
 - Right vocal:** Vocals are output only to right speakers.
 - Both:** Vocals are output to both sides.
5. Click **OK** so that the changes take effect.

Display Properties

You can use the Display Properties tab to customize the display of the DVD output.

To customize display output in Display Properties:

1. Start *WinDVD*.
2. Click  to open the Properties window.
3. Click the **Display Properties** tab.
4. Enable one of the following quality settings:
 - Low:** Select this option to disable all features displayed in the Custom Quality settings section.
 - High:** Select this option to enable all features displayed in the Custom Quality settings section.
 - Custom:** Select this option to customize the following settings in the Custom Quality section:

- **Smooth horizontal scaling:** When you select this option, *WinDVD* displays a smoother video picture when the display window is horizontally resized on graphics adapters that do not provide for hardware scaling (enabling this feature might use extra CPU bandwidth).
- **Smooth vertical scaling:** When you select this option, *WinDVD* displays a smoother video picture when the display window is vertically resized on graphics adapters that do not provide hardware scaling (enabling this feature might use some CPU bandwidth).
- **Software Bob (de-interlacing):** When you select this option, *WinDVD* controls video “jitter” for interlaced video content (30fps), enhancing the smoothness and sharpness of the picture.

5. You can also select the following display options:

Place a check in the **Hardware Motion Compensation** check box to use the hardware motion compensation provided by your VGA card.

Place a check in the **Lock Aspect Ratio** check box to display the correct ratio when you resize the video window. The screen can then only be resized in the same dimensions as the disc format. If you do not check **Lock Aspect Ratio**, the picture might be distorted when you resize the window.

Place a check in the **Startup in full screen mode** check box to automatically open the *WinDVD* window in full-screen mode whenever you start *WinDVD*.

6. Click **OK** so that the changes take effect.

Parental Control Properties

You can use the **Parental Control** tab to set the parental controls to be sure that only age-appropriate movies and titles can be viewed. (In some cases, movies can be shown in modified form to allow different ratings for the same movie.) To set movie-rating limits in *WinDVD*:

1. Start *WinDVD*.
2. Click  to open the Properties window.
3. Click the **Parental Control** tab.
4. Select the desired age-appropriate level so that no one can view titles with movie ratings higher than the one selected. You can select one of the following levels.
 - G: Suitable for general audiences
 - PG: Parental guidance suggested
 - PG-13: Parental guidance suggested, not suitable for children under 13
 - R: Restricted
 - NC-17: Adult theme or content, not suitable for children under 17

You can change the level at any time.

5. If you have set a password, enter the password now; then click **OK**. You can change your password at any time. For information on setting and changing passwords, see “Setting and changing the parental control password” on page 1-48.
6. Click **OK** so that the changes take effect.

Setting and changing the parental control password

To set a parental control password:

1. Click **Set Password** in the Parental Control window.
2. Type your desired password in the **New Password** box.
3. Type the same password again in the **Confirm New Password** box.

Be sure to type the same password twice, or the *WinDVD* program will not accept it.

4. Click **OK** to accept the password.

To change a parental control password:

1. Type your current password in the **Old Password** box.
2. Click **Set Password** in the Parental Control window.
3. Type the new password in the **New Password** box.
4. Type the new password again in the **Confirm New Password** box.

Be sure to type the same new password twice, or the *WinDVD* program will not accept it.

5. Click **OK** to accept the new password.

Playing an interactive DVD

You do not need to perform additional procedures to play interactive DVD or MPEG-2 video-based discs. When you insert an interactive disc, *WinDVD* will play the DVD or MPEG-2 video files on the disc.

Closing WinDVD

To close *WinDVD*:

1. Stop playing any DVD in the DVD-ROM drive.
2. Click  in the *WinDVD* display panel.

Product registration

Thank you for purchasing OPTIONS by IBM . Please take a few moments to register your product and provide us with information that will help IBM to better serve you in the future. Your feedback is valuable to us in developing products and services that are important to you, as well as in developing better ways to communicate with you. Register your option on the IBM Web site at:

<http://www.ibm.com/pc/register>

IBM will send you information and updates on your registered product unless you indicate on the Web site questionnaire that you do not want to receive further information.

Product service and warranty information

For technical support, support hours, and warranty terms and conditions, see the enclosed inserts, or contact your IBM reseller or IBM marketing representative.

Part 2: Care and maintenance guide

This section includes information on taking care of your DVD-ROM drive and the CDs and DVDs you will be using with the drive.

Caring for a CD or DVD

Digital discs are high-density media that must be handled with care and kept clean to ensure that they remain readable. The following precautions will help to prolong the life of your discs.

Attention: Wiping a disc using a circular motion will damage the disc and cause data loss.

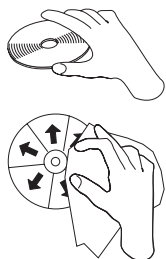

Handle the disc by the edges or the center hole. Do not touch the surface of the disc.

To remove dust or fingerprints, wipe the disc from the center to the edge with a soft, lint-free cloth.

Do not write on the surface.

Do not place the disc in direct sunlight.

Do not use commercial cleaners to clean the disc.

Do not bend the disc.

Caring for the DVD-ROM drive

To protect your DVD-ROM drive during operation, observe the following precautions.

Do not move the drive when it is in use. Doing so might cause data error or damage the drive.

Avoid exposing the drive to the following conditions.

- High humidity
- High temperature
- Excessive dust

- Mechanical vibration
- Sudden shock or dropping
- Placement on an inclined surface
- Direct sunlight
- Sudden temperature changes

Do not insert foreign objects into the drive.

Do not stack objects on the drive.

Do not remove the drive cover or attempt to service the drive.

Remove any discs from the disc drawer and make sure the drawer is closed before moving the drive unit.

Keep the original packing materials. When you need to ship the drive unit to a different location, use the original packing materials to ensure that the drive is transported safely.

Loading a disc into the DVD-ROM drive

To load a CD or DVD into a drive in a horizontal bay:

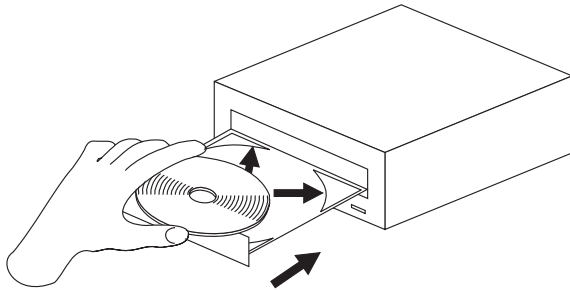

1. Press the Open/Close button on the front of the drive. The tray slides out of the drive.
2. Place the disc in the tray with the label facing up.
3. Close the tray by pressing the Open/Close button, or by gently pushing the loading tray in.

Attention: Do not use force or insert foreign objects to open the loading tray.

Securing a disc in a vertically mounted drive

If you have mounted your DVD-ROM drive in a vertical bay, you need to use the clips on the sides of the tray to secure your disc.

The DVD-ROM drive loading tray has four plastic clips that rotate over the edges of the disc and hold it in place when the drive is mounted vertically.

1. Push the Open/Close button to open the loading tray.
2. Place your disc into the loading tray.
3. Using your fingernail or something similar, gently rotate the clips toward the center of the tray until they cover the edges of the disc.
4. Close the tray by pressing the Open/Close button, or by gently pushing the loading tray in.

Manually ejecting a disc

If you press the Open/Close button and the tray does not slide out, turn off the computer and straighten a large paper clip to form a tool, as shown in the illustration. The straightened end must extend at least 45 mm (1.8 in.). Insert the extended end into the emergency eject hole on the front of the drive (see “Front view of the drive” on page 1-4). Push the paper clip until the tray opens. Gently pull out the tray until you can remove the disc.

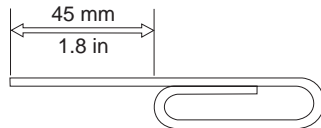

Part 3: Appendixes

This section contains information on device-driver customization, problem-solving, help and service, and product warranty and notices.

Appendix A. Customizing device-driver configuration settings

This section contains optional configuration information for the *8Xmax DVD-ROM Drive Option Diskette* device drivers for Windows 3.x, DOS, OS/2, Windows 98 and Windows 95. Use the online help during the installation and refer to the READ.ME file on the *8Xmax DVD-ROM Drive Option Diskette* for additional information.

Note: After you install the *8Xmax DVD-ROM Drive Option Diskette*, you can use a DOS session in Windows 3.x, DOS, OS/2, Windows 98, Windows 95, and Windows NT to access the drive as a data DVD-ROM drive or as a CD-ROM drive.

Requirements vary, and you might need to customize the configuration that the CDSETUP program installed on your computer. This section provides information and describes parameters that you might need to change or add for your installation.

Changing device-driver parameters for DOS and Windows

Most computers function adequately with the default settings for the IBMIDECD.SYS device driver file. However, there are some parameters that can be changed if necessary. This section explains the function of each parameter. Use a text editor to modify the appropriate line in your CONFIG.SYS file. For the IBMIDECD.SYS device driver file, the line in CONFIG.SYS is in the following format:

```
DEVICE=[drive:][path]IBMIDECD.SYS /D:device name  
      [/P:xxx,yy] [/A:n] [/U:n]  
      [/L:xx] [/T:n] [/I:n]
```

(Do not truncate the actual device driver entry. Place the complete DEVICE= statement on one line in the CONFIG.SYS file.)

The following parameter specifies the location (drive and directory) and name of the device driver file.

```
[drive:][path]IBMIDECD.SYS
```

Use the following options to configure the device driver.

D:device name

This parameter specifies the device name of the CD-ROM drive. This name must be identical to the device name specified in the MSCDEX.EXE parameters, as shown:

```
DEVICE=C:\IBMIDECD.SYS /D:IBMCD1
```

/P:xxx,yy

This parameter specifies the address and interrupt level of the port to which the IDE CD-ROM drive is connected.

The device driver automatically checks the industry standard primary IDE port (address 1F0, interrupt 14) and secondary IDE port (address 170, interrupt 15). The */P* parameter is not needed if your CD-ROM drive is connected to either of these ports. However, if your computer (or IDE adapter) uses different IDE port addresses or interrupts, you must use this option. Refer to the instructions that come with your computer or IDE adapter for more information about the configuration of your computer or adapter.

xxx is the base address of the IDE port.

1F0 for the primary IDE port (Port 1)
170 for the secondary IDE port (Port 2)

yy is the interrupt (IRQ) level.

14 for the primary IDE port (Port 1)
15 or 10 for the secondary IDE port (Port 2)

When four drives are connected, for example, the syntax in the CONFIG.SYS file would be:

```
DEVICE=C:IBMIDEC.D.SYS /D:IBMCD1 /P:1F ,14  
/P:17 ,15 /P:1E ,12 /P:16 ,1
```

(Do not truncate the actual device driver entry. Place the complete DEVICE= statement on one line in the CONFIG.SYS file.)

/A:n

This parameter specifies the audio play mode. For a stereo CD, you can type */A:0* or */A:1*. For a monaural CD (left or right channel only), type */A:1* to play the monaural audio signal from the right and left channels. The default is *n=0*.

/U:n

This parameter specifies if your computer initializes with the CD tray unlocked or locked. */U:0* initializes with the tray unlocked. */U:1* initializes with the tray locked. The default is *n=0*. You might use this parameter if you want to secure your CD in the drive.

/L:xx

This parameter specifies the message language, where *xx* designates the language.

US	English (default, does not need to be specified)
GR	German
FR	French
SP	Spanish
IT	Italian
JP	Japanese

/T:n

This parameter specifies time delays to be built into the IDE read loop. Use this parameter only in computers that do not support the IOCHRDY signal on the IDE bus, and in computers that read from the IDE port faster than the CD-ROM can provide data. This parameter is usually not required in most computers.

n is a relative timing parameter that depends on microprocessor speed. When the value of *n* increases, the drive data-transfer rate decreases. Valid values for *n* are 0 through 99. The default is *n*=0, and the /T parameter is not required.

/I:n

This parameter enables interrupt sharing. If *n*=1, interrupt sharing is enabled. If *n*=0, interrupt sharing is disabled. The default is *n*=0.

Using Microsoft CD-ROM Extensions

Microsoft CD-ROM Extensions (MSCDEX.EXE) is an executable program that works with the device driver (IBMIDECD.SYS) to enable your computer to read CDs as DOS-formatted disks. MSCDEX is designed for DOS and Windows.

The CDSETUP program automatically adds an MSCDEX statement to your AUTOEXEC.BAT file. You can modify the default MSCDEX parameters to customize your installation. This section explains the function of each parameter. Use a text editor to modify the MSCDEX statement in your AUTOEXEC.BAT file.

The following is the syntax of the MSCDEX.EXE entry in AUTOEXEC.BAT where *[drive:][path]MSCDEX.EXE* specifies the location (drive and directory) of the MSCDEX.EXE file.

```
[drive] [path]MSCDEX.EXE /D:device_name
[/M:n] [/E] [/V] [/L:drive_letter
[/K][ /S]
```

(Do not truncate the actual device-driver entry. Place the complete entry on one line in the AUTOEXEC.BAT file.)

Use the following options to configure the device driver.

/D:device name

This parameter specifies the name of the CD-ROM drive (eight characters maximum). This name must be identical to the device name specified in the device driver in the CONFIG.SYS file. For example:

```
C:\MSCDEX.EXE /D:IBMCD1
```

You might support multiple CD-ROM drives (of different types) by installing each of their device drivers (naming them different names) and placing a /D:device name statement in the MSCDEX line for each drive. For example, if you want to support an IBM IDE CD-ROM drive and an IBM SCSI CD-ROM drive, your CONFIG.SYS file would have these statements:

```
DEVICE=C:\IBMIDECD.SYS /D:IDE_CD
DEVICE=C:\IBMCDROM.SYS /D:SCSI_CD
```

and your AUTOEXEC.BAT file would include this statement:

```
C:\MSCDEX /D:IDE_CD /D:SCSI_CD
```

/M:nn

This parameter specifies the number of sector buffers for temporary storage of the most recent CD data. For example, to specify 12 sector buffers you would use:

```
C:\MSCDEX.EXE /D:IBMCD1 /M:12
```

The CDSETUP program sets this value to 10. The default value for MSCDEX with no /M parameter is 4.

You can improve CD-ROM drive performance by using larger default values. However, each buffer uses about 2 KB of memory, and too many buffer specifications might slow down your computer or interfere with other programs that have large memory-usage requirements. You might be able to specify a larger number of buffers to enhance CD-ROM drive performance without adversely affecting programs that have large memory-usage requirements by using expanded memory (see the /E option in this section) or by loading MSCDEX.EXE into high memory using instructions given in the documentation that comes with your operating system or with the memory manager.

/E

This parameter instructs the computer to use expanded memory, if available. For example:

```
C:\MSCDEX.EXE /D:IBMCD1 /E
```

Note that you must first load an expanded-memory device driver before using this option. If no expanded-memory device driver is loaded, the following error message displays:

```
Expanded Memory not present or not usable.
```

/V

This parameter instructs the computer to display a summary of RAM allocation and expanded-memory usage at startup time.

/L:drive letter

This parameter specifies the drive letter to be assigned to the first CD-ROM drive. Do not assign a letter already used by an existing drive or your computer will not be able to access the CD-ROM drive. For example, you might use:

```
C:\MSCDEX.EXE /D:IBMCD1 /L:F
```

Normally, DOS assigns the CD-ROM drive to the next available drive letter after devices such as diskette drives and hard disk drives. Therefore, use this option only if you want to assign a drive letter beyond the last letter previously allocated by DOS.

/K

This parameter instructs MSCDEX.EXE to use Kanji (Japanese) file structures, if present, rather than the default alphanumeric file structures.

/S

This parameter instructs MSCDEX.EXE to allow networked computers to share CD-ROM drives.

Conserving DOS conventional memory

If the CD-ROM drive-support software is loaded in DOS conventional memory (below 640 KB RAM), there might be insufficient memory to run some DOS applications. The CDSETUP program attempts to load the IDE CD-ROM drive device driver and MSCDEX into upper memory, when possible, to avoid this problem.

For more information on techniques to conserve conventional memory, refer to the following topics in the documentation that comes with your operating system:

DOS=UMB, DOS=HIGH,UMB (CONFIG.SYS entry)

This command enables the use of upper memory and loads DOS, MSCDEX, and the IDE CD-ROM device driver in upper memory.

HIMEM.SYS (CONFIG.SYS entry)

This is a device driver that manages extended memory (RAM memory above 1 MB). Windows automatically loads this device driver.

EMM386.EXE (CONFIG.SYS entry)

This is a device driver that allows the extended memory made available by HIMEM.SYS to be used as expanded memory. You might use the MSCDEX /E parameter with this device driver to move the cache that is allocated by MSCDEX into this memory, thus freeing some conventional memory.

MEM /C /P (use from DOS prompt)

This is a useful DOS utility that displays the current memory allocation in your computer to help you understand where device drivers and programs are located. To display the MEM parameters available, at the DOS prompt, type mem/?

Enhancing performance in DOS and Windows

The following two procedures can enhance CD-ROM drive performance.

1. Allocate more MSCDEX cache (see /M parameter for MSCDEX).
2. Allow SMARTDRV to cache CD-ROM accesses.

The CDSETUP program disables the cache CD-ROM data function. Multisession CDs are not compatible with the SMARTDRV caching method. If you do not plan to use PhotoCD or multisession CDs, you can enable caching by removing the /U parameter from the SMARTDRV line in your AUTOEXEC.BAT or CONFIG.SYS file. This might improve the performance of some CD-ROM applications. You must have SMARTDRV 5.0 or later to cache CD-ROM data.

Updating the device driver for a DOS network server

If you are using the DVD-ROM drive in a DOS Network server, you need to make the following changes:

1. Add the /S parameter to the MSCDEX line in the AUTOEXEC.BAT file.
2. Verify that the MSCDEX line is located after the line that loads the network services (NET START for IBM PC LAN program).
3. Do one of the following, depending on your operating system:

If you are using DOS 3.3, be sure that you have *PC Local Area Network (LAN) Program Corrective Service Diskette* level IP00755 or later installed.

If you are using DOS 4.0, be sure that you have *DOS Corrective Service Diskette* level UR 29015 or later installed. (The computer cannot be configured as an Extended Services Domain Controller for the IBM PC LAN Program.)

Contact your IBM reseller for more information about the *PC LAN Program Corrective Service Diskette* or the *DOS Corrective Service Diskette*.

Changing the device driver for OS/2

You might need to customize the setup that the DDINSTAL file has installed on your computer to meet your requirements. This section provides information and describes parameters that you might need to change or add for your installation.

OS/2 uses the OS2CDROM.DMD device driver

```
DEVICE=OS2CDROM.DMD [Options]
```

to control all CD-ROM devices. The following parameters are available:

/V Instructs the computer to display the installation details.

/Q Suppresses messages during initialization.

Changing the OS/2 device driver filter

OS/2 uses the device-driver filter IBMIDECD.FLT for ATAPI (IDE) CD-ROM drives.

```
BASEDEV=IBMIDECD.FLT [Options]
```

The following parameter is available:

/V Instructs the computer to display installation details.

Changing the OS/2 installable file-system driver

The file system device driver for OS/2 is CDFS.IFS. The following parameters are available:

/C:n Indicates how many 64 KB RAM segments will be used for the sector cache. The default is two 64 KB RAM segments (/C:2).

/M:n Indicates the maximum number of file sectors to be read at a time. The default is eight sectors (/M:8).

/K Uses Kanji supplementary volume descriptor.

/Q Suppresses messages during initialization.

Changing the OS/2 IDE adapter device driver

The following IDE device driver is available:

```
BASEDEV=IBM1S5 6.ADD (for ISA computers)
```

This device driver controls IDE hard disk drives and IDE CD-ROM drives. At the OS/2 command prompt, type `help IBM1S5 6` to see the optional parameters that are available for ISA computers.

Special parameters are required if your computer has an IDE controller that does not use a standard interrupt. Check the `/A` and `/IRQ` parameters in the OS/2 help utility.

If you have an IBM Micro Channel computer, an IDE device driver is available for Micro Channel architecture on the IBM Web site (<http://www.ibm.com>). At the Web site, type `IBM2IDE.ADD` in the Search box; then click **Go**.

Changing the Windows 98 and Windows 95 device drivers

Windows 98 and Windows 95 have two device-driver configuration parameters: Auto Insert Notify and DMA.

The Auto Insert Notify parameter enables the computer to start audio CD software as soon as a CD is inserted into the CD-ROM drive.

The DMA parameter improves system performance by having the system DMA controller take over the function of moving data from the CD to memory, freeing the system microprocessor to perform more important tasks. For example, activating DMA might make movies and games run more smoothly because the microprocessor will have more time to manage the video.

Changing the Auto Insert Notify and DMA parameters

To change these parameter settings from the Windows 98 or Windows 95 desktop:

1. Click **Start**.
2. Select **Settings**.
3. Click **Control Panel**.
4. Double-click **System**.
5. Select **Device Manager**.
6. Double-click **CD-ROM**.
7. Click **Properties**.
8. Select **Settings**.
9. Click **Auto Insert Notification** or **DMA**.
10. Click **OK**.

Appendix B. Problem solving

Computer problems can be caused by hardware, software, or user error. Using the information in this section, you might be able to solve problems yourself or gather helpful information you can pass on to a service technician. You might also need to refer to your computer, operating-system, or sound-adaptor publications.

Review the following list for any problem descriptions that might fit your situation.

Your computer or DVD-ROM drive does not operate correctly, or the busy indicator light does not come on.

Take the following actions.

1. Check that the disc is loaded with the label side up.
2. Check that all devices are properly connected to the computer and to the power outlet.
3. Turn off the computer, unplug the cables from the power outlets for your computer and all attached devices, and remove the computer cover.
4. Check that all power and IDE cables are securely attached. Disconnect the IDE cable and check for bent or misaligned pins. If you do not find any problems, reconnect the interface cable. Replace the computer cover, and reattach all cables and power cords. Turn on the computer, restart the operating system, and attempt to open the loading tray by pressing the **Eject/Load** button. If the tray fails to open and the busy indicator light does not display, turn off the computer and try using another 4-pin dc power cable.
5. Check that the color-coded edge on the IDE cable aligns with pin 1 on the IDE port and is closest to the power cable on the DVD-ROM drive. See “Step 5. Attaching the cables to the drive” on page 1-7.
6. Check the DVD-ROM drive and any other device on the IDE cable for the proper settings. See “Step 3. Setting the configuration jumpers” on page 1-6 for more information.
7. If the middle connector on the IDE cable is attached to the IDE port on the system board, remove the connector and reattach the cable. If there is only one device on the IDE port, attach the connector at one end of the cable to the IDE port and the connector at the other end to the device, leaving the middle connector (if there is one) open.

If there are two devices on the IDE port, attach the connector at one end of the cable to the IDE port. If there is a hard disk drive, attach it to the connector at the other end of the cable, and attach the DVD-ROM drive to the middle connector.

You cannot access the DVD-ROM drive, or the DVD-ROM (CD-ROM) icon does not display.

When the DVD-ROM drive is properly installed, a CD-ROM icon displays in the My Computer window. Double-click **My Computer**. If a CD-ROM icon is not present in the window that opens, make sure that the drive has been properly installed. Make sure that the configuration jumper is set properly. See “Step 3. Setting the configuration jumpers” on page 1-6. Restart your computer. If a drive icon is still not found, continue with the following steps.

1. Click **Start**; then select **Settings**. The Settings window will open.
2. Click **Control Panel**.
3. Click **System**.
4. Click the **Device Manager** tab.
5. Double-click **View Devices by Type**.
6. Select **Hard Disk Controllers** from the list displayed in the Device Manager window. Make sure that there are no conflicts with the controller. The device status indicates whether the controller is working properly.
7. Select **CD-ROM** from the list displayed in the Device Manager window. Verify that a CD-ROM device is present in the list and that no conflicts exist. The device status indicates whether the device is working properly.
8. Click **OK**.
9. Close all windows and restart the computer.

If the device icon is still not present, check cable connections device jumper settings, and resolve any conflicts that might exist.

The DVD-ROM drive is not recognized by the operating system, or the drive performs erratically.

Some computers have Compatible and High Performance modes for mass storage devices. Normally, the DVD-ROM drive functions better under the High Performance mode. However, if your drive is not functioning properly in that mode, you might need to use the Compatible mode.

Use the following procedure to check the configuration-setup information for your computer.

1. Access your configuration utility program.
2. Select **Devices**.
3. Scroll down to the **Mass Storage Devices** section.
4. **Mass Storage Devices** contains the entries **Primary IDE Mode** and **Secondary IDE Mode**. These entries are used to set the performance mode of each IDE port. Set the mode to **Compatible** for the port where you installed your DVD-ROM drive.

Refer to the documentation that comes with your computer for additional details on selecting IDE performance modes.

The computer does not recognize the DVD-ROM drive after the device drivers are loaded.

Check for incompatibilities among the DVD-ROM drive device driver and other device drivers or other hardware in your computer. Create a system diskette with minimum CONFIG.SYS and AUTOEXEC.BAT system files.

1. Before creating special CONFIG.SYS and AUTOEXEC.BAT files, make a backup copy of these files in a convenient directory. From a DOS prompt:

Type `copy CONFIG.SYS CONFIG.IBM` and press Enter.

Type `copy AUTOEXEC.BAT AUTOEXEC.IBM` and press Enter.

2. Insert a blank, formatted diskette into the diskette drive.
3. Copy the CONFIG.SYS and AUTOEXEC.BAT files onto the diskette.
4. Turn off the computer and ensure that the system diskette is in the diskette drive.
5. Restart the computer (the computer starts up from the system diskette).
6. Observe the startup messages and ensure that the device driver IBMIDECD.SYS loads. When MSCDEX loads, observe the drive letter that the computer assigns to the DVD-ROM drive.
7. Load a data disc into the loading tray; then wait until the Busy indicator is not lit.
8. Attempt to read the disc by typing `dir x:`, where *x* is the DVD-ROM drive assigned after the MSCDEX message.
 - If the computer is able to read the disc, a conflict probably exists among the device drivers loaded by the CONFIG.SYS or AUTOEXEC.BAT file. You need to resolve this device conflict. Refer to the documentation that comes with your computer for more information on resolving device conflicts.
 - If you are unable to access the disc, you might have a hardware problem. If you are unable to read the disc or a drive letter is not assigned by MSCDEX, go to the next step.
9. Turn off the computer, unplug the cables from the power outlets for your computer and all attached devices, and remove the computer cover.
10. Disconnect the IDE and power cable for all IDE devices except the DVD-ROM drive.
11. Configure the DVD-ROM drive as a master and connect it to the last IDE connector on the primary IDE port.
12. Reinstall the computer cover. Reconnect the keyboard; plug the power cords into electrical outlets.

13. Place the system diskette in the diskette drive and a data disc in the DVD-ROM drive.
14. Restart the computer.
15. Attempt to read the disc by typing `dir C:.` (The DVD-ROM drive is drive C because it is the only device connected to the IDE port.)
 - If the computer is able to read the disc, a conflict probably exists with one of the devices that are installed on your computer. You need to resolve this device-driver conflict. Check the configuration jumper settings for the other devices or refer to your device documentation.
 - If you are unable to access the disc, you might have a hardware problem. If the DVD-ROM drive still does not read the data disc, the DVD-ROM drive might be defective. Go to Appendix C, “Help and service information” on page 3-13.

The disc cannot be read.

Take the following actions.

1. The disc might be dirty; clean it as described in “Caring for a CD or DVD” on page 2-1.
2. The disc might be defective; try another disc.
3. The disc is not ISO-9660 or High Sierra Group (HSG) compatible. Check with your place of purchase.

There is no sound from the disc.

Take the following actions.

1. Check that you are not using a data CD or data DVD.
2. Adjust the volume control on the drive. See “Front view of the drive” on page 1-4 if headphones are connected to the front of the drive.
3. Adjust the sound-adapter volume control. See the documentation that comes with your sound adapter and audio-CD player program.
4. Turn off the computer, unplug the cables from the power outlets for your computer and all attached devices, and remove the computer cover. Ensure that the audio-signal cable connects the DVD-ROM drive with the sound adapter.

You receive a common error message.

Take the following actions for these common error messages.

– CDR-103

The disc in the DVD-ROM drive is not High Sierra or ISO 9660 format. The DVD-ROM drive does not support this format.

– **CDR-101**

The “not ready reading the drive” situation occurs if you try to access the DVD-ROM drive before the drive is ready. The Busy indicator lights when you attempt to access the drive after loading a disc into the loading tray. Wait until the Busy indicator is no longer lit before attempting to access the drive.

The connectors on the audio cables provided do not fit the connector on your audio adapter.

Some audio adapters might require a special cable. See the documentation that comes with your audio adapter.

You might have to separately purchase an audio cable for the DVD-ROM drive. If you are using an IBM computer or IBM audio adapter, refer to Appendix C, “Help and service information” on page 3-13 for assistance.

Appendix C. Help and service information

See Appendix B, “Problem solving” on page 3-8 before requesting help or service. This section contains information on how to obtain online and telephone technical support.

Online technical support

Online technical support is available during the life of your product. Online assistance can be obtained through the Personal Computing Support Web site and the IBM Automated Fax System.

<i>Online technical support</i>	
IBM Personal Computing Support Web Site	http://www.ibm.com/pc/support
IBM Automated Fax System	1-800-426-3395 1-800-465-3299 (in Canada)

During the warranty period, assistance for replacement or exchange of defective components is available. In addition, if your IBM option is installed in an IBM computer, you might be entitled to service at your location. Your technical support representative can help you determine the best alternative.

Telephone technical support

Marketing, installation, and configuration support through the HelpCenter will be withdrawn or made available for a fee, at IBM's discretion, 90 days after the option has been withdrawn from marketing. Additional support offerings, including step-by-step installation assistance, are available for a nominal fee.

To assist the technical support representative, have available as much of the following information as possible:

1. Option name
2. Option number
3. Proof of purchase
4. Computer manufacturer, model, serial number (if IBM), and manual
5. Exact wording of the error message (if any)
6. Description of the problem
7. Hardware and software configuration information for your system

If possible, be at your computer. Your technical support representative might want to walk you through the problem during the call.

For the support telephone number and support hours by country, refer to the following table or to the enclosed technical support insert. If the number is not provided, contact your IBM reseller or IBM marketing representative. Response time may vary depending on the number and nature of the calls received.

<i>Support 24 hours a day, 7 days a week</i>	
Canada	1-800-565-3344
U.S.A./Puerto Rico	1-800-772-2227

Appendix D. Product warranty and notices

Warranty Statements

The warranty statements consist of two parts: Part 1 and Part 2. Part 1 varies by country. Part 2 is the same for both statements. Be sure to read both the Part 1 that applies to your country and Part 2.

United States, Puerto Rico, and Canada (Z125-4753-05 11/97)

(Part 1 - General Terms on page 3-14)

Worldwide except Canada, Puerto Rico, Turkey, and United States (Z125-5697-01 11/97)

(Part 1 - General Terms on page 3-17)

Worldwide Country-Unique Terms

(Part 2 - Country-Unique Terms on page 3-20)

IBM Statement of Limited Warranty for United States, Puerto Rico, and Canada (Part 1 - General Terms)

This Statement of Limited Warranty includes Part 1 - General Terms and Part 2 - Country-unique Terms. The terms of Part 2 may replace or modify those of Part 1. The warranties provided by IBM in this Statement of Limited Warranty apply only to Machines you purchase for your use, and not for resale, from IBM or your reseller. The term "Machine" means an IBM machine, its features, conversions, upgrades, elements, or accessories, or any combination of them. The term "Machine" does not include any software programs, whether pre-loaded with the Machine, installed subsequently or otherwise. Unless IBM specifies otherwise, the following warranties apply only in the country where you acquire the Machine. Nothing in this Statement of Warranty affects any statutory rights of consumers that cannot be waived or limited by contract. If you have any questions, contact IBM or your reseller.

Machine - IBM 8Xmax DVD-ROM Drive

Warranty Period* - One Year

**Contact your place of purchase for warranty service information. Some IBM Machines are eligible for On-site warranty service depending on the country where service is performed.*

The IBM Warranty for Machines

3-14 IBM 8Xmax DVD-ROM Drive

IBM warrants that each Machine 1) is free from defects in materials and workmanship and 2) conforms to IBM's Official Published Specifications. The warranty period for a Machine is a specified, fixed period commencing on its Date of Installation. The date on your sales receipt is the Date of Installation, unless IBM or your reseller informs you otherwise.

During the warranty period IBM or your reseller, if approved by IBM to provide warranty service, will provide repair and exchange service for the Machine, without charge, under the type of service designated for the Machine and will manage and install engineering changes that apply to the Machine.

If a Machine does not function as warranted during the warranty period, and IBM or your reseller are unable to either 1) make it do so or 2) replace it with one that is at least functionally equivalent, you may return it to your place of purchase and your money will be refunded. The replacement may not be new, but will be in good working order.

Extent of Warranty

The warranty does not cover the repair or exchange of a Machine resulting from misuse, accident, modification, unsuitable physical or operating environment, improper maintenance by you, or failure caused by a product for which IBM is not responsible. The warranty is voided by removal or alteration of Machine or parts identification labels.

THESE WARRANTIES ARE YOUR EXCLUSIVE WARRANTIES AND REPLACE ALL OTHER WARRANTIES OR CONDITIONS, EXPRESS OR IMPLIED, INCLUDING, BUT NOT LIMITED TO, THE IMPLIED WARRANTIES OR CONDITIONS OF MERCHANTABILITY AND FITNESS FOR A PARTICULAR PURPOSE. THESE WARRANTIES GIVE YOU SPECIFIC LEGAL RIGHTS AND YOU MAY ALSO HAVE OTHER RIGHTS WHICH VARY FROM JURISDICTION TO JURISDICTION. SOME JURISDICTIONS DO NOT ALLOW THE EXCLUSION OR LIMITATION OF EXPRESS OR IMPLIED WARRANTIES, SO THE ABOVE EXCLUSION OR LIMITATION MAY NOT APPLY TO YOU. IN THAT EVENT, SUCH WARRANTIES ARE LIMITED IN DURATION TO THE WARRANTY PERIOD. NO WARRANTIES APPLY AFTER THAT PERIOD.

Items Not Covered by Warranty

IBM does not warrant uninterrupted or error-free operation of a Machine.

Unless specified otherwise, IBM provides non-IBM machines **WITHOUT WARRANTIES OF ANY KIND.**

Any technical or other support provided for a Machine under warranty, such as assistance via telephone with "how-to" questions and those regarding Machine set-up and installation, will be provided **WITHOUT WARRANTIES OF ANY KIND.**

Warranty Service

To obtain warranty service for the Machine, contact your reseller or IBM. In the United States, call IBM at 1-800-772-2227. In Canada, call IBM at 1-800-565-3344. You may be required to present proof of purchase.

IBM or your reseller provides certain types of repair and exchange service, either at your location or at a service center, to keep Machines in, or restore them to, conformance with their Specifications. IBM or your reseller will inform you of the available types of service for a Machine based on its country of installation. IBM may repair the failing Machine or exchange it at its discretion.

When warranty service involves the exchange of a Machine or part, the item IBM or your reseller replaces becomes its property and the replacement becomes yours. You represent that all removed items are genuine and unaltered. The replacement may not be new, but will be in good working order and at least functionally equivalent to the item replaced. The replacement assumes the warranty service status of the replaced item.

Any feature, conversion, or upgrade IBM or your reseller services must be installed on a Machine which is 1) for certain Machines, the designated, serial-numbered Machine and 2) at an engineering-change level compatible with the feature, conversion, or upgrade. Many features, conversions, or upgrades involve the removal of parts and their return to IBM. A part that replaces a removed part will assume the warranty service status of the removed part.

Before IBM or your reseller exchanges a Machine or part, you agree to remove all features, parts, options, alterations, and attachments not under warranty service.

You also agree to

1. ensure that the Machine is free of any legal obligations or restrictions that prevent its exchange;
2. obtain authorization from the owner to have IBM or your reseller service a Machine that you do not own; and
3. where applicable, before service is provided
 - a. follow the problem determination, problem analysis, and service request procedures that IBM or your reseller provides,
 - b. secure all programs, data, and funds contained in a Machine,
 - c. provide IBM or your reseller with sufficient, free, and safe access to your facilities to permit them to fulfill their obligations, and
 - d. inform IBM or your reseller of changes in a Machine's location.

IBM is responsible for loss of, or damage to, your Machine while it is 1) in IBM's possession or 2) in transit in those cases where IBM is responsible for the transportation charges.

Neither IBM nor your reseller is responsible for any of your confidential, proprietary or personal information contained in a Machine which you return to IBM or your reseller for any reason. You should remove all such information from the Machine prior to its return.

Production Status

Each IBM Machine is manufactured from new parts, or new and used parts. In some cases, the Machine may not be new and may have been previously installed. Regardless of the Machine's production status, IBM's appropriate warranty terms apply.

Limitation of Liability

Circumstances may arise where, because of a default on IBM's part or other liability, you are entitled to recover damages from IBM. In each such instance, regardless of the basis on which you are entitled to claim damages from IBM (including fundamental breach, negligence, misrepresentation, or other contract or tort claim), IBM is liable for no more than

1. damages for bodily injury (including death) and damage to real property and tangible personal property; and
2. the amount of any other actual direct damages, up to the greater of U.S. \$100,000 (or equivalent in local currency) or the charges (if recurring, 12 months' charges apply) for the Machine that is the subject of the claim.

This limit also applies to IBM's suppliers and your reseller. It is the maximum for which IBM, its suppliers, and your reseller are collectively responsible.

UNDER NO CIRCUMSTANCES IS IBM LIABLE FOR ANY OF THE FOLLOWING: 1) THIRD-PARTY CLAIMS AGAINST YOU FOR DAMAGES (OTHER THAN THOSE UNDER THE FIRST ITEM LISTED ABOVE); 2) LOSS OF, OR DAMAGE TO, YOUR RECORDS OR DATA; OR 3) SPECIAL, INCIDENTAL, OR INDIRECT DAMAGES OR FOR ANY ECONOMIC CONSEQUENTIAL DAMAGES (INCLUDING LOST PROFITS OR SAVINGS), EVEN IF IBM, ITS SUPPLIERS OR YOUR RESELLER IS INFORMED OF THEIR POSSIBILITY. SOME JURISDICTIONS DO NOT ALLOW THE EXCLUSION OR LIMITATION OF INCIDENTAL OR CONSEQUENTIAL DAMAGES, SO THE ABOVE LIMITATION OR EXCLUSION MAY NOT APPLY TO YOU.

IBM Statement of Warranty Worldwide except Canada, Puerto Rico, Turkey, United States (Part 1 - General Terms)

This Statement of Warranty includes Part 1 - General Terms and Part 2 - Country-unique Terms. The terms of Part 2 may replace or modify those of Part 1. The warranties provided by IBM in this Statement of Warranty apply only to Machines you purchase for your use, and not for resale, from IBM or your reseller. The term "Machine" means an IBM machine, its features, conversions, upgrades, elements, or accessories, or any combination of them. The term "Machine" does not include any software programs, whether pre-loaded with the Machine, installed subsequently or otherwise. Unless IBM specifies otherwise, the following warranties apply only in the country where you acquire the Machine. Nothing in this Statement of Warranty affects any statutory rights of consumers that cannot be waived or limited by contract. If you have any questions, contact IBM or your reseller.

Machine - IBM 8Xmax DVD-ROM Drive

Warranty Period* - One Year

**Contact your place of purchase for warranty service information. Some IBM Machines are eligible for On-site warranty service depending on the country where service is performed.*

The IBM Warranty for Machines

IBM warrants that each Machine 1) is free from defects in materials and workmanship and 2) conforms to IBM's Official Published Specifications. The warranty period for a Machine is a specified, fixed period commencing on its Date of Installation. The date on your sales receipt is the Date of Installation, unless IBM or your reseller informs you otherwise.

During the warranty period IBM or your reseller, if approved by IBM to provide warranty service, will provide repair and exchange service for the Machine, without charge, under the type of service designated for the Machine and will manage and install engineering changes that apply to the Machine.

If a Machine does not function as warranted during the warranty period, and IBM or your reseller are unable to either 1) make it do so or 2) replace it with one that is at least functionally equivalent, you may return it to your place of purchase and your money will be refunded. The replacement may not be new, but will be in good working order.

Extent of Warranty

The warranty does not cover the repair or exchange of a Machine resulting from misuse, accident, modification, unsuitable physical or operating environment, improper maintenance by you, or failure caused by a product for which IBM is not responsible. The warranty is voided by removal or alteration of Machine or parts identification labels.

THESE WARRANTIES ARE YOUR EXCLUSIVE WARRANTIES AND REPLACE ALL OTHER WARRANTIES OR CONDITIONS, EXPRESS OR IMPLIED, INCLUDING, BUT NOT LIMITED TO, THE IMPLIED WARRANTIES OR CONDITIONS OF MERCHANTABILITY AND FITNESS FOR A PARTICULAR PURPOSE. THESE WARRANTIES GIVE YOU SPECIFIC LEGAL RIGHTS AND YOU MAY ALSO HAVE OTHER RIGHTS WHICH VARY FROM JURISDICTION TO JURISDICTION. SOME JURISDICTIONS DO NOT ALLOW THE EXCLUSION OR LIMITATION OF EXPRESS OR IMPLIED WARRANTIES, SO THE ABOVE EXCLUSION OR LIMITATION MAY NOT APPLY TO YOU. IN THAT EVENT, SUCH WARRANTIES ARE LIMITED IN DURATION TO THE WARRANTY PERIOD. NO WARRANTIES APPLY AFTER THAT PERIOD.

Items Not Covered by Warranty

IBM does not warrant uninterrupted or error-free operation of a Machine.

Unless specified otherwise, IBM provides non-IBM machines **WITHOUT WARRANTIES OF ANY KIND.**

Any technical or other support provided for a Machine under warranty, such as assistance via telephone with "how-to" questions and those regarding Machine set-up and installation, will be provided **WITHOUT WARRANTIES OF ANY KIND.**

Warranty Service

To obtain warranty service for the Machine, contact your reseller or IBM. You may be required to present proof of purchase.

IBM or your reseller provides certain types of repair and exchange service, either at your location or at a service center, to keep Machines in, or restore them to, conformance with their Specifications. IBM or your reseller will inform you of the available types of service for a Machine based on its country of installation. IBM may repair the failing Machine or exchange it at its discretion.

When warranty service involves the exchange of a Machine or part, the item IBM or your reseller replaces becomes its property and the replacement becomes yours. You represent that all removed items are genuine and unaltered. The replacement may not be new, but will be in good working order and at least functionally equivalent to the item replaced. The replacement assumes the warranty service status of the replaced item.

Any feature, conversion, or upgrade IBM or your reseller services must be installed on a Machine which is 1) for certain Machines, the designated, serial-numbered Machine and 2) at an engineering-change level compatible with the feature, conversion, or upgrade. Many features, conversions, or upgrades involve the removal of parts and their return to IBM. A part that replaces a removed part will assume the warranty service status of the removed part.

Before IBM or your reseller exchanges a Machine or part, you agree to remove all features, parts, options, alterations, and attachments not under warranty service.

You also agree to

1. ensure that the Machine is free of any legal obligations or restrictions that prevent its exchange;
2. obtain authorization from the owner to have IBM or your reseller service a Machine that you do not own; and
3. where applicable, before service is provided
 - a. follow the problem determination, problem analysis, and service request procedures that IBM or your reseller provides,
 - b. secure all programs, data, and funds contained in a Machine,
 - c. provide IBM or your reseller with sufficient, free, and safe access to your facilities to permit them to fulfil their obligations, and
 - d. inform IBM or your reseller of changes in a Machine's location.

IBM is responsible for loss of, or damage to, your Machine while it is 1) in IBM's possession or 2) in transit in those cases where IBM is responsible for the transportation charges.

Neither IBM nor your reseller is responsible for any of your confidential, proprietary or personal information contained in a Machine which you return to IBM or your reseller for any reason. You should remove all such information from the Machine prior to its return.

Production Status

Each IBM Machine is manufactured from new parts, or new and used parts. In some cases, the Machine may not be new and may have been previously installed. Regardless of the Machine's production status, IBM's appropriate warranty terms apply.

Limitation of Liability

Circumstances may arise where, because of a default on IBM's part or other liability, you are entitled to recover damages from IBM. In each such instance, regardless of the basis on which you are entitled to claim damages from IBM (including fundamental breach, negligence, misrepresentation, or other contract or tort claim), IBM is liable for no more than

1. damages for bodily injury (including death) and damage to real property and tangible personal property; and
2. the amount of any other actual direct damages, up to the greater of U.S. \$100,000 (or equivalent in local currency) or the charges (if recurring, 12 months' charges apply) for the Machine that is the subject of the claim.

This limit also applies to IBM's suppliers and your reseller. It is the maximum for which IBM, its suppliers, and your reseller are collectively responsible.

UNDER NO CIRCUMSTANCES IS IBM LIABLE FOR ANY OF THE FOLLOWING: 1) THIRD-PARTY CLAIMS AGAINST YOU FOR DAMAGES (OTHER THAN THOSE UNDER THE FIRST ITEM LISTED ABOVE); 2) LOSS OF, OR DAMAGE TO, YOUR RECORDS OR DATA; OR 3) SPECIAL, INCIDENTAL, OR INDIRECT DAMAGES OR FOR ANY ECONOMIC CONSEQUENTIAL DAMAGES (INCLUDING LOST PROFITS OR SAVINGS), EVEN IF IBM, ITS SUPPLIERS OR YOUR RESELLER IS INFORMED OF THEIR POSSIBILITY. SOME JURISDICTIONS DO NOT ALLOW THE EXCLUSION OR LIMITATION OF INCIDENTAL OR CONSEQUENTIAL DAMAGES, SO THE ABOVE LIMITATION OR EXCLUSION MAY NOT APPLY TO YOU.

Part 2 - Worldwide Country-Unique Terms

ASIA PACIFIC

AUSTRALIA: The IBM Warranty for Machines: The following paragraph is added to this Section:

The warranties specified in this Section are in addition to any rights you may have under the Trade Practices Act 1974 or other legislation and are only limited to the extent permitted by the applicable legislation.

Extent of Warranty: The following replaces the first and second sentences of this Section: The warranty does not cover the repair or exchange of a Machine resulting from misuse, accident, modification, unsuitable physical or operating environment, operation in other than the Specified Operating Environment, improper maintenance by you, or failure caused by a product for which IBM is not responsible.

Limitation of Liability: The following is added to this Section: Where IBM is in breach of a condition or warranty implied by the Trade Practices Act 1974, IBM's liability is limited to the repair or replacement of the goods or the supply of equivalent goods. Where that condition or warranty relates to right to sell, quiet possession or clear title, or the goods are of a kind ordinarily acquired for personal, domestic or household use or consumption, then none of the limitations in this paragraph apply.

PEOPLE'S REPUBLIC OF CHINA: Governing Law: The following is added to this Statement:

The laws of the State of New York govern this Statement.

INDIA: Limitation of Liability: The following replaces items 1 and 2 of this Section:

1. liability for bodily injury (including death) or damage to real property and tangible personal property will be limited to that caused by IBM's negligence;
2. as to any other actual damage arising in any situation involving nonperformance by IBM pursuant to, or in any way related to the subject of this Statement of Warranty, IBM's liability will be limited to the charge paid by you for the individual Machine that is the subject of the claim.

NEW ZEALAND: The IBM Warranty for Machines: The following paragraph is added to this Section:

The warranties specified in this Section are in addition to any rights you may have under the Consumer Guarantees Act 1993 or other legislation which cannot be excluded or limited. The Consumer Guarantees Act 1993 will not apply in respect of any goods which IBM provides, if you require the goods for the purposes of a business as defined in that Act.

Limitation of Liability: The following is added to this Section: Where Machines are not acquired for the purposes of a business as defined in the Consumer Guarantees Act 1993, the limitations in this Section are subject to the limitations in that Act.

EUROPE, MIDDLE EAST, AFRICA (EMEA)

The following terms apply to all EMEA countries.

The terms of this Statement of Warranty apply to Machines purchased from an IBM reseller. If you purchased this Machine from IBM, the terms and conditions of the applicable IBM agreement prevail over this warranty statement.

Warranty Service

If you purchased an IBM Machine in Austria, Belgium, Denmark, Estonia, Finland, France, Germany, Greece, Iceland, Ireland, Italy, Latvia, Lithuania, Luxembourg, Netherlands, Norway, Portugal, Spain, Sweden, Switzerland or United Kingdom, you may obtain warranty service for that Machine in any of those countries from either (1) an IBM reseller approved to perform warranty service or (2) from IBM.

If you purchased an IBM Personal Computer Machine in Albania, Armenia, Belarus, Bosnia and Herzegovina, Bulgaria, Croatia, Czech Republic, Georgia, Hungary, Kazakhstan, Kirghizia, Federal Republic of Yugoslavia, Former Yugoslav Republic of Macedonia (FYROM), Moldova, Poland, Romania, Russia, Slovak Republic, Slovenia, or Ukraine, you may obtain warranty service for that Machine in any of those countries from either (1) an IBM reseller approved to perform warranty service or (2) from IBM.

The applicable laws, Country-unique terms and competent court for this Statement are those of the country in which the warranty service is being provided. However, the laws of Austria govern this Statement if the warranty service is provided in Albania, Armenia, Belarus, Bosnia and Herzegovina, Bulgaria, Croatia, Czech Republic, Federal Republic of Yugoslavia, Georgia, Hungary, Kazakhstan, Kirghizia, Former Yugoslav Republic of Macedonia (FYROM), Moldova, Poland, Romania, Russia, Slovak Republic, Slovenia, and Ukraine.

The following terms apply to the country specified:

EGYPT: Limitation of Liability: The following replaces item 2 in this Section:

2. as to any other actual direct damages, IBM's liability will be limited to the total amount you paid for the Machine that is the subject of the claim.

Applicability of suppliers and resellers (unchanged).

FRANCE: Limitation of Liability: The following replaces the second sentence of the first paragraph of this Section:

In such instances, regardless of the basis on which you are entitled to claim damages from IBM, IBM is liable for no more than: (items 1 and 2 unchanged).

GERMANY: The IBM Warranty for Machines: The following replaces the first sentence of the first paragraph of this Section:

The warranty for an IBM Machine covers the functionality of the Machine for its normal use and the Machine's conformity to its Specifications.

The following paragraphs are added to this Section:

The minimum warranty period for Machines is six months.

In case IBM or your reseller are unable to repair an IBM Machine, you can alternatively ask for a partial refund as far as justified by the reduced value of the unrepaired Machine or ask for a cancellation of the respective agreement for such Machine and get your money refunded.

Extent of Warranty: The second paragraph does not apply.

Warranty Service: The following is added to this Section:

During the warranty period, transportation for delivery of the failing Machine to IBM will be at IBM's expense.

Production Status: The following paragraph replaces this Section:

Each Machine is newly manufactured. It may incorporate in addition to new parts, re-used parts as well.

Limitation of Liability: The following is added to this Section:

The limitations and exclusions specified in the Statement of Warranty will not apply to damages caused by IBM with fraud or gross negligence and for express warranty.

In item 2, replace "U.S. \$100,000" with "1.000.000 DEM."

The following sentence is added to the end of the first paragraph of item 2:
IBM's liability under this item is limited to the violation of essential contractual terms in cases of ordinary negligence.

IRELAND: Extent of Warranty: The following is added to this Section:
Except as expressly provided in these terms and conditions, all statutory conditions, including all warranties implied, but without prejudice to the generality of the foregoing all warranties implied by the Sale of Goods Act 1893 or the Sale of Goods and Supply of Services Act 1980 are hereby excluded.

Limitation of Liability: The following replaces items one and two of the first paragraph of this Section:

1. death or personal injury or physical damage to your real property solely caused by IBM's negligence; and 2. the amount of any other actual direct damages, up to the greater of Irish Pounds 75,000 or 125 percent of the charges (if recurring, the 12 months' charges apply) for the Machine that is the subject of the claim or which otherwise gives rise to the claim.

Applicability of suppliers and resellers (unchanged).

The following paragraph is added at the end of this Section:
IBM's entire liability and your sole remedy, whether in contract or in tort, in respect of any default shall be limited to damages.

ITALY: Limitation of Liability: The following replaces the second sentence in the first paragraph:
In each such instance unless otherwise provided by mandatory law, IBM is liable for no more than: (item 1 unchanged) 2) as to any other actual damage arising in all situations involving non-performance by IBM pursuant to, or in any way related to the subject matter of this Statement of Warranty, IBM's liability, will be limited to the total amount you paid for the Machine that is the subject of the claim.

Applicability of suppliers and resellers (unchanged).

The following replaces the second paragraph of this Section:
Unless otherwise provided by mandatory law, IBM and your reseller are not liable for any of the following: (items 1 and 2 unchanged) 3) indirect damages, even if IBM or your reseller is informed of their possibility.

SOUTH AFRICA, NAMIBIA, BOTSWANA, LESOTHO AND SWAZILAND: Limitation of Liability: The following is added to this Section:
IBM's entire liability to you for actual damages arising in all situations involving nonperformance by IBM in respect of the subject matter of this Statement of Warranty will be limited to the charge paid by you for the individual Machine that is the subject of your claim from IBM.

TURKIYE: Production Status: The following replaces this Section:
IBM fulfils customer orders for IBM Machines as newly manufactured in accordance with IBM's production standards.

UNITED KINGDOM: Limitation of Liability: The following replaces items 1 and 2 of the first paragraph of this Section:

1. death or personal injury or physical damage to your real property solely caused by IBM's negligence;
2. the amount of any other actual direct damages or loss, up to the greater of Pounds Sterling 150,000 or 125 percent of the charges (if recurring, the 12 months' charges apply) for the Machine that is the subject of the claim or which otherwise gives rise to the claim.

The following item is added to this paragraph:

3. breach of IBM's obligations implied by Section 12 of the Sale of Goods Act 1979 or Section 2 of the Supply of Goods and Services Act 1982.

Applicability of suppliers and resellers (unchanged).

The following is added to the end of this Section:

IBM's entire liability and your sole remedy, whether in contract or in tort, in respect of any default will be limited to damages.

NORTH AMERICA

CANADA: Warranty Service: The following is added to this Section:

To obtain warranty service from IBM, call **1-800-565-3344**.

UNITED STATES OF AMERICA: Warranty Service: The following is added to this Section:

To obtain warranty service from IBM, call **1-800-772-2227**.

Notices

References in this publication to IBM products, programs, or services do not imply that IBM intends to make these available in all countries in which IBM operates. Any reference to an IBM product, program, or service is not intended to state or imply that only that IBM product, program, or service may be used. Subject to IBM's valid intellectual property or other legally protectable rights, any functionally equivalent product, program, or service may be used instead of the IBM product, program, or service. The evaluation and verification of operation in conjunction with other products, except those expressly designated by IBM, are the responsibility of the user.

IBM may have patents or pending patent applications covering subject matter in this document. The furnishing of this document does not give you any license to these patents. You can send license inquiries, in writing, to:

IBM Director of Licensing
IBM Corporation
North Castle Drive
Armonk, NY 10504-1785
U.S.A.

Any references in this publication to non-IBM Web sites are provided for convenience only and do not in any manner serve as an endorsement of those Web sites. The materials at those Web sites are not part of the materials for this IBM product and use of those Web sites is at your own risk.

Trademarks

The following terms are trademarks of the IBM Corporation in the United States or other countries or both:

Extended Services	HelpCenter	IBM
Micro Channel	OS/2	

MS-DOS, Microsoft, Windows, and Windows NT Workstation are trademarks or registered trademarks of Microsoft Corporation.

Pentium is a trademark or registered trademark of Intel Corporation.

Other company, product, and service names may be trademarks or service marks of others.

Electronic emission notices

IBM 8Xmax DVD-ROM Drive

Federal Communications Commission (FCC) Statement

Note: This equipment has been tested and found to comply with the limits for a Class B digital device, pursuant to Part 15 of the FCC Rules. These limits are designed to provide reasonable protection against harmful interference in a residential installation. This equipment generates, uses, and can radiate radio frequency energy and, if not installed and used in accordance with the instructions, may cause harmful interference to radio communications. However, there is no guarantee that interference will not occur in a particular installation. If this equipment does cause harmful interference to radio or television reception, which can be determined by turning the equipment off and on, the user is encouraged to try to correct the interference by one or more of the following measures:

- Reorient or relocate the receiving antenna.
- Increase the separation between the equipment and receiver.
- Connect the equipment into an outlet on a circuit different from that to which the receiver is connected.
- Consult an IBM authorized dealer or service representative for help.

Properly shielded and grounded cables and connectors must be used in order to meet FCC emission limits. Proper cables and connectors are available from IBM authorized dealers. IBM is not responsible for any radio or television interference caused by using other than recommended cables and connectors or by unauthorized changes or modifications to this equipment. Unauthorized changes or modifications could void the user's authority to operate the equipment.

This device complies with Part 15 of the FCC Rules. Operation is subject to the following two conditions: (1) this device may not cause harmful interference, and (2) this device must accept any interference received, including interference that may cause undesired operation.

Responsible Party:

International Business Machines Corporation
New Orchard Road
Armonk, NY 10504
Telephone: 1-919-543-2193



Tested To Comply
With FCC Standards

FOR HOME OR OFFICE USE

Industry Canada Class B emission compliance statement

This Class B digital apparatus complies with Canadian ICES-003.

Avis de conformité à la réglementation d'Industrie Canada

Cet appareil numérique de classe B est conforme à la norme NMB-003 du Canada.

Deutsche EMV-Direktive (electromagnetische Verträglichkeit)

Dieses Gerät ist berechtigt in Übereinstimmung mit dem deutschen EMVG vom 9.Nov.92 das EG-Konformitätszeichen zu führen.

Der Aussteller der Konformitätserklärung ist die IBM UK, Greenock.

Dieses Gerät erfüllt die Bedingungen der EN 55022 Klasse B.

European Union - emission directive

This product is in conformity with the protection requirements of EU Council Directive 89/366/ECC on the approximation of the laws of the Member States relating to electromagnetic compatibility.

IBM can not accept responsibility for any failure to satisfy the protection requirements resulting from a non-recommended modification of the product, including the fitting of non-IBM option cards.

This product has been tested and found to comply with the limits for Class B Information Technology Equipment according to CISPR 22 / European Standard EN 55022. The limits for Class B equipment were derived for typical residential environments to provide reasonable protection against interference with licensed communication devices.

Union Européenne - Directive Conformité électromagnétique

Ce produit est conforme aux exigences de protection de la Directive 89/336/EEC du Conseil de l'UE sur le rapprochement des lois des États membres en matière de compatibilité électromagnétique.

IBM ne peut accepter aucune responsabilité pour le manquement aux exigences de protection résultant d'une modification non recommandée du produit, y compris l'installation de cartes autres que les cartes IBM.

Ce produit a été testé et il satisfait les conditions de l'équipement informatique de Classe B en vertu de CISPR22 / Standard européen EN 55022. Les conditions pour l'équipement de Classe B ont été définies en fonction d'un contexte résidentiel ordinaire afin de fournir une protection raisonnable contre l'interférence d'appareils de communication autorisés.

Unione Europea - Directiva EMC (Conformidad electromagnética)

Este producto satisface los requisitos de protección del Consejo de la UE, Directiva 89/336/CEE en lo que a la legislatura de los Estados Miembros sobre compatibilidad electromagnética se refiere.

IBM no puede aceptar responsabilidad alguna si este producto deja de satisfacer dichos requisitos de protección como resultado de una modificación no recomendada del producto, incluyendo el ajuste de tarjetas de opción que no sean IBM.

Este producto ha sido probado y satisface los límites para Equipos Informáticos Clase B de conformidad con el Estándar CISPR22 y el Estándar Europeo EN 55022. Los límites para los equipos de Clase B se han establecido para entornos residenciales típicos a fin de proporcionar una protección razonable contra las interferencias con dispositivos de comunicación licenciados.

Union Europea - Normativa EMC

Questo prodotto è conforme alle normative di protezione ai sensi della Direttiva del Consiglio dell'Unione Europea 89/336/CEE sull'armonizzazione legislativa degli stati membri in materia di compatibilità elettromagnetica.

IBM non accetta responsabilità alcuna per la mancata conformità alle normative di protezione dovuta a modifiche non consigliate al prodotto, compresa l'installazione di schede e componenti di marca diversa da IBM.

Le prove effettuate sul presente prodotto hanno accertato che esso rientra nei limiti stabiliti per le apparecchiature di informatica Classe B ai sensi del CISPR 22 / Norma Europea EN 55022. I limiti delle apparecchiature della Classe B sono stati stabiliti al fine di fornire ragionevole protezione da interferenze mediante dispositivi di comunicazione in concessione in ambienti residenziali tipici.

Korean B급 규격 증명서

이 장치는 옥내용으로 보증되었으며 모든 환경에서 사용할 수 있습니다.

この装置は、情報処理装置等電波障害自主規制協議会（VCCI）の基準に基づくクラスB情報技術装置です。この装置は、家庭環境で使用することを目的としていますが、この装置がラジオやテレビジョン受信機に近接して使用されると、受信障害を引き起こすことがあります。
取扱説明書に従って正しい取り扱いをして下さい。

IBM

Part Number: P00N7848

Printed in U.S.A.

P N7848

