

**GMB-486APS  
486 PCI Green  
Mainboard  
User's Guide**

Version 1.00



---

## TRADEMARKS

Windows, MS-DOS, and MS Word are trademarks of Microsoft Corporation.

Novell, Netware are trademarks of Novell, Inc.

Lotus, 1-2-3, and Symphony are trademarks of Lotus Development Corporation.

PC, AT, PC-DOS, OS/2 and Presentation Manager are trademarks of IBM Corporation.

WordPerfect is a trademark of WordPerfect Corporation. WordStar is a trademark of WordStar Corporation.

UNIX is the trademark of AT&T.

All other brand and product names are trademarks or registered trademarks of their respective companies.

The information presented in this publication has been carefully checked for reliability; however, no responsibility is assumed for inaccuracies, whereas, specification is subjected to change without notice.

## WARNING

For the system to operate normally, please make sure J1 of the mainboard is set as below. Refer to Fig 2 in this manual for the location J1.

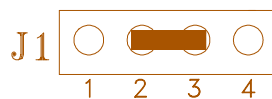

If J1 is open, no CMOS data can be retained.

---

# CONTENTS

<b>CHAPTER 1</b>	<b>INTRODUCTION</b>	<b>1</b>
1.1	GENERAL SPECIFICATION	1
1.2	MAINBOARD COMPONENTS	4
<b>CHAPTER 2</b>	<b>MEMORY CONFIGURATION</b>	<b>5</b>
2.1	SYSTEM MEMORY	5
2.2	CACHE MEMORY CONFIGURATION	10
<b>CHAPTER 3</b>	<b>JUMPER SETTINGS AND CONNECTORS</b>	<b>11</b>
3.1	CPU TYPE	11
3.2	SETTING THE JUMPERS	15
3.3	CONNECTION THE MOTHERBOARD	20
	3.3.1 JUMPER PRESENTATION	20
	3.3.2 CONNECTOR LOCATIONS	21
3.4	CONNECTORS	22
	3.4.1 J2 - RESET SWITCH CONNECTOR	22
	3.4.2 J3 TURBO SWITCH CONNECTOR	22
	3.4.3 J4 - TURBO LED CONNECTOR	23
	3.4.4 J7 - HARD DISK LED CONNECTOR	23
	3.4.5 J6 SPEAKER CONNECTOR	23
	3.4.6 J5 - KEYLOCK CONNECTOR	24
	3.4.7 IDE1 PRIMARY IDE CONNECTOR	24
	3.4.8 IDE2 SECONDARY IDE CONNECTOR	24
	3.4.9 COM1 SERIAL PORT 1 CONNECTOR	24
	3.4.10 COM2 SERIAL PORT 2 CONNECTOR	24
	3.4.11 PRN1 PARALLEL PORT CONNECTOR	24
	3.4.12 FDC1 FLOPPY DRIVE CONTROLLER	25
	3.4.13 KB2 - KEYBOARD CONNECTOR	25
	3.4.14 IR1 - OPTIONAL SERIAL INFRA RED CONNECTOR	25
	3.4.15 P1 + P2 - POWER SUPPLY CONNECTOR	26
	3.4.16 JP21 - GREEN PC BREAK SWITCH	27
	3.4.17 J1 - EXTERNAL BATTERY CONNECTOR	27

---

		iii
3.5	JUMPERS	28
3.6	GRAPHICAL DESCRIPTION OF THE JUMPER SETTINGS	29
3.6.1	CPU TYPE	29
3.6.2	CPU CLOCK SELECTION	34
3.6.3	JP3 - CPU VOLTAGE SELECTION	36
3.6.4	CACHE SIZE SETTING	39
3.6.5	J1 - DISCHARGE CMOS RAM	40
3.6.6	JP9 - FLASH BIOS VOLTAGE SELECTION	41
<b>CHAPTER 4</b>	<b>HARDDISK INSTALLATION</b>	<b>43</b>
4.1	CONNECTING THE IDE DEVICES TO THE MAINBOARD	43
4.2	HARDWARE/SOFTWARE PCI IDE DRIVER INSTALLATION	44
<b>CHAPTER 5</b>	<b>AWARD BIOS SETUP GUIDE</b>	<b>45</b>
5.1	AWARD BIOS SETUP	45
5.2	STANDARD CMOS SETUP	47
5.3	BIOS FEATURES SETUP	49
5.4	CHIPSET FEATURES SETUP	53
5.5	POWER MANAGEMENT SETUP MENU	57
5.6	PCI CONFIGURATION SETUP	59
5.7	LOAD SETUP DEFAULTS MENU	61
5.8	SUPERVISOR PASSWORD	61
5.9	USER PASSWORD	62
5.10	IDE HDD AUTO DETECTION	62
5.11	HDD LOW LEVEL FORMAT MENU	63
5.12	SCSI HARD DISK INSTALLATION	66
5.13	SAVE & EXIT SETUP MENU	66
5.14	EXIT WITHOUT SAVING MENU	66

---

# CHAPTER 1 INTRODUCTION

The mainboard is designed based on the latest PCI (Peripheral Component Interconnect) local bus standard that provides the highest performance with the basic elements to build an advanced computer. The mainboard running from 25MHz to 133MHz supports different 486 CPUs.

## 1.1 GENERAL SPECIFICATION

### Processor

- Intel SL Enhanced 80486SX/DX/DX2, P24D/P24T/P24C (DX4)
- AMD's Am486DX2/DX4, Enhanced Am486DX2/DX4, AMD-5x86
- Cyrix's Cx486DX/DX2/DX2-V66/V80/DX4-GP/DX4-GP4, Cx5X86-100
- IBM 486-4V3100GC/GIC
- SGS Thomson ST486DX/DX2/DX4V
- TI 486DX2/DX4
- UMC U5S-Super
- The mainboard can run from 25MHz to 133MHz

### Chipset

- ALI M1487 ISA Bus Controller
- ALI M1489 Cache Memory and PCI Controller
- ALI M5113 Advanced Super I/O Controller

### Cache Size

- Write Back Cache with standard SRAM
- Cache size option is 128KB/256KB/512KB

**Main Memory**

- Mainboard can decode the DRAM space up to 128MB, from combination of 256K\*36 to 8M\*36 double side SIMM module (32-bit non-parity 72-pin SIMM module also available).
- Support both Fast Page Mode and Extended Data Output (EDO) Mode DRAM Modules.
- Hidden DRAM Refresh for higher system performance.

**Multi I/O**

- On board Multi-I/O supports two serial, one parallel ports and floppy drive controller.
- Serial ports are 16550 Fast UART compatible.
- Parallel port has EPP and ECP capabilities.
- Optional Infra Red Connector for wireless communication is provided.

**PCI IDE**

- On board provides 2 enhanced PCI IDE channels, two connectors support up to four IDE devices such as HDD, CD ROM drive and Tape Back-up drives, etc.
- PCI IDE controller supports PIO Mode 3 and 4 Harddisk.

**System BIOS**

- Award Plug and Play BIOS (128KB EPROM or Flash EPROM).

**Slots**

- Four PCI slots with 3 PCI Masters
- Four ISA slots

Introduction

3

**Board**

- 4 Layer

**Form Factor**

- 220mm (W) x 220mm (L)

## 1.2 MAINBOARD COMPONENTS

This section gives a brief description of key components on the mainboard. Please refer to Fig 1 for component locations.

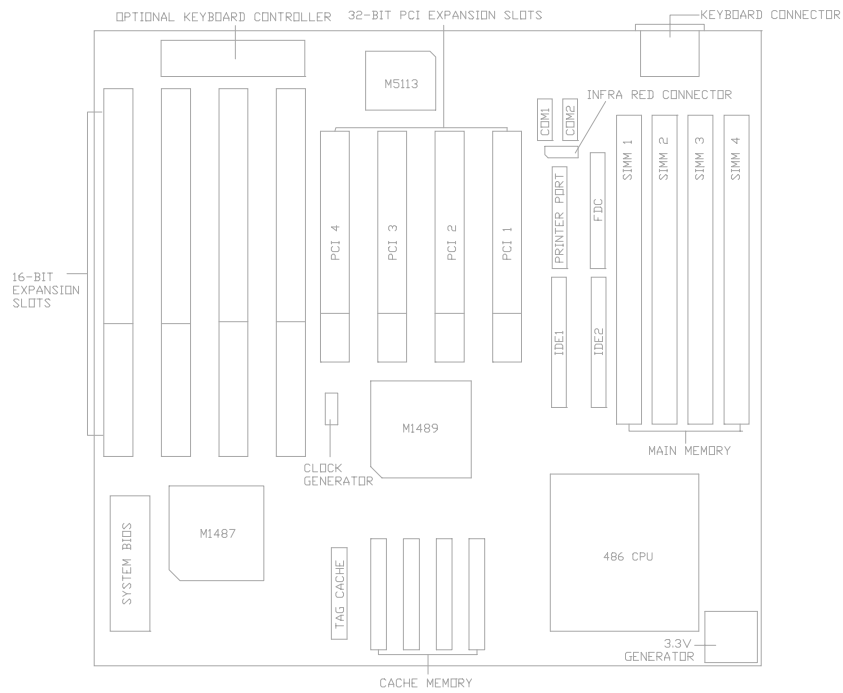

**Fig. 1 Key Components of the Mainboard**



---

## CHAPTER 2

## MEMORY CONFIGURATION

### 2.1 SYSTEM MEMORY

Both single sided and double sided DRAM modules are supported. The mainboard can decode the DRAM space up to 128MB.

Both 36 bits and 32 bits (non-parity) SIMM are supported, and user can install either 1/2/4/8/16/32MB SIMM (72-pin) in each SIMM socket. SIMM speed required for best performance depends on the CPU speed, which requires 70ns SIMM.

*Note: This mainboard supports 4 Row of DRAMs each 32 bits or 36 bits wide. The 4 Rows of DRAMs may be implemented in 4 banks of single-sided SIMMs, 2 banks of double-sided SIMMs or any other combinations as required.*

The following tables list all the possible DRAM of SM1/SM3 and SM2/SM4 module combinations.

*Note: Total Memory Size = Group 1 Size + Group 2 Size Depending on the total memory size, you can make any combination between group1 and group2*

<b>SM1</b>	<b>SM3</b>	<b>Group1 Size</b>
None	None	0MB
256Kx36 single	None	1MB
256Kx36 single	256Kx36 single	2MB
256Kx36 double	None	2MB
1Mx36 single	None	4MB
1Mx36 single	256Kx36 single	5MB
1Mx36 single	1Mx36 single	8MB
1Mx36 double	None	8MB
2Mx36 single	None	8MB
2Mx36 single	256Kx36 single	9MB
2Mx36 single	1Mx36 single	12MB
2Mx36 single	2Mx36 single	16MB
2Mx36 double	None	16MB
4Mx36 single	None	16MB
4Mx36 single	256Kx36 single	17MB
To be continue...		

Memory Configuration

<b>SM1</b>	<b>SM3</b>	<b>Group1 Size</b>
4Mx36 single	1Mx36 single	20MB
4Mx36 single	2Mx36 single	24MB
4Mx36 single	4Mx36 single	32MB
4Mx36 double	None	32MB
8Mx36 single	None	32MB
8Mx36 single	256Kx36 single	33MB
8Mx36 single	1Mx36 single	36MB
8Mx36 single	2Mx36 single	40MB
8Mx36 single	4Mx36 single	48MB
8Mx36 single	8Mx36 single	64MB
8Mx36 double	None	64MB

<b>SM2</b>	<b>SM4</b>	<b>Group2 Size</b>
None	None	0MB
256Kx36 single	None	1MB
256Kx36 single	256Kx36 single	2MB
256Kx36 double	None	2MB
1Mx36 single	None	4MB
1Mx36 single	256Kx36 single	5MB
1Mx36 single	1Mx36 single	8MB
1Mx36 double	None	8MB
2Mx36 single	None	8MB
2Mx36 single	256Kx36 single	9MB
2Mx36 single	1Mx36 single	12MB
2Mx36 single	2Mx36 single	16MB
2Mx36 double	None	16MB
4Mx36 single	None	16MB
4Mx36 single	256Kx36 single	17MB
4Mx36 single	1Mx36 single	20MB
4Mx36 single	2Mx36 single	24MB
4Mx36 single	4Mx36 single	32MB
4Mx36 double	None	32MB
To be continue...		

Memory Configuration

<b>SM2</b>	<b>SM4</b>	<b>Group2 Size</b>
8Mx36 single	None	32MB
8Mx36 single	256Kx36 single	33MB
8Mx36 single	1Mx36 single	36MB
8Mx36 single	2Mx36 single	40MB
8Mx36 single	4Mx36 single	48MB
8Mx36 single	8Mx36 single	64MB
8Mx36 double	None	64MB

The following tables list the illegal sample of SM1/SM3 and SM2/SM4 module combinations.

<b>SM1</b>	<b>SM3</b>	<b>Group1 Size</b>
1Mx36 single	1Mx36 double	(single/double)
1Mx36 double	1Mx36 single	(double/single)
1Mx36 double	1Mx36 double	(double/double)

<b>SM2</b>	<b>SM4</b>	<b>Group2 Size</b>
1Mx36 single	1Mx36 double	(single/double)
1Mx36 double	1Mx36 single	(double/single)
1Mx36 double	1Mx36 double	(double/double)

**Note: the minimum memory size for starting up the system is 2MB.**

## 2.2 CACHE MEMORY CONFIGURATION

If external standard SRAM is installed on U18-U21 for the cache system. Sizing of 128KB, 256KB and 512KB may be configured. The cache controller is direct mapping with write-back operation.

The following table describes the chip capacity and socket location required for each cache size configuration. User can use 32Kx8-bit, 64Kx8-bit, or 128Kx8-bit SRAM chips in the Data RAM sockets, and 8Kx8-bit, 16Kx8-bit or 32Kx8-bit SRAM chips in the Tag RAM socket. 15ns (tag and data) SRAM is recommended.

Cache Type	Cache Size	Tag RAM (U17)	Data RAM Group 1 U18-U21
Asyn.	256KB	16Kx8	64Kx8
Asyn.	512KB	32Kx8	128Kx8
Asyn.	128KB	8Kx8	32Kx8

Secondary Cache Configuration Table

---

**CHAPTER 3**
**JUMPER  
SETTINGS AND  
CONNECTORS**
**3.1 CPU TYPE**

The following table lists the detail descriptions of different CPU processors.

<b>Intel CPU</b>	
<b>SL Enhanced Intel 486 SX processor (PGA)</b>	
A80486SX-xx	Product name: frequency-xxMHz
xxxxxxx:	FPO number
&E5V1X SX###:	&E=SL Enhanced; 5 volt; 1X clock; spec #
INTEL [M][C]'89'92	
<b>SL Enhanced Intel 486SX2 processor</b>	
A80486SX2-50	Product name: frequency
xxxxxxx:	FPO number
&E5V1X SX###:	&E=SL Enhanced; 5 volt; spec #
INTEL [M][C]'89'92	
To be continue...	

<b>Intel CPU</b>	
<b>SL Enhanced Intel 486 DX processor</b>	
A80486DX-33	Product name: frequency
xxxxxxx:	FPO number
&E5V1X SX###:	&E=SL Enhanced; 5 volt; 1X clock; spec #
INTEL [M][C]'89'92	
<b>SL Enhanced Intel 486DX2 processor</b>	
A80486DX2-xx	Product name: frequency-xx MHz
xxxxxxx:	FPO number
&E5V1X SX###:	&E=SL Enhanced; 5 volt; spec #
INTEL [M][C]'89'92	
<b>SL Enhanced Intel 486DX2 L1-WB processor -- (P24D)</b>	
A80486DX2-xx	Product name: frequency-xx MHz
xxxxxxx:	FPO number
&E5V1X SX###:	&E=SL Enhanced; 5 volt; spec #
INTEL [M][C]'89'92	
<b>SL Enhanced Intel 486DX4 L1-WB processor (P24D)</b>	
A80486DX4-xx	Product name: frequency-xxMHz
xxxxxxx:	FPO number
&E 3VOLT Q0###:	&E=SL Enhanced; L1 Cache Write Back; 3.3 volt
INTEL [M][C]'89'92	
To be continue...	



Intel CPU	
<b>SL Enhanced Intel 486DX4 processor (P24C)</b>	
A80486DX4-xx	Product name: frequency-either 75MHz/100MHz
xxxxxxx:	FPO number
&E 3VOLT SX###:	&E=SL Enhanced; 3.3 volt
INTEL [M][C]'89'92	
<b>Non-SL Enhanced Intel 486SX/DX/SX2/DX2 CPU processors</b>	
A80486XX-xx	Product name: frequency-xx MHz
xxxxxxx:	FPO number
SX###:	5 volt
INTEL [M][C]'89'92	

AMD CPU

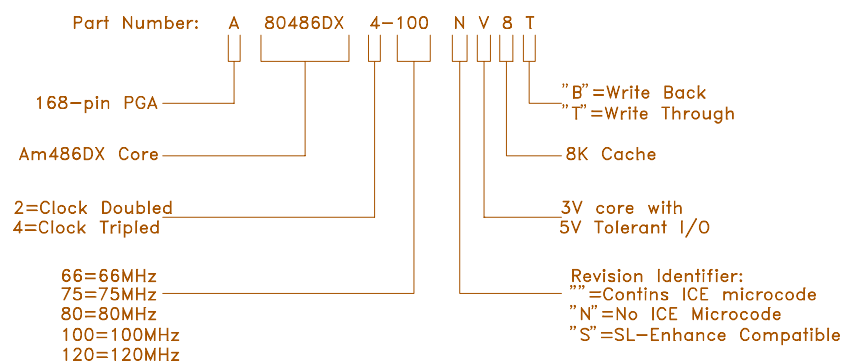

<b>AMD-5x86 CPU</b>			
Part Number	CPU Frequency	Nominal Voltage	Voltage Range
AMD 5x86-P75 (AMD-X5-133)	133MHz	3.45V	3.00 - 3.60 Volts

<b>Cyrix, SGS Thomson, IBM and TI CPU</b>			
Part Number	CPU Frequency	Nominal Voltage	Voltage Range
Cx486S2	40/50MHz	5 Volts	4.75 - 5.25 Volts
Cx486DX	40/50MHz	5 Volts	4.75 - 5.25 Volts
Cx486DX2	80MHz	5 Volts	4.75 - 5.25 Volts
Cx486DX2-V66	66MHz	3.6 Volts	3.45 - 3.75 Volts
Cx486DX2-V80	80MHz	4.0 Volts	3.80 - 4.20 Volts
Cx486DX4-100GP TI486DX2-80 IBM486-4V3100GC	100MHz	3.45 Volts	3.15 - 3.45 Volts
Cx486DX4-100GP4 ST486DX4V10HS	100MHz	3.45 Volts	3.15 - 3.45 Volts
Cx5X86-100GP IBM486-4V3100GIC	100MHz	3.3 Volts	3.15 - 3.45 Volts

### 3.2 SETTING THE JUMPERS

The table summaries the functions and settings of each jumper of the mainboard.

Function	Selection	Jumper Setting
CPU Type	Intel 80486DX2/DX4(P24C)(SL-Enhanced) AMD Am486DX2/DX4(NV8T) Cyrix 486DX4-GP4 SGS Thomson ST486DX4V10HS	JP19 2-3 close JP20 open JP22 open JP23 1-2 close JP24 1-2 close JP25 close JP26 3-4 close JP27 1-2 close JP28 2-3 close JP29 open
	Intel 80486DX2(P24D)(SL-Enhanced L1WB) Enhanced AMD Am486DX2/DX4(SV8B) AMD-5x86 (AMD-X5)	JP19 2-3 close JP20 open JP22 5-6 close JP23 2-3 close JP24 1-2 close JP25 close JP26 3-4 close JP27 1-2 close JP28 2-3 close JP29 3-4 close
	Intel 80486DX/DX2 AMD Am486DX/DX2	JP19 2-3 close JP20 open JP22 open JP23 1-2 close JP24 open JP25 open JP26 1-2 close JP27 open JP28 2-3 close JP29 open
To be continue...		

Function	Selection	Jumper Setting
CPU Type	Intel 80487SX	JP19 1-2 close JP20 open JP22 open JP23 1-2 close JP24 open JP25 open JP26 1-2 close JP27 open JP28 2-3 close JP29 open
	Intel 80486SX/SX2(SL-Enhanced)	JP19 open JP20 open JP22 open JP23 1-2 close JP24 1-2 close JP25 close JP26 3-4 close JP27 1-2 close JP28 1-2 close JP29 open
	Intel 80486SX	JP19 open JP20 open JP22 open JP23 1-2 close JP24 open JP25 open JP26 1-2 close JP27 open JP28 1-2 close JP29 open
To be continue...		

Function	Selection	Jumper Setting
CPU Type	Intel P24T	JP19 1-2 close JP20 open JP22 open JP23 2-3 close JP24 1-2 close JP25 close JP26 3-4 close JP27 1-2 close JP28 2-3 close JP29 open
	Cyrix DX/DX2/DX2-V/DX4-GP TI 486DX2 IBM 486-4V3100GC	JP19 2-3 close JP20 open JP22 1-2 close JP23 1-2 close JP24 3-4 close JP25 close JP26 5-6 close JP27 3-4 close JP28 2-3 close JP29 1-2 close
	Cyrix Cx5X86 IBM 486-4V3100GIC	JP19 2-3 close JP20 open JP22 5-6 close JP23 1-2 close JP24 1-2 close JP25 close JP26 3-4 close JP27 1-2 close JP28 2-3 close JP29 3-4 close
	UMC U5S-SUPER	JP19 2-3 close JP20 open JP22 open JP23 1-2 close JP24 open JP25 open JP26 1-2 close JP27 open JP28 2-3 close JP29 open

Function	Selection	Jumper Setting
AMD 486DX2/DX4(NV8T)	3X CPU Clock	JP20 open
	2X CPU Clock	JP20 close
Intel 486DX4(P24C) Cyrix 486DX4-GP4 ST486DX4V10HS	3X CPU Clock	JP22 open
	2X CPU Clock	JP22 3-4 close
Intel 80486DX2(P24D) Enhanced AMD Am486DX2/DX4 (SV8B)	3X CPU Clock	JP22 3-4 close 5-6 close
	2X CPU Clock	JP22 5-6 close
AMD-5x86 (AMD-X5)	4X CPU Clock	JP22 3-4 close 5-6 close
	3X CPU Clock	JP22 5-6 close
CPU Clock Select	25MHz	JP2 1-2 close JP5 open JP6 open JP7 1-2 close JP8 open
	33MHz	JP2 1-2 close JP5 close JP6 close JP7 1-2 close JP8 open
	40MHz	JP2 2-3 close JP5 close JP6 open JP7 2-3 close JP8 close
To be continue...		

<b>Function</b>	<b>Selection</b>	<b>Jumper Setting</b>
CPU Voltage	5V	JP13 1-2 close
	3.3V	JP13 3-4 close
	3.45V	JP13 5-6 close
	3.6V	JP13 7-8 close
	4.0V	JP13 open
Cache Size	128KB	JP15 open JP30 2-3 close
	256KB	JP15 2-3 close JP30 1-2 close
	512KB	JP15 1-2, 3-4 close JP30 1-2 close
Clear RTC CMOS Data	Normal	J1 2-3 close
	Clear	J1 1-2 close
	External Battery	J1 1-4 close
System ROM Selection	5V Flash ROM/Standard EPROM	JP9 1-2 close
	12V Flash ROM	JP9 2-3 close
Turbo SW	Turbo	J3 close
	De-Turbo	J3 open

### 3.3 CONNECTION THE MOTHERBOARD

Once the mainboard have been fastened into the system case, the next step is to connect the internal cables. The internal cables are wire leads with plastic female connectors that attach to the connectors. Make sure the cables and the connectors are all aligned with Pin 1 position. The mainboard connectors have varying numbers of pins and are the points of contact between the mainboard and other parts of the computer.

A description of each connector and its connector pins follows. See following Fig. 3 for the location of the connectors on the mainboard.

*Note: Before making connectors on the board, make sure that power to the system is turned off.*

#### 3.3.1 JUMPER PRESENTATION

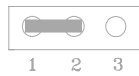

Pins 1 and 2 are shorted with a jumper cap.

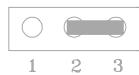

Pins 2 and 3 are shorted with a jumper cap.



The jumper is shorted when the jumper cap is placed over the two pins of the jumper.



The jumper is open when the jumper cap is removed from jumper.



### 3.3.2 CONNECTOR LOCATIONS

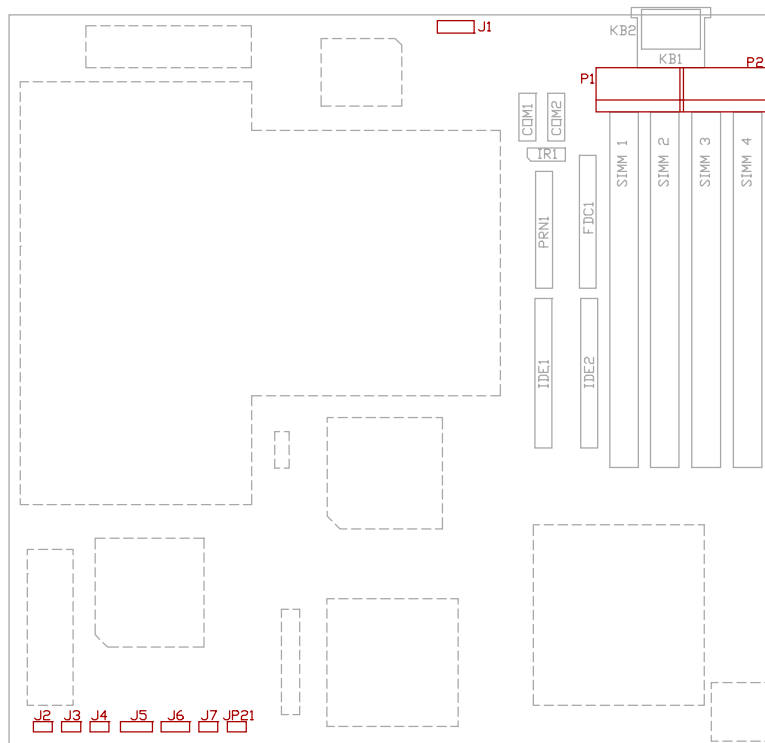



**Fig. 3 Connector Locations**

## 3.4 CONNECTORS



### 3.4.1 J2 - RESET SWITCH CONNECTOR

Attach the Reset switch cable to this connector. The Reset switch restarts the system. Refer to Fig. 3 for its location.

J2	Description
	Reset
	Normal (default)

### 3.4.2 J3 TURBO SWITCH CONNECTOR

J3 connects to the Turbo Switch, which is used to select the mainboard clock speed.

J3	Description
	Turbo Mode
	De-Turbo Mode

### 3.4.3 J4 - TURBO LED CONNECTOR

J4 is usually connected to a Turbo LED on front of the system case. If the system board select is in Turbo mode, the indicator lights during high-speed operation.



### 3.4.4 J7 - HARD DISK LED CONNECTOR

J7 connects to the HDD LED on the front panel of the system case.



### 3.4.5 J6 SPEAKER CONNECTOR

Attached the system speaker to connector J6. Refer to Fig. 3 for its location.

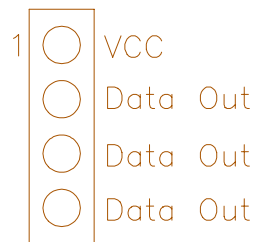

### 3.4.6 J5 - KEYLOCK CONNECTOR

J5 is a keylock connector that enables and disables the keyboard.

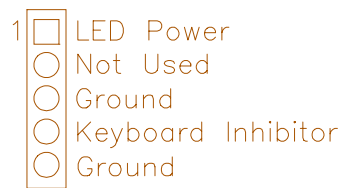

### 3.4.7 IDE1 PRIMARY IDE CONNECTOR

The bootable Hard Disk must connect to this Primary IDE Connector.

### 3.4.8 IDE2 SECONDARY IDE CONNECTOR

IDE2 locates right to IDE1, the primary IDE connector

### 3.4.9 COM1 SERIAL PORT 1 CONNECTOR

Both COM 1 and 2 are 16550 fast UART compatible. COM1 is located left beside P1 Power Connector. Pin 1 is on the up left hand side.

### 3.4.10 COM2 SERIAL PORT 2 CONNECTOR

COM2 is on the right of COM1. Pin 1 is on the up left hand side.

### 3.4.11 PRN1 PARALLEL PORT CONNECTOR

PRN1 is a 26 pin connector. Pin 1 is on the up left hand side.

### 3.4.12 FDC1 FLOPPY DRIVE CONTROLLER

FDC1 locates between DRAM SIMM socket and PRN1 Parallel Port Connector. This Floppy drive controller also supports 2.88M FDD format.

### 3.4.13 KB2 - KEYBOARD CONNECTOR

A standard five-pin female DIM keyboard connector is located at the rear of the keyboard. Plug the jack on the keyboard cable into this connector.

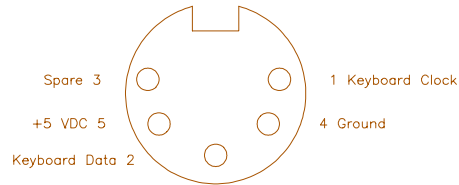

### 3.4.14 IR1 - OPTIONAL SERIAL INFRA RED CONNECTOR

IR1 is a 4 pin connector. It supports Serial Infra Red (SIR) and Amplitude Shift Keyed IR (ASKIR) for wireless communications.





### 3.4.15 P1 + P2 - POWER SUPPLY CONNECTOR

The power supply connector has two six-pin male header connectors. Plug the dual connectors from the power directly onto the board connector.

Pin	Description
1	Power Good (Orange)
2	+5 VDC (Red)
3	+12 VDC (Yellow)
4	-12 VDC (Blue)
5	Ground (Black)
6	Ground (Black)
7	Ground (Black)
8	Ground (Black)
9	-5 VDC (White)
10	+5 VDC (Red)
11	+5 VDC (Red)
12	+5 VDC (Red)

### 3.4.16 JP21 - GREEN PC BREAK SWITCH

JP21 is for Green PC Break Switch setting. When the break switch is pressed, it caused an suspend immediately or leave power saving state. Refer to Fig. 3 for its location.

JP21	Description
	Normal
	Power Down

### 3.4.17 J1 - EXTERNAL BATTERY CONNECTOR

The mainboard has a battery on-board; however, user can also attach an external battery on connector J1. Using an external battery helps to conserve the on-board battery.

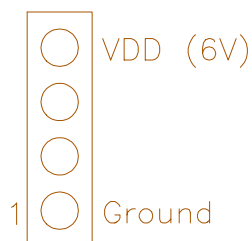

### 3.5 JUMPERS

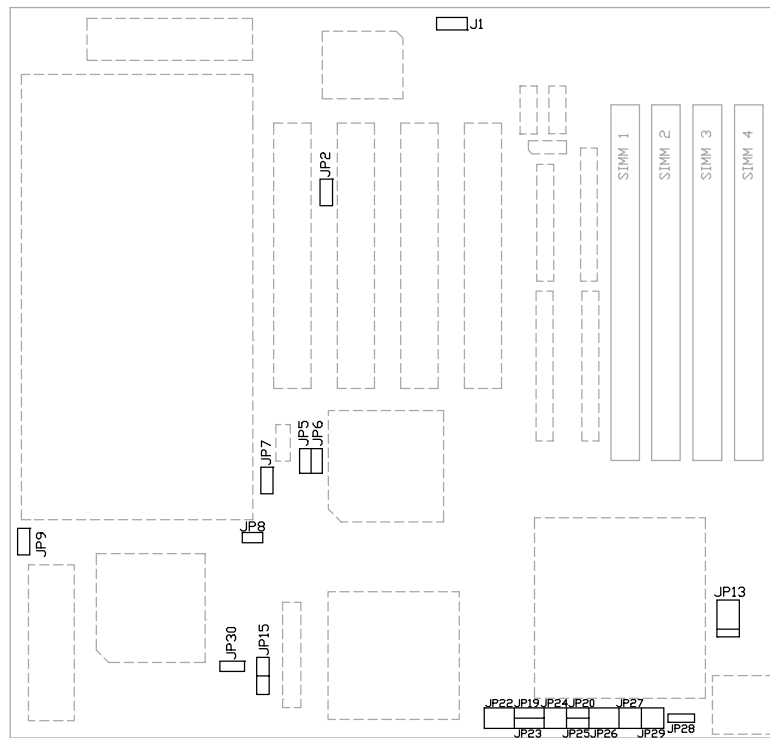

Fig. 4 Jumper and Memory Bank Locations



### 3.6 GRAPHICAL DESCRIPTION OF THE JUMPER SETTINGS

#### 3.6.1 CPU TYPE

1. Intel 80486DX2/DX4(P24C)(SL-Enhanced)  
 AMD Am486DX2/DX4(NV8T)  
 Cyrix 486DX4-GP4  
 SGS Thomson 486DX4V

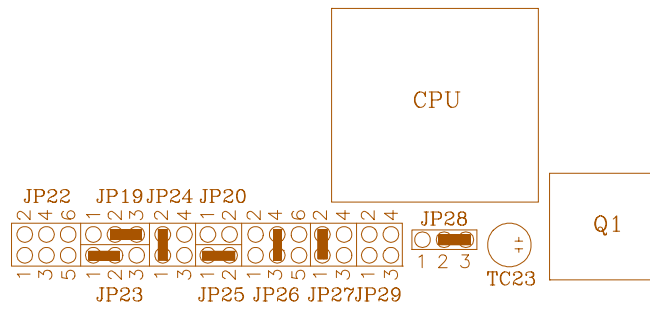

Note: JP20 close: Am486DX2/DX4 (NV8T) 2X CPU Clock  
 JP20 open : Am486DX4 (NV8T) 3X CPU Clock  
 JP22 short 3-4: Intel 486DX4 (P24C) 2X CPU Clock  
 JP22 open : Intel 486DX4 (P24C), Cyrix 486DX4-GP4,  
 SGS Thomson 486DX4V 3X CPU Clock

2. Intel 80486DX2 (P24D)(SL-Enhanced L1WB)  
Enhanced AMD Am486DX2/DX4 (SV8B)  
AMD-5x86 (AMD-X5)

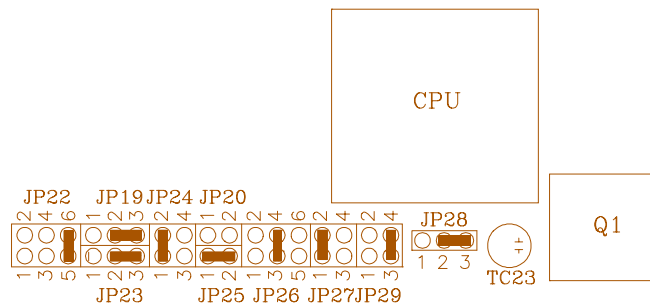

Note: JP22 short 3-4, 5-6: Am486DX2/DX4 (SV8B) 2X Clock,  
AMD-5x86 4X Clock  
JP22 short 5-6: Am486DX4 (SV8B) 3X Clock,  
AMD-5x86 3X Clock

3. Intel 80486DX/DX2, AMD Am486DX/DX2

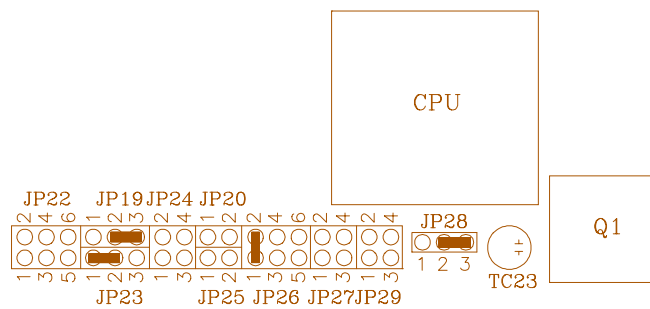

4. Intel 80487SX

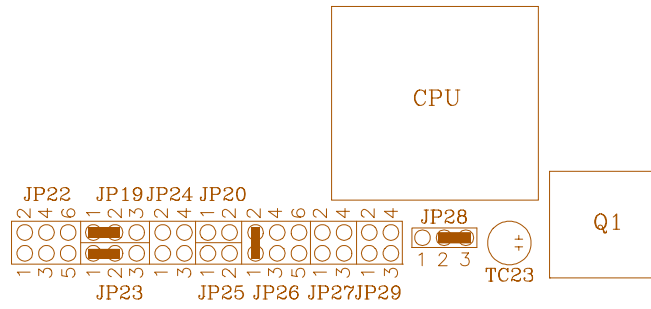

5. Intel 80486SX/SX2 (SL-Enhanced)

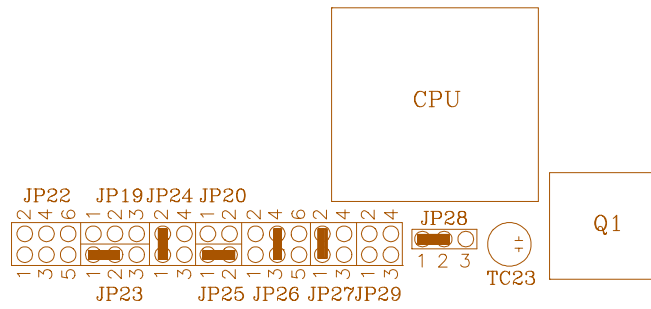

6. Intel 80486SX

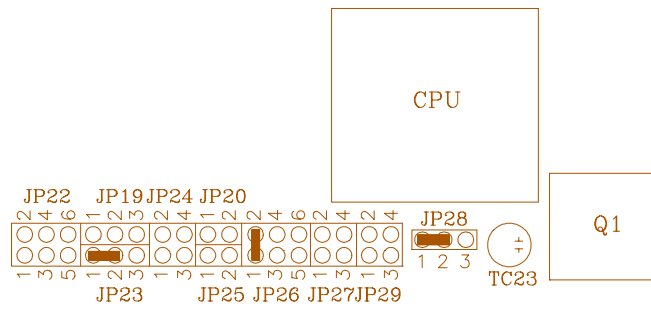

7. Intel P24T

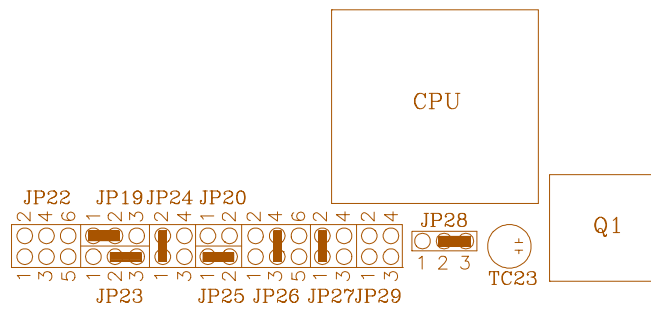

8. Cyrix 486DX/DX2/DX2-V/DX4-GP, TI486DX2, IBM 486-4V3100GC

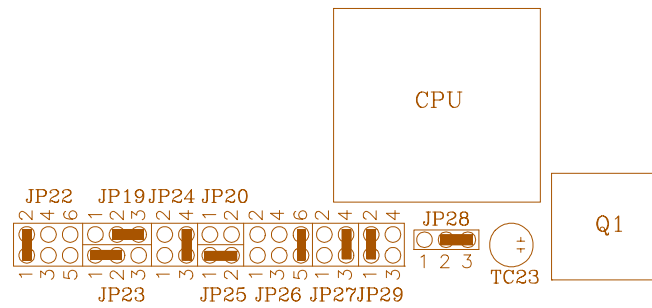

9. Cyrix Cx5X86, IBM 486-4V3100GIC

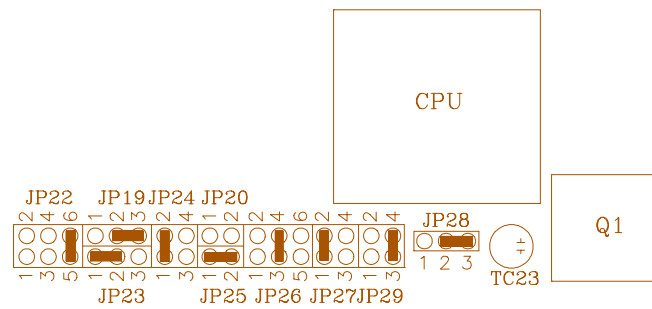

10. UMC U5S-SUPER

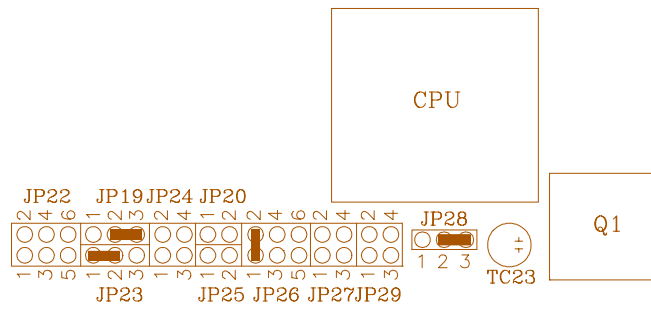

3.6.2 CPU CLOCK SELECTION

- 1. For 25MHz CPU Speed

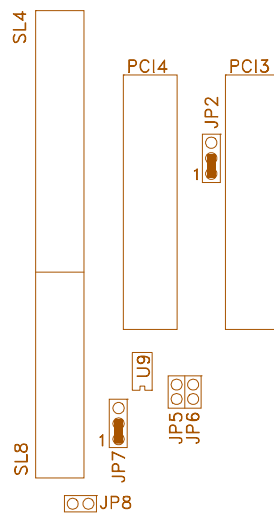

2. For 33MHz CPU Speed

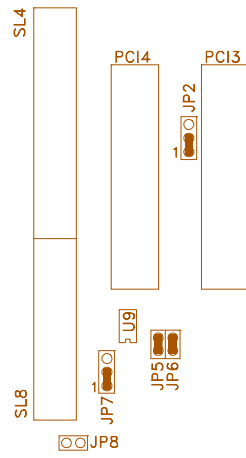

3. For 40MHz CPU Speed

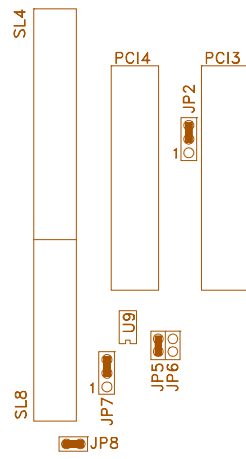

### 3.6.3 JP3 - CPU VOLTAGE SELECTION

JP3 is for the setting the CPU voltage selection.

1. 5 Volt

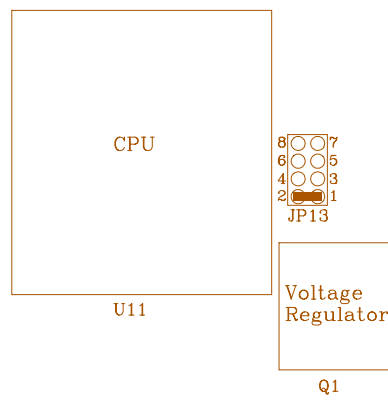

2. 3.3 Volt

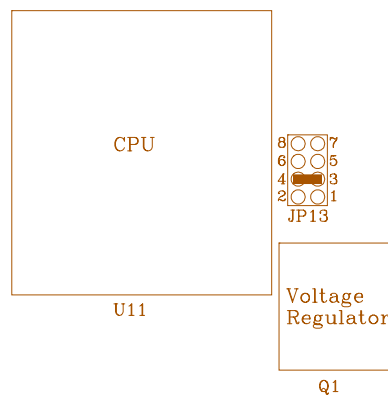



3. 3.45 Volt

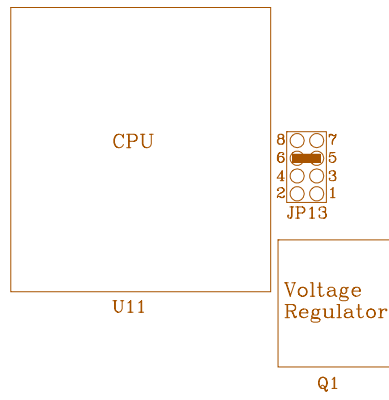

4. 3.6 Volt

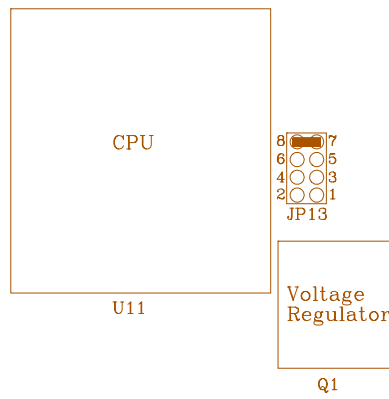

5. 4.0 Volt

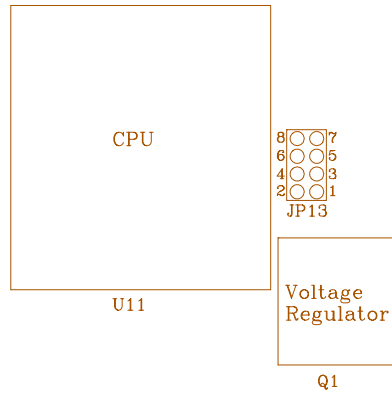

### 3.6.4 CACHE SIZE SETTING

1. 128KB (32Kx8) Cache Size

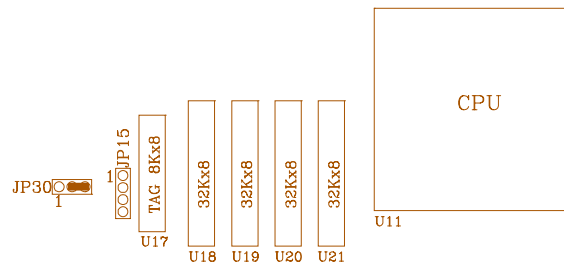

2. 256KB (64Kx8) Cache Size

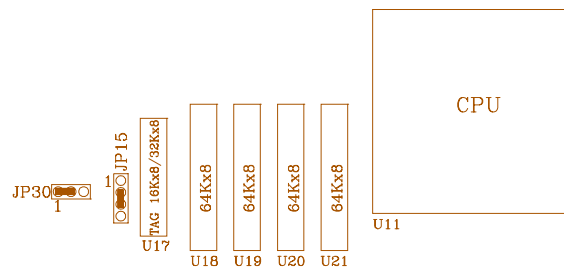

## 3. 512KB (128Kx8) Cache Size

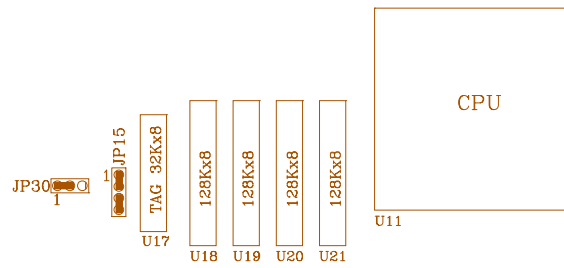

## 3.6.5 J1 - DISCHARGE CMOS RAM

J1 is used to clear the content stored on the CMOS RAM.

## 1. Normal

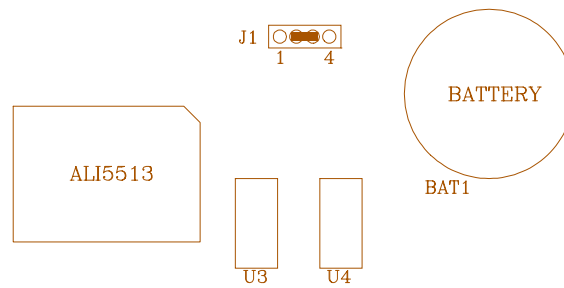

2. Reset Content of RTC

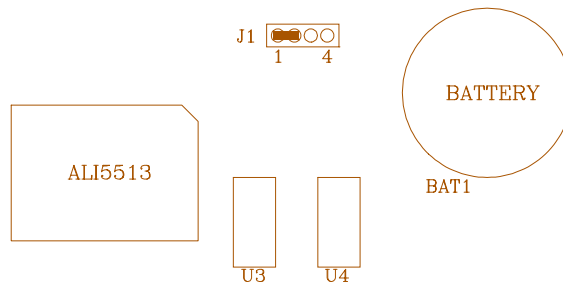

**3.6.6 JP9 - FLASH BIOS VOLTAGE SELECTION**

JP9 is for the Flash BIOS Voltage Selection.

1. 5V Flash BIOS and Standard EPROM

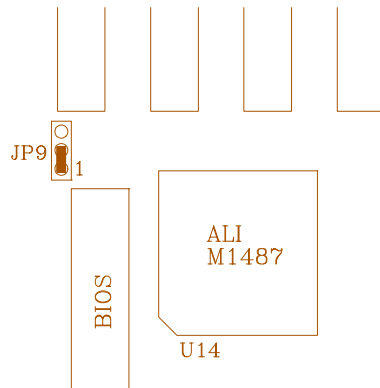

2. 12V Flash BIOS

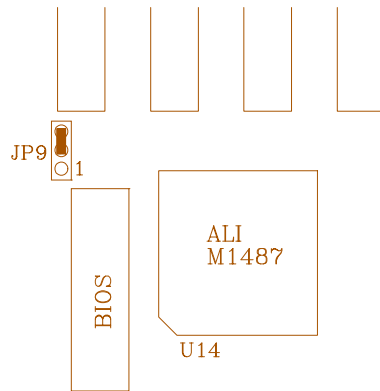



## 4.2 HARDWARE/SOFTWARE PCI IDE DRIVER INSTALLATION

- (1) Enter the correct disk parameters to the Standard CMOS Setup, or use the "IDE HDD AUTO DETECTION" feature on the CMOS SETUP UTILITY to let the BIOS to use the IDE hard disk parameters detected. (Refer to Section 5.10)
- (2) Set "On-Chip Local Bus IDE" option in "Chipset Features Setup" menu according to the IDE channel used (Refer to Section 5.4).
- (3) Install the PCI IDE Device Driver  
Please refer to the **README.NOW** file in PCI IDE Driver Diskette for detail installation procedures to be used in various kind of operating system (DOS, Windows95, Windows 3.1, Windows NT, OS/2, Novel 3.11).



---

## CHAPTER 5      AWARD BIOS SETUP GUIDE

This following manual is specially provided for the BIOS supported system. After the configuration of the mainboard, and have assembled the components, user can turn on the completed system. At this point, run the software setup to ensure that the system information is correct.

The software setup of the system board is achieved through Basic Input-Output System (BIOS) programming. Use the BIOS setup program to tell the operating system what type of devices (such as disk drives) are connected to the system board.

The system setup is also called CMOS setup. Normally, users need to run system setup if either the hardware configuration is not identical with information contained in the CMOS RAM, or the CMOS RAM has lost power.

### 5.1      AWARD BIOS SETUP

The setup program provided with the mainboard is the Award BIOS from Award Software, Inc. Enter the AWARD Setup program's Main Menu as follows:

1. Turn on or reboot the system. After a series of diagnostic check, the following message appear:

**"Press DEL to enter SETUP"**

2. Press the <DEL> key to enter the AWARD BIOS setup program and the following screen appears:

ROM PCI/ISA BIOS (2A4KDG3A)  
CMOS SETUP UTILITY  
AWARD SOFTWARE, INC.

STANDARD CMOS SETUP	SUPERVISOR PASSWORD
BIOS FEATURES SETUP	USER PASSWORD
CHIPSET FEATURES SETUP	IDE HDD AUTO DETECTION
POWER MANAGEMENT SETUP	HDD LOW LEVEL FORMAT
PCI CONFIGURATION SETUP	SAVE & EXIT SETUP
LOAD SETUP DEFAULTS	EXIT WITHOUT SAVING
Esc : Quit F10 : Save & Exit Setup	↑ ↓ → ← : Select Item (Shift)F2 : Change Color
{Description}	

3. Choose an option and press <Enter>. Modify the system parameters to reflect the options installed in the system. (see the following sections for more information).
4. Press <ESC> at anytime to return to the Main Menu.
5. In the Main Menu, choose "SAVE AND EXIT SETUP" to save change and reboot the system. Choosing "EXIT WITHOUT SAVING" to ignore all changes and exists the program.

## 5.2 STANDARD CMOS SETUP

Run the Standard CMOS Setup as follows.

1. Choose "STANDARD CMOS SETUP" from the Main Menu and a screen with a list of items appears.

ROM PCI/ISA BIOS (2A4KDG3A)  
STANDARD CMOS SETUP  
AWARD SOFTWARE, INC.

Date (mm:dd:yy) : Fri, Jan 6 1995	
Time (hh:mm:ss) : 15 : 17 : 49	
<hr/>	
HARD DISKS	TYPE SIZE CYLS HEAD PRECOMP LANDZ SECTOR MODE
<hr/>	
Primary Master : Auto	0 0 0 0 0 0 AUTO
Primary Slave : None	0 0 0 0 0 0 NORMAL
Secondary Master : None	0 0 0 0 0 0 NORMAL
Secondary Slave : None	0 0 0 0 0 0 NORMAL
<hr/>	
Drive A : 1.44M , 3.5in.	Base Memory: 640K
Drive B : None	Extended Memory: 3072K
Video : EGA/VGA	Other Memory: 384K
Halt On : All Errors	<hr/>
Total Memory:4096K	
<hr/>	
Esc : Quit    ↑↓ → ← : Select Item	PU/PD/+/- : Modify
F1 : Help    (Shift)F2 : Change Color	

2. Use the arrow keys to move between items and to select values. Modify the selected fields using the PgUp/PgDn key. Some fields let user enter numeric values directly.

**Date(mm/dd/yy)** Type the current date.

**Time(hh:mm:ss)** Type the current time.

**Drive C&D** Choose from the standard hard disk types 1 to 46. See Section 4.2, Type 47 is user definable. If a hard disk is not installed choose "None".

**Drive A&B** Choose 360K, 5.25 in.  
1.2M, 5.25 in.  
720K, 3.5 in.  
1.44M, 3.5 in.  
2.88MB 3.5 in. or  
None

**Video** Choose EGA/VGA,  
CGA 40,  
CGA 80, or  
MONO,

**Halt On** Choose All Errors  
No Errors,  
All, But Keyboard,  
All, But Diskette, or  
All, But Disk/Key

3. After user finished with the Standard CMOS Setup program, press the <ESC> key to go back to the main menu.

### 5.3 BIOS FEATURES SETUP

Run the Advanced CMOS Setup as follows.

1. Choose "BIOS FEATURES SETUP" from the Main Menu and a screen with a list of items appears.

ROM PCI/ISA BIOS (2A4KDG3A)  
BIOS FEATURES SETUP  
AWARD SOFTWARE, INC.

Virus Warning	: Disabled	Video BIOS Shadow	: Enabled
CPU Internal Cache	: Enabled	C8000-CFFFF Shadow:	Disabled
External Cache	: Enabled	D0000-D7FFF Shadow:	Disabled
Quick Power On Self Test	: Disabled	D8000-DFFFF Shadow:	Disabled
Boot Sequence	: A,C		
Swap Floppy Drive	: Disabled		
Boot Up Floppy Seek	: Enabled		
Boot Up Numlock Status	: On		
Boot Up System Speed	: High		
IDE HDD Block Mode	: Disabled		
Gate A20 Option	: Fast		
Typematic Rate Setting	: Disabled		
Typematic Rate (Chars/Sec)	: 6		
Typematic Delay (Msec)	: 250		
Security Option	: Setup		
PCI/VGA Palette Snoop	: Disabled		
		ESC: Quit    ↑↓→←: Select Item F1: Help    PU/PD/+/-: Modify F5: Old Values (Shift)F2: Color F7: Load Setup Defaults	

#### BIOS Setup Defaults

2. Use the arrow keys to move between items and to select values. Modify the selected fields by using the PgUp/PgDn keys. An explanation of the <F> keys follows:

<F1> "Help gives options available for each item.

(Shift)<F2> Change color.

<F5> Get the old values. These values are the values with which the user started the current session. If the CMOS was good, then the old values are either the CMOS values or the BIOS Setup default values.

<F6> Load all options in the BIOS Setup default values.

<F7> Load all options with the Power-On default values.

3. After user finished with the BIOS Features Setup program, press the <ESC> key to go back to the main menu.

**A short description of the screen items follows:**

**Virus Warning:** Enable Virus from invading the Boot area in either Hard Disk or Floppy Drive.

**CPU Internal Cache:** Choose Enabled or Disabled. This option lets user choose whether to use CPU internal cache memory. The default is Enabled.

**External Cache:** Choose Enabled or Disabled. This option lets user choose whether to use secondary cache memory. The default is Enabled.

**Quick Power On Self Test:** Choose Enabled or Disabled. This option let the POST sequence runs longer for through tests.

**Boot Sequence:** With the default setting the BIOS first attempts to boot from drive A: and then, if unsuccessful, from hard disk C:.. User can reverse this sequence with "C: A:", but then drive A: cannot boot directly.

**Swap Floppy Drive:** Choose Enabled or Disabled. This option lets end users to change the Drive A: or B: to others.

**Boot Up Floppy Seek:** Choose Enabled or Disabled. "Disabled" provides a fast boot and reduces the possibility of damage to the heads.

**Boot Up NumLock Status:** Choose On or Off. On puts numeric keypad in Num Lock mode at boot-up. Off puts numeric keypad in arrow key mode at boot-up.

**Boot Up System Speed:** Choose High or Low. Set the CPU timing at Boot Up, the default is high.

**Gate A20 Option:** Choose Fast or Slow. The system switch back an forth from real mode to virtue mode, fast means the system will switch through logic, slow through keyboard. The default is Fast.

**Typematic Rate Setting:** Choose Enabled or Disabled. Enabled will determines the typematic rate defined by following two options.

**Typematic Rate:** The number selected 6,8,10... indicates how fast the number of characters can response in one second.

**Typematic Delay (Msec):** The number selected indicates the time period between two identical keys appear.

**Security Option:** Choose Setup or System. If system is selected, the password should be set.

**PCI/VGA Palette Snoop:** Select Disabled or Enabled. If Enabled the MPEG Card can synchronised with PCI/VGA.

**Video BIOS Shadow:** ROM Shadow copies Video BIOS code from slower ROM to faster RAM. Video BIOS can then execute from RAM.

**C8000-CFFFF Shadow:** If enabled and BIOS is present in this segment, then a image of the slower ROM BIOS is created on the faster DRAM. The BIOS on this segment will be executed from the DRAM image.

**D0000-D7FFF Shadow:** If enabled and BIOS is present in this segment, then a image of the slower ROM BIOS is created on the faster DRAM. The BIOS on this segment will be executed from the DRAM image.

**D8000-DFFFF Shadow:** If enabled and BIOS is present in this segment, then a image of the slower ROM BIOS is created on the faster DRAM. The BIOS on this segment will be executed from the DRAM image.



## 5.4 CHIPSET FEATURES SETUP

The Advanced Chipset Setup option is used to change the values of the chipset registers. These registers control most of the system options in the computer.

*Note: Change these Settings only if user is familiar with the Chipset.*

Run the Advanced Chipset Setup as follows:

1. Choose "CHIPSET FEATURE SETUP" from the Main Menu and a screen with a list of items appears. Following is suggested setting:

ROM PCI/ISA BIOS (2A4KDG3A)  
CHIPSET FEATURES SETUP  
AWARD SOFTWARE, INC.

Auto Configuration	: Enabled	Onboard FDC Controller	: Enabled
AT-BUS Clock	: CLK/4	Onboard UART 1	: 3F8/IRQ 4
DRAM Read Timing	: Normal	UART 1 operation mode	: Standard
DRAM Write Timing	: Normal	Onboard UART 2	: 2F8/IRQ 3
SRAM Read Timing	: 2-1-1-1	UART 2 operation mode	: HPSIR
SRAM Write Timing	: 0 Wait	Onboard Parallel Port	: 378/IRQ 7
		Parallel Port Mode	: Normal
Hidden Refresh	: Disabled		
ISA I/O Recovery	: Enabled		
Fast-Back-to-Back	: Enabled		
On-Chip Local Bus IDE	: Enabled		
IDE Buffer for DOS & Win	: Enabled		
The 2nd channel IDE	: Enabled		
IDE HDD Block Mode	: Enabled		
IDE Primary Master PIO	: Auto		
IDE Primary Slave PIO	: Auto		
IDE Secondary Master PIO	: Auto		
IDE Secondary Slave PIO	: Auto		
		ESC: Quit    ↑↓→←: Select Item F1: Help    PU/PD/+/-: Modify F5: Old Values (Shift)F2: Color F7: Load Setup Defaults	

**A short description of the screen items follows:**

**Auto Configuration:** The default value of the following options in this menu will be different according to the CPU clock speed:

AT-BUS Clock  
 DRAM Read Timing  
 DRAM Write Timing  
 SRAM Read Timing  
 SRAM Write Timing

To enable the "Auto Configuration" option will let the system BIOS to detect the CPU clock speed, and it will use the pre-defined value for these options according to speed detected, and the corresponding setting will be protected from making change. It is strongly recommended to enable this option:

CPU Speed (MHz)	25/75	33/66	40/80/120	100/133
AT-Bus Clock	CLK/3	CLK/4	CLK/5	CLK/4
DRAM Read Timing	Normal	Normal	Normal	Normal
DRAM Write Timing	Normal	Normal	Normal	Normal
SRAM Read Timing	2-1-1-1	2-1-1-1	4-2-2-2	3-2-2-2
SRAM Write Timing	0 Wait	0 Wait	0 Wait	0 Wait

**AT-Bus Clock:** It is used to select the bus clock frequency of the ISA bus. The available options are "7.159MHz", "CLK/3", "CLK/4", "CLK/5", "CLK/6" and "CLK/8". It is set depending on the external CPU clock speed.

**DRAM Read Timing:** It is used to control the DRAM read cycle timing. The available options are "Slow", "Normal", "Fast" and "Faster". It is set depending on the CPU speed.

**DRAM Write Timing:** It is used to control the DRAM write cycle timing. The available options are "Slow", "Normal", "Fast" and "Faster". It is set depending on the CPU speed.

**SRAM Reading Timing:** It is used to control the level 2 cache burst read cycle timing. The available options are "2-1-1-1", "3-1-1-1", "3-2-2-2" and "4-2-2-2". It is set depending on the CPU speed.

**SRAM Write Timing:** It is used to control the level 2 cache write cycle timing. The available options are "0 wait", and "1 wait". It is set depending on the CPU speed.

**Hidden Refresh:** To enable this function will let the DRAM is refreshed without hold the CPU, so the system performance will increase.

**ISA I/O Recovery:** For some traditional slow respondent ISA I/O cards, extra I/O recovery time between two consecutive I/O access cycles is needed. To enable this function will increase the ISA bus I/O recovery cycles.

**Fast-Back-to-Back:** To enable the CPU to PCI write buffer fast-back-to-back feature for improving the CPU to PCI write performance.

**On-Chip Local Bus IDE:** To enable or disable the on board built-in PCI IDE controller.

**IDE Buffer for DOS & Win:** To enable the built-in PCI IDE buffers for improving the PCI IDE performance under DOS and Windows environment.

**IDE HDD Block Mode:** To enable the IDE hard disk block mode for improve the hard disk performance.

**IDE Primary Master PIO/IDE Primary Slave PIO/IDE Secondary Master PIO/IDE Secondary Slave PIO:** Available selection are "Auto", "Mode 0", "Mode 1", "Mode 2", "Mode 3" and "Mode 4". To choose "Auto", the system BIOS will scan the IDE device and decide which mode of the device is. Otherwise the user should key in the mode of the device into the corresponding field.

**Onboard FDC Controller:** To enable or disable the on board built-in floppy diskette drive controller.

**Onboard UART 1/Onboard UART 2:** Available options are "3F8/IRQ4", "2F8/IRQ3", "3E8/IRQ3" and "Disabled". They are used to configure the on board serial port 1 and port 2 to different port address or disable it. Make proper selection to avoid address conflict with other I/O devices.

**UART 1 operation mode/UART 2 operation mode:** Available options are "Standard", "HPSIR" and "ASKIR". They are used to configure the mode of operation of the on board serial port 1 and port 2:

- Standard - for standard RS-232 mode
- HPSIR - for Serial Infra Red mode
- ASKIR - for Amplitude Shift Keyed Infra Red mode

**Onboard Parallel Port:** Available options are "3BC/IRQ7", "278/IRQ5", "378/IRQ7", and "Disabled". They are used to configure the on board parallel port to different port address or disable it. Make proper selection to avoid address conflict with other I/O devices.

**Parallel Port Mode:** Available options are "Normal", "EPP", "ECP" and "ECP+EPP". It is used to configure the mode of operation of the on board parallel port:

- Normal - for standard printer port mode
- EPP - for Enhanced Parallel mode
- ECP - for Extended Capabilities Port mode
- ECP+EPP - for EPP or ECP mode

**ECP Mode DMA:** Available options are "3" and "1". It is used to select the DMA channel used for the on port parallel port in ECP mode.

**Parallel Port EPP Type:** Available options are "EPP1.9" and "EPP1.7". The on-board parallel port supports EPP Timing Specification Version 1.9 and Version 1.7. It is used to select the EPP timing specification.

## 5.5 POWER MANAGEMENT SETUP MENU

The Power Management Setup option is used to change the values of the chipset registers for system power management functions.

Run the Advanced Chipset Setup as follows:

1. Choose "POWER MANAGEMENT SETUP" from the Main Menu and a screen with a list of items appears.

ROM PCI/ISA BIOS (2A4KDG3A)  
POWER MANAGEMENT SETUP  
AWARD SOFTWARE, INC.

Power Management	: Max Saving	IRQ6 (Floppy Disk)	: ON
PM Control by APM	: Yes	IRQ7 (LPT 1)	: ON
Video Off Option	: Suspend->Off	IRQ8 (RTC Alarm)	: OFF
Video Off Method	: V/H SYNC+Blank	IRQ9 (IRQ2 Redir)	: ON
		IRQ10 (Reserved)	: OFF
<b>**PM Timers**</b>		IRQ11 (Reserved)	: OFF
HDD Power Down	: Disable	IRQ12 (PS/2 Mouse)	: ON
Suspend Mode	: 10 Sec	IRQ13 (Coprocesor)	: OFF
		IRQ14 (Hard Disk)	: ON
<b>**PM Events**</b>		IRQ15 (Reserved)	: OFF
VGA	: OFF		
FDD (3FXh)	: ON		
LPT & COM	: LPT/COM		
HDD (1FXh)	: ON		
NMI	: OFF		
IRQ3 (COM 2)	: ON		
IRQ4 (COM 1)	: ON		
IRQ5 (LPT 2)	: ON		
		ESC: Quit	↑↓→←: Select Item
		F1: Help	PU/PD/+/-: Modify
		F5: Old Values (Shift)	F2: Color
		F7: Load Setup Defaults	

**A short description of the screen items follows:**

**Power Management:** Available selection are "Disabled", "User Define", "Max Saving" and "Min Saving":

"Disable" will disable all the power saving functions.

"User Define" makes the time period waiting for Suspend Mode to be programmed.

"Max Saving" will set the time period waiting for Suspend Mode to be 20 seconds.

"Min Saving" will set the time period waiting for Suspend Mode to be 40 minutes.

**PM Control by APM:** Available options are "Yes" and "No". To choose "Yes" to let the Power Management Function to be control by the MS APM software.

**Video Off Option:** Available options are "Suspend->Off" and "Always On". To choose "Suspend->Off" option will make the video off during the Suspend Mode. "Always On" will keep the video on for all the modes.

**Video Off Method:** Choose V/H SYNC+Blank, DPMS or Blank Screen. This is monitor Power Saving Method. V/H SYNC+Blank means turn off Vertical, Horizontal scanning and blank the screen. Blank Screen will blank the display screen. DPMS (Display Power Management System) can allow the System BIOS control the Display Card to turn off the Display.

**HDD Power Down:** To select the time period will turn the HDD off. Accessing the HDD again will take a few seconds for HDD to spin up for operation.

**Suspend Mode:** To set the time period waiting for Suspend Mode when the Power Management function is set to "User Define".

**VGA/FDD (3FXh)/LPT & COM/HDD (1FXh)/NMI/IRQ3 - IRQ15:** All of these functions are used to control the wake up event from the Suspend Mode. Once the function is enabled, the corresponded activity will trigger the system back to the Normal Mode from the Suspend Mode.

## 5.6 PCI CONFIGURATION SETUP

The PCI & Onboard I/O Configuration Setup option is used to configure the PCI add-on Cards on PCI Slots and the onboard I/O chips. Without proper setup the PCI Add-on Cards might not function properly.

ROM PCI/ISA BIOS (2A4KDG3A)  
PCI & ONBOARD I/O CONFIGURATION SETUP  
AWARD SOFTWARE, INC.

PnP BIOS Auto-Config	: Enabled	CPU to PCI Write Buffer	: Enabled
Slot 1 Using INT#	: AUTO	CPU to PCI Byte Merge	: Enabled
Slot 2 Using INT#	: AUTO	PCI to DRAM Buffer	: Enabled
Slot 3 Using INT#	: AUTO		
Slot 4 Using INT#	: AUTO		
PCI IRQ Activated By	: Level		
PCI IDE 2nd Channel	: Enabled		
PCI IDE IRQ Map To	: PCI-AUTO		
Primary IDE INT#	: A		
Secondary IDE INT#	: B		
		ESC: Quit    ↑↓→←: Select Item	
		F1: Help    PU/PD/+/-: Modify	
		F5: Old Values (Shift)F2: Color	
		F7: Load Setup Defaults	

**A short description of the screen items follows:**

**PnP BIOS Auto-Config:** To enabled this function will make the system BIOS to assign the IRQ automatically. If this function is disabled, the following options will be shown:

- 1st Available IRQ
- 2nd Available IRQ
- 3rd Available IRQ
- 4th Available IRQ

The user should assign the IRQ manually.

**Slot 1 Using INT#/Slot 2 Using INT#/Slot 3 Using INT#/Slot 4 Using INT#:**

Available Selections are "AUTO", "A", "B", "C" and "D". To select "AUTO", the system BIOS will assign the INT# for the PCI Slot automatically. Otherwise, the user should key in the INT# for the PCI Slot used manually.

**PCI IRQ Activated By:** Available selection are "Level" and "Edge", it is used to define the trigger mode of the PCI IRQ.

**PCI IDE 2nd Channel:** It is used to enable or disable the IRQ15 used by the secondary channel of the on board PCI IDE controller.

**PCI IDE IRQ Map to:** Available selection are "PCI-AUTO" and "ISA". To select "PCI-AUTO" will make the system BIOS to scan for PCI devices and determine the location of the PCI IDE device. It will assign INT#A for the primary IDE, and INT#B for secondary IDE. To select "ISA" will make the BIOS not to assign any IRQs for the PCI IDE controller.

**CPU to PCI Write Buffer:** To enable the CPU to PCI Write Buffer for improving the PCI bus performance.

**CPU to PCI Byte Merge:** To enable the CPU to PCI Byte Merge feature will increase the PCI bus performance.

**PCI to DRAM Buffer:** To enable the PCI to DRAM Buffer will increase the PCI bus performance.



## **5.7 LOAD SETUP DEFAULTS MENU**

This Main Menu item uses the default setup values. Use this option as a diagnostic aid if the system behaves erratically. Choose this item and the following message appears:

**"Load SETUP Defaults (Y/N)? N"**

To use the Power-On defaults, change the prompt to "Y" and press <Enter>.

## **5.8 SUPERVISOR PASSWORD**

Two level of password is supported. Depending on the setting of the "Security Option" in the "BIOS FEATURES SETUP", the system BIOS will ask for password every time booting up the System or entering BIOS Setup. With the supervisor password, both the system booting and BIOS setup changing is allowed.

This main menu item lets the user to set up the Supervisor Password.

Change the password as follows:

1. Choose "PASSWORD SETTING" in the Main Menu and press <Enter>. The following message appears:

**"ENTER PASSWORD:"**

2. Enter the Password and press <Enter>. The following message appears:

**"CONFIRM PASSWORD:"**

*Important: Keep a safe record of the new password. If forget or lose the password, the only way to access the system is to disconnect the CMOS batteries and then re-enter the password.*

## 5.9 USER PASSWORD

With the user password, only booting up the system is accepted, but changing the BIOS setup is not allowed.

## 5.10 IDE HDD AUTO DETECTION

When users can not find the Hard Disk information, it is very helpful to use his option.

1. Choose this item and press <Enter>.
2. After couple seconds, the screen will appear the Hard Disk information and following message:

**"SELECT PRIMARY MASTER OPTION(N=SKIP): N"**

3. Enter Y or N to confirm the acceptance then enter.
4. The process will repeat for Primary Slave, Secondary Master and Secondary Slave Hard Disks.







## 5.12 SCSI HARD DISK INSTALLATION

In Standard CMOS Setup Utility, select hard disk type to be "Not Installed". In Advanced CMOS Setup Utility, Disable "Adapter ROM Shadow DC00". On the SCSI Controller card, set the jumpers which configure the SCSI card BIOS segment address located at DC00 or DE00. Format the SCSI disk by the Formatter provided in the SCSI BIOS.

## 5.13 SAVE & EXIT SETUP MENU

When you select this function, the following message will appear at the centre of the screen to assist you to Save data to CMOS and Exit the Setup.

**SAVE to CMOS and EXIT (Y/N)?**

## 5.14 EXIT WITHOUT SAVING MENU

When you select this function, the following message will appear at the centre of the screen to assist you to Abandon all Data and Exit Setup.

**Quit Without Saving (Y/N)?**