

**Panasonic**

**Laser Printer**

Model No. **KX-P6100**

*Operating Instructions*



Please read these instructions completely before operating this unit. Store this manual with care.

**Caution:** This product utilizes a laser.  
Use of control or adjustments or performance of procedures other than those specified herein may result in hazardous radiation exposure.  
Do not open covers and do not repair yourself. Refer servicing to qualified personnel.

When you operate this equipment, the socket outlet should be near the equipment and be easily accessible.

**Warning:** The power source voltage of this unit is listed on the nameplate. Plug the printer only into an outlet with the proper voltage. To prevent fire or shock hazard, do not expose this product to rain or any type of moisture.

The serial number of the unit may be found on the label on the rear of the unit. For your convenience, note this number below and retain this book along with your proof of purchase, to serve as a permanent record of your purchase in the event of a theft or for future reference.

MODEL NO.   KX-P6100        NAME OF DEALER \_\_\_\_\_  
SERIAL NO. \_\_\_\_\_      DATE OF PURCHASE \_\_\_\_\_

HP and LaserJet are trademarks of Hewlett-Packard Company.  
IBM and IBM PC are trademarks of International Business Machines Corporation.  
Microsoft, MS-DOS and Windows are trademarks of Microsoft Corporation.  
TrueType is a trademark of Apple Computer, Inc.  
Intel is a trademark of Intel Corporation.  
CompuServe is a trademark of CompuServe, Inc.  
Centronics is a trademark of Centronics Data Computer Corporation.  
Paintbrush is a trademark of ZSoft Corporation.  
PageMaker is a trademark of Aldus Corporation.  
CorelDRAW is a trademark of Corel Corporation.



As an Energy Star Partner Panasonic has determined that this product meets the Energy Star guidelines for energy efficiency.

All other acknowledgements are trademarks or registered trademarks of their respective holders.

All Rights Reserved. © COPYRIGHT 1994 KYUSHU MATSUSHITA ELECTRIC CO., LTD.

Any details given in these Operating Instructions are subject to change without notice.

## Laser Caution Label

**DANGER**-invisible laser radiation when open and interlock defeated.  
AVOID DIRECT EXPOSURE TO BEAM.

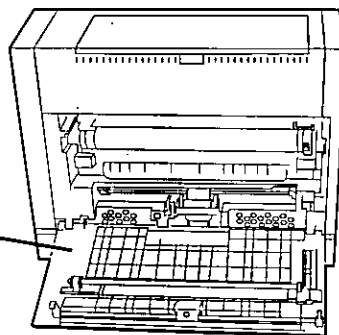

## FOR USERS IN UNITED STATES

This equipment has been tested and found to comply with the limits for a Class B digital device, pursuant to Part 15 of the FCC Rules. These limits are designed to provide reasonable protection against harmful interference in a residential installation.

This equipment generates, uses and can radiate radio frequency energy and, if not installed and used in accordance with the instructions, may cause harmful interference to radio communications.

However, there is no guarantee that interference will not occur in a particular installation. If this equipment does cause harmful interference to radio or television reception, which can be determined by turning the equipment off and on, the user is encouraged to try to correct the interference by one or more of the following measures:

Reorient or relocate the receiving antenna.

Increase the separation between the equipment and receiver.

Connect the equipment into an outlet on a circuit different from that to which the receiver is connected.

Consult the dealer or an experienced radio/TV technician for help.

The user may find the booklet "Something About Interference" available from FCC local regional offices helpful.

**FCC Warning:** To assure continued FCC emission limit compliance, the user must use the recommended shielded interfacing cable when connecting to a host computer. Also, any unauthorized changes or modifications to this equipment would void the users authority to operate this device.

## Technical Support Calls

If you have read this manual and tried the troubleshooting procedures and you are still having difficulty please contact the store from which the unit was purchased.

You may also call the end user technical support telephone number which is operational during east coast business hours (9:00 AM to 5:00 PM).

The end user technical support number is 1-800-222-0584.

This number is available within the U.S. only.

## Helpful Phone Numbers

To locate your nearest sales dealer

To order consumables

To order operating instructions/manuals

To locate your nearest authorized service center

For technical support

CALL 1-800-742-8086

CALL 1-800-222-0584

CALL 1-206-395-7343

CALL 1-800-222-0584

CALL 1-800-222-0584

# Table of Contents

---

## Chapter 1 *Before You Start*

---

<b>Printer Features</b> . . . . .	<b>6</b>
<b>Cautions</b> . . . . .	<b>7</b>
Operating Environmen	7
Precautions	7
Minimum Space Requirements	8
Power Source	8
<b>System Requirements</b> . . . . .	<b>8</b>
<b>Unpacking</b> . . . . .	<b>8</b>
<b>Part Names</b> . . . . .	<b>9</b>
Left Side View	9
Right Side View	9
Indicators	9

## Chapter 2 *Setup — QUICK START*

---

<b>Preparation</b> . . . . .	<b>10</b>
Printer Stands Installation . . . . .	10
Process Unit Installation . . . . .	10
Connecting the Printer and Power On . . . . .	11
<b>Loading Paper / Envelopes (Labels, Transparencies)</b> . . . . .	<b>12</b>
Loading Paper . . . . .	12
Loading Envelopes (Labels, Transparencies) . . . . .	13
<b>Allocating Virtual Memory</b> . . . . .	<b>14</b>
<b>Installing the KX-P6100 Software</b> . . . . .	<b>14</b>
<b>Testing the Printer</b> . . . . .	<b>15</b>
<b>Removing the KX-P6100 Software</b> . . . . .	<b>16</b>

## Chapter 3 *Print Modes*

---

<b>Print Mode Selections</b> . . . . .	<b>17</b>
Printing From a Windows Application	17
Printing From a DOS Application Within Windows	17
Changing the Print Mode	17
<b>KX-P6100 GDI Mode</b> . . . . .	<b>18</b>
Using Overlay	20
Using Image	23
Using 2 Up/4 Up	23
<b>KX-P6100 PCL Mode</b> . . . . .	<b>24</b>
PCL Control Panel	24

---

**Chapter 4**      ***KX-P6100 Print Manager***

---

Queue Information . . . . .	26
File Menu . . . . .	27
Options Menu . . . . .	27
Size Menu . . . . .	27

---

**Chapter 5**      ***KX-P6100 Status Display***

---

File Menu . . . . .	28
Options Menu . . . . .	28
Setup Menu . . . . .	29
Printer Problem Status Messages . . . . .	30

---

**Chapter 6**      ***Care and Maintenance***

---

Cleaning the Printer . . . . .	31
Outside of the Printer . . . . .	31
Inside of the Printer . . . . .	31
Troubleshooting . . . . .	32
Repacking Instructions . . . . .	33

---

**Appendix**

---

Supplies . . . . .	35
Refilling the Toner in the Process Unit . . . . .	35
Printer Specifications . . . . .	36
Paper Specifications . . . . .	37
Paper Specifications . . . . .	37
Paper and Envelope Sizes . . . . .	37
Types of Paper to Avoid . . . . .	38
Two-sided Printing . . . . .	38
Printing OHP Transparencies and Labels . . . . .	38
Envelope Specifications . . . . .	39
Interface Specifications . . . . .	40
Bi-directional Parallel Interface . . . . .	40
Index . . . . .	41

Chapter 1

Chapter 2

Chapter 3

Chapter 4

Chapter 5

Chapter 6

Appendix





# Chapter 1 Before You Start

## Printer Features

Congratulations on your purchase of the KX-P6100. We are sure it will meet your printing needs and give you many years of productive and efficient use.

### ■ GDI Mode ( P. 18)

GDI Mode takes advantage of Windows' own internal design to print documents four to five times faster than most conventional printers can. Other printers require Windows to translate a document into a special printer language, such as PCL on LaserJet printers. GDI Mode reduces overhead by eliminating this translation step before starting to print. This mode includes the following special features.

- Top Page:** Prints your document in reverse order (  P. 19).
- Manual Duplex Printing:** Prints your document on both sides of the paper (  P. 19).
- Overlay:** Overlays an image over any document (  P. 19).
- 2 Up/4 Up:** Prints 2 or 4 pages on a single sheet of paper to save paper (  P. 19).
- Photo Enhancement:** Improves the quality of the image output (  P. 23).

### ■ PCL Mode ( P. 24)

Enables you to print a file created with the MS-DOS application or to print a PCL format file.

### ■ KX-P6100 Software

- enables you to set up the printer
- displays the printer status
- displays the recovery instructions when a problem occurs
- manages all output to the printer
- provides help system

### ■ Toner Saving ( P. 29)

With TonrSavR turned on, your printer reduces the amount of toner used to print the output. This feature is useful for printing drafts before the final print to save toner.

### ■ Edge Enhancement Technology (EET) ( P. 29)

With Edge Enhancement turned on, your printer smooths the jagged edges of text and line art.

### ■ Power Saving ( P. 29)

Saves energy while the printer is idle.

### ■ Animated Help Feature ( P. 30)

The KX-P6100 Status Display alerts you in case of a problem. Click the Show Me button for animated help. This feature will walk you through the steps required to get your printer running once again.

### ■ Bidirectional Parallel Interface

(  P. 40)

Enables communication between the computer and the printer.

**Cautions**

**Operating Environment**

Do not use the printer under the following conditions to avoid the machine trouble

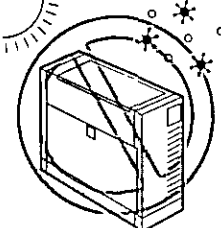

- Direct exposure to sunlight
- Extremely high or low temperature
- Extremely high or low humidity (humidity range 20% to 80% RH)

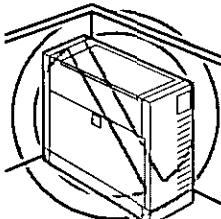

- Areas of poor ventilation

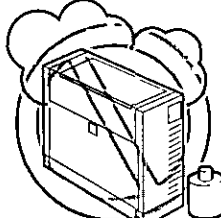

- Areas of high dust or chemical fume concentration (thinner etc)

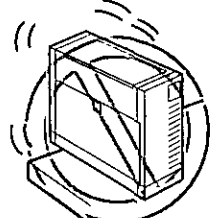

- Unstable or unlevel surfaces

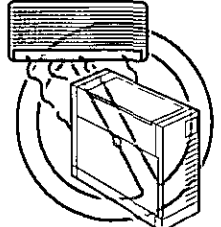

- Directly in front of air conditioning vents

**Precautions**

The following precautions are recommended to extend the life of the printer

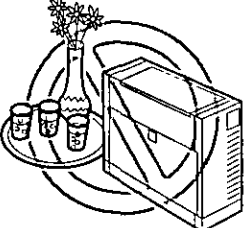

- Do not keep any liquids near the printer  
— Accidental spillage of a liquid into the printer can cause severe damage

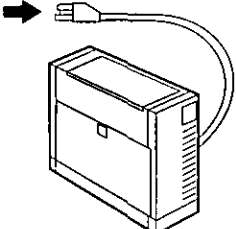

- If the printer is not going to be used for an extended period, unplug the power cord

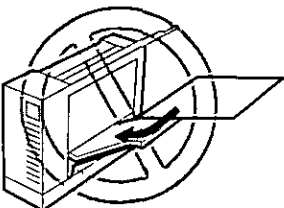

- Do not add paper to the tray until it is empty, since it may cause a paper jam

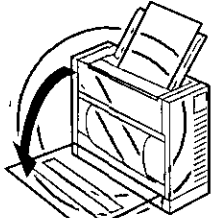

- Do not open the left cover while the printer is operating to avoid a paper jam

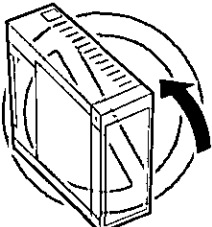

- Do not place the printer either on its left or right side or on its front side facing upward

## Before You Start

### Minimum Space Requirements

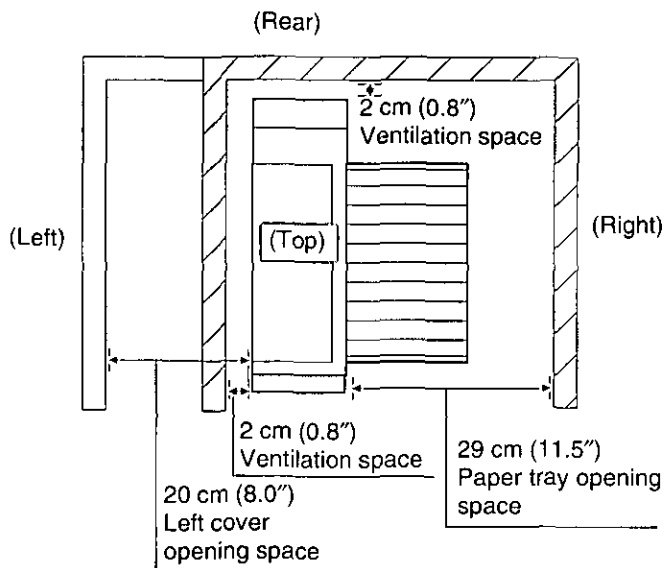

### Power Source

The voltage level of the power source must not vary more than  $\pm 10\%$  from the voltage level marked on the nameplate (located on the rear of the printer).

- Do not use an extension cord.
- This printer should be connected to a grounded outlet.
- Do not use a line conditioner, transient suppressor or surge protector as it may cause a machine error.

### System Requirements

To run the KX-P6100 Software, you need the following hardware and software.

#### Hardware requirements:

- IBM compatible PC with at least a 386SX 16MHz\* CPU that can run in Windows Enhanced Mode
  - At least 4 MB PC memory (RAM)
  - More than 4 MB hard disk space
  - PC with a standard parallel printer port (bi-directional)
- \* Some older 386s cannot run in Windows Enhanced Mode. If you have Windows installed on your PC, you can verify whether it runs in Enhanced Mode by typing WIN /3 at the MS-DOS prompt.

#### Software requirements:

- Windows 3.1 or later
- MS-DOS 3.3 or later
- Permanent virtual memory up to approximately 8.5 MB (  Allocating Virtual Memory on Page 14) [The total memory, PC RAM plus Virtual memory, should add up to at least 12.5 MB]

### Unpacking

After unpacking the printer, make sure none of the items shown below are missing or damaged. Report damage or shortages to the store from which the unit was purchased. Inside the front cover of this manual is an area for recording important information such as the serial number, date of purchase and your dealer name.

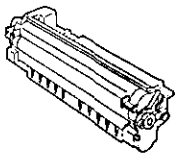

**Process Unit**  
(KX-PEP2) (  P. 10)  
(enclosed in the printer)



**Power Cord**  
(  P. 11)



**Software Disks**  
(  P. 14)

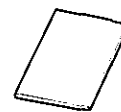

**Manual**

#### Note:

- It is recommended that you save the original carton and packing materials for proper shipping and transporting of the printer. They have been specifically designed to protect your printer during shipment.



Part Names

Left Side View

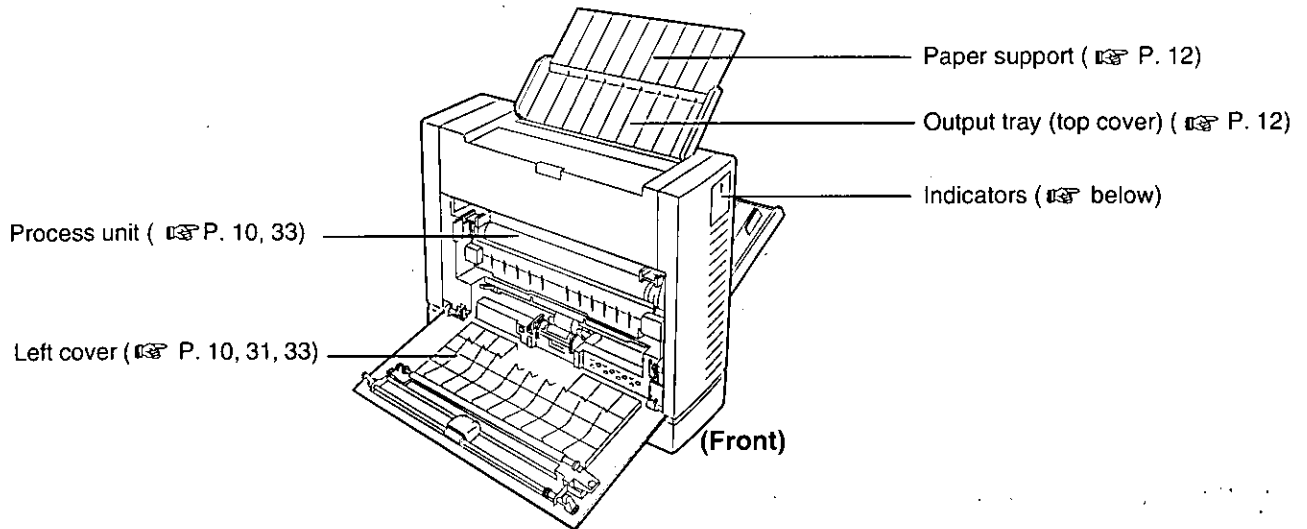

Right Side View

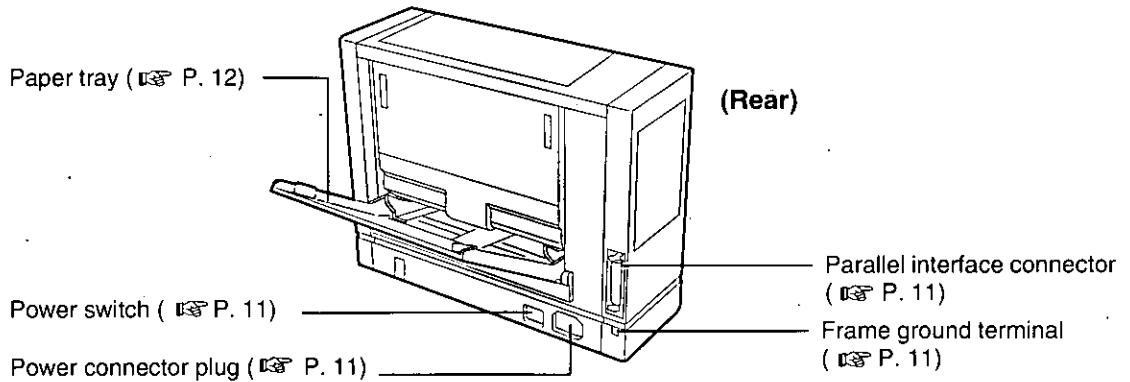

Indicators

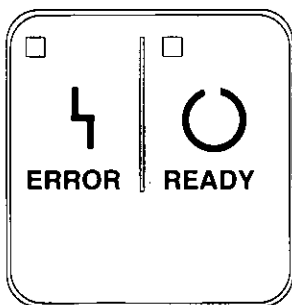

- on      ⬇️ blinking (fast)
- off     ⬇️ blinking (slow)

Indicators		Printer status
⚡	○	
□	⬇️	Warming up
□	■	Ready for printing, receiving/processing data
□	⬇️	Power Saving Mode: In the ready status, the printer has not received any data for 15 minutes
■	□	Internal error: Turn the power off, then on again. If the error continues, service by an Authorized Panasonic Service Center is required.
⬇️	□	Paper jam, process unit missing, door open, paper out
⬇️	■	Change process unit

# Chapter 2 Setup

## Preparation

### Printer Stands Installation

- 1 **1** Lift the printer by holding its front side and remove both the printer stands by firmly sliding them downward.
- 2 Turn both the printer stands around and install them into the printer.

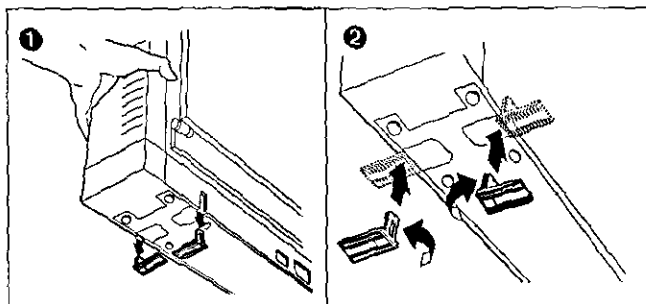

### Process Unit Installation

#### Important:

To prevent any damage to the Process Unit, observe the following cautions.

- Do not touch the green drum surface. Lift the Process Unit by tabs.
- Do not expose the Process Unit to light for more than 5 minutes.
- Do not keep the Process Unit near dust or dirt.
- Do not place the Process Unit in a high humidity area and keep it out of direct sunlight.

- 1 Open the left cover by gently pulling the cover release tab.

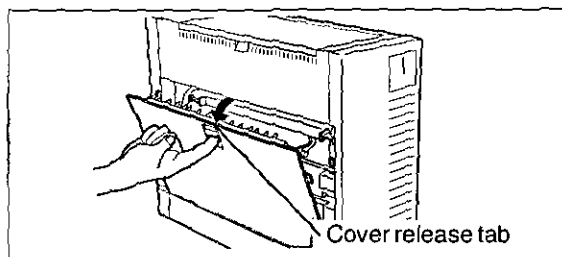

- 2 Remove the Process Unit by holding the green labeled tabs and pulling it toward you.

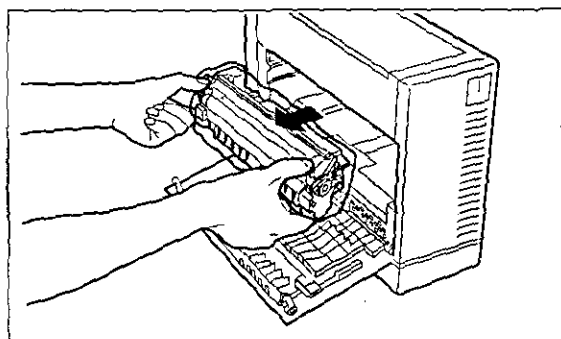

- 3 Open the plastic bag and take out the Process Unit.

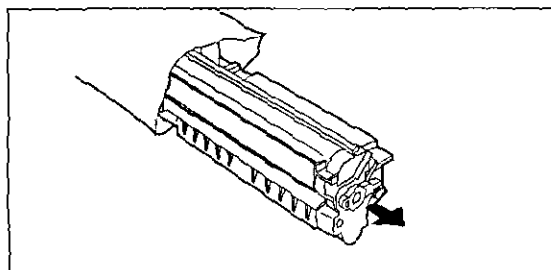

- 4 **1** Remove the sealing film.  
**2** Remove the protective sheet.

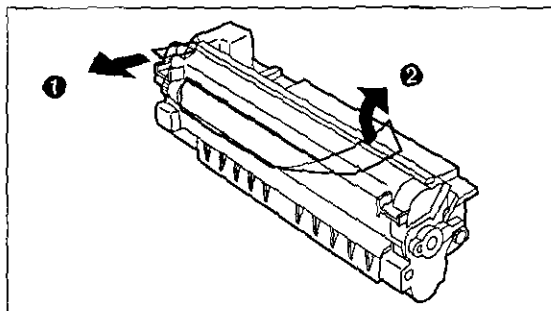

- 5 Replace the Process Unit by holding the tabs and pushing it firmly into the printer.

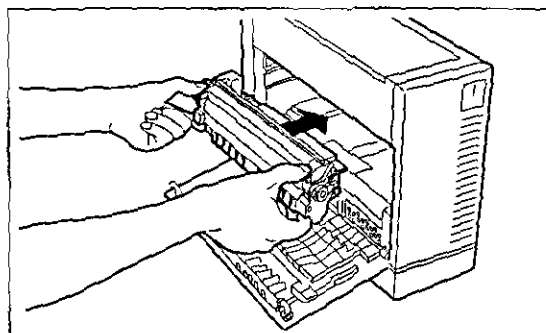

**6** Close the left cover**Notes:**

- PLEASE DO NOT THROW AWAY THE PACKING MATERIALS YOU MAY NEED THEM TO SHIP OR TRANSPORT THE PRINTER
- TO PROVIDE OPTIMUM PRINT QUALITY THE UNIT MUST BE UPRIGHT AND KEPT LEVEL AT ALL TIMES

**Connecting the Printer and Power On**

This printer is equipped with bidirectional parallel interface. If you do not have an interface cable, you will need to purchase one from your local computer store or dealer.

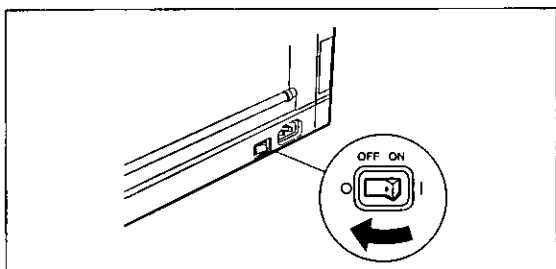
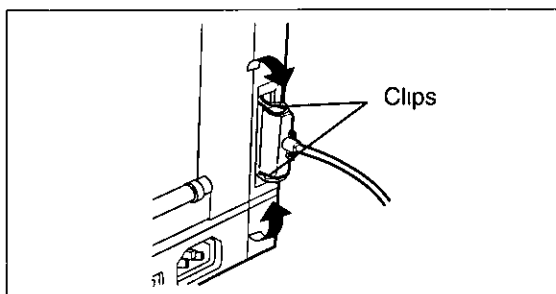
**1** Turn OFF both the printer and computer power switches.**2** Plug one end of the cable into the parallel interface connector of the printer. Snap the clips into place.

If the cable has a frame ground wire, connect it to the frame ground terminal.

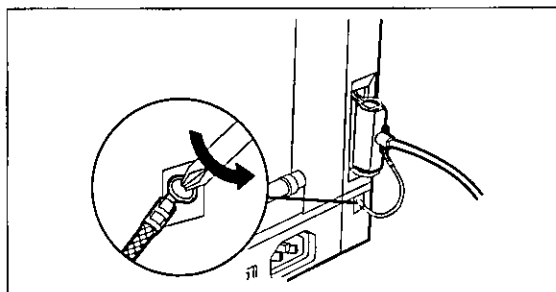
**3** Plug the other end of the cable into the connector at the computer.**Note:**

- The actual connector on the computer may differ depending on the manufacturer of the computer.

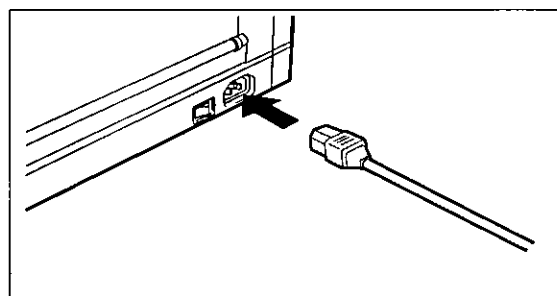
**4** Connect the power cord into the printer's power connector plug.**5** Plug the power cord into a 3-prong AC wall socket.**6** Turn ON both the printer and computer power switches.**7** The printer is warming up  
The READY indicator is blinking fast.**8** The printer is ready for printing  
The READY indicator is on.

# Setup

## Loading Paper/Envelopes (Labels, Transparencies)

### Loading Paper

This printer has a multi-purpose paper tray.

The paper size selected through the GDI Mode ( P. 18), PCL Mode ( P. 24), or software application should match the size of the paper in the paper tray. If the selected paper size is different, a paper jam may occur.

- 1 **Open the output tray (top cover).**
  - 2 Extend the paper support by sliding it upward.

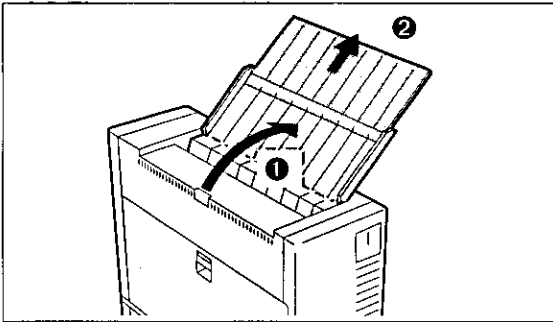

- 2 **Open the paper tray.**

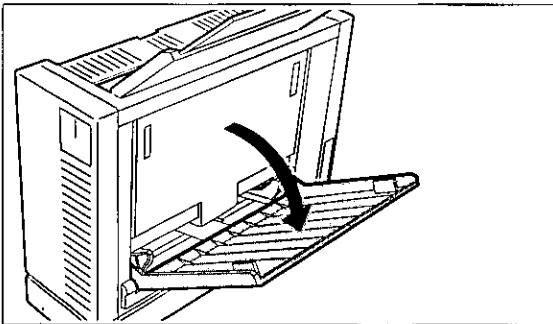

- 3 **Separate the paper guides to the approximate width of your paper.**  
Refer to the size indicators above the paper guides for accurate paper width.

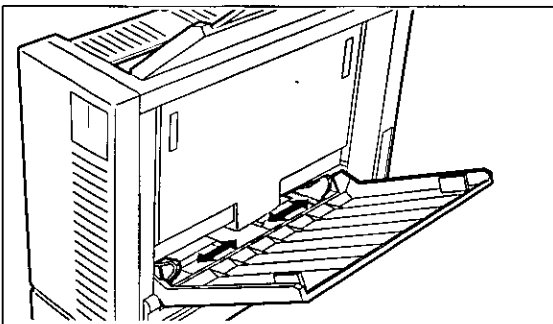

- 4 **Fan the stack of paper and tap it on a level surface to avoid a paper jam or skewed printing.**

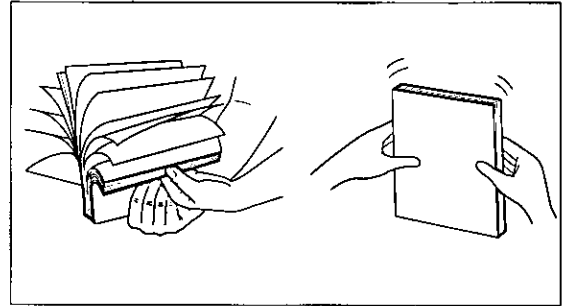

#### Note:

- You may load up to 100 sheets of 75 g/m<sup>2</sup> (20 lbs.) paper in the paper tray.

- 5 **Place the paper in the paper tray properly and adjust the paper guides to your paper size.**

The height of paper should not exceed limit mark on the paper guide, since it may cause a paper jam.

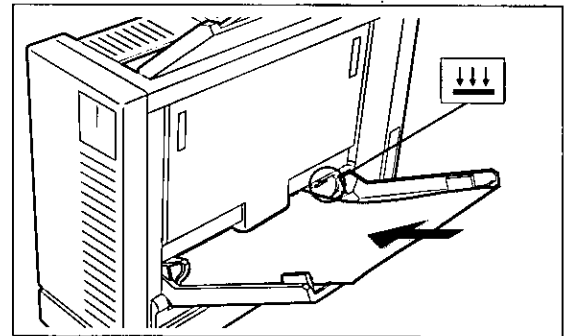

**Notes:**

- If the paper guides are not adjusted properly, your printout may be skewed.
- Do not load paper of different types or thicknesses in the paper tray at one time, since this may cause a paper jam.
- When you want to add more paper to the paper tray, you must first remove the remaining paper from the tray and then place the entire stack of paper into the tray.
- Make sure you load the paper with the print side up. Most paper has instructions recommending the side to be printed first. When using 60 g/m<sup>2</sup> (16 lbs.) paper, always load the paper with the “non-curl side” up rather than following instructions on the paper package.
- For more detailed information on paper, refer to “Paper Specifications” ( P. 37).
- Do not allow more than 50 sheets [75 g/m<sup>2</sup> (20 lbs.)] to accumulate in the output tray. This may cause a paper jam.

**Loading Envelopes (Labels, Transparencies)**

You may load either 30 sheets of labels, 30 transparencies, or up to 10 envelopes in the paper tray. You can use Business Commercial #10, Monarch, International DL and International C5 envelopes. For more detailed information on Envelopes, refer to “Envelope Specifications” ( P. 39).

**Notes:**

- Before loading envelopes, make sure that all seams are properly sealed to avoid turning over of the seams.
- The envelopes must be installed with the shorter edges first to avoid a paper jam.
- When installing envelopes, the flaps should be face down.
- To print lengthwise on the envelope (along the longer edge), set the printing mode to landscape ( P. 18, 24).

**1** Perform steps 1 and 2 on page 12.

**2** Adjust the paper guides to the approximate width of your envelope.

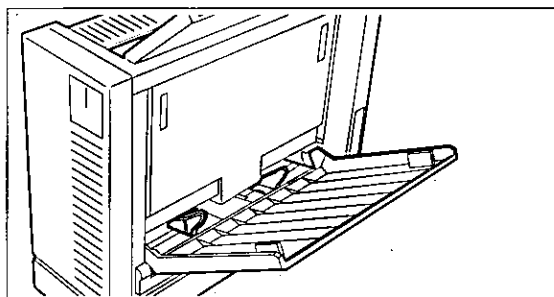

**3** Place the envelopes in the paper tray with the sides to be printed facing up. Position them between the paper guides and adjust the guides until you feel resistance.

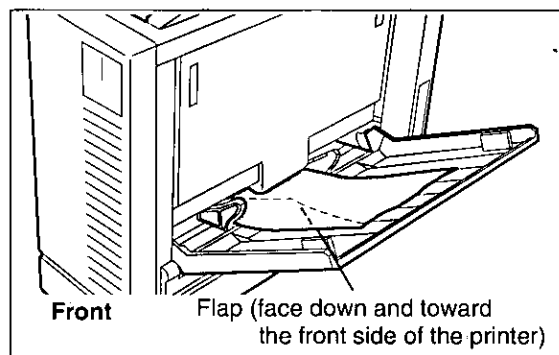

**4** Verify that your envelope matches the paper size set through the GDI Mode ( P. 18), PCL Mode ( P. 24), or software application to avoid a paper jam.

### Allocating Virtual Memory

KX-P6100 software requires 12.5 MB of total memory, divided between your PC memory (a minimum of 4 MB) and your Windows virtual memory. If your system has 4 MB of PC RAM, then you must allocate at least 8.5 MB of virtual memory. If you have 5 MB of RAM, then you need at least 7.5 MB of virtual memory, and so on.

To change the virtual memory, follow the instructions below. For more information on virtual memory, refer to the Optimizing Windows section in the Microsoft Windows 3.1 User's Guide.

The following instructions assume your system has 4 MB of PC RAM.

- 1 Double click the *Main* icon from the Program Manager screen.
- 2 Double click the *Control Panel* icon.
- 3 Double click the *386 Enhanced* icon.
- 4 Click  .  
Virtual Memory dialog box will be displayed.
- 5 If the size shown in the Virtual Memory dialog box is less than 8,500 KB, or Type is temporary or none, then click  .  
Otherwise click  to exit the dialog box.
- 6 Increase the New size in the New Settings box to at least 8,500 KB.
- 7 Select the Type "Permanent" in the New Settings box.
- 8 Click  .
- 9 Click  .
- 10 Click  to make the setting effective.

### Installing the KX-P6100 Software

To install the KX-P6100 software onto your hard disk, follow the instructions below.

- 1 At the DOS prompt, type WIN and press  to start Windows in the 386 Enhanced Mode.  
  
On some PCs, you need to type WIN/3 at the DOS prompt to set 386 Enhanced Mode.
- 2 From the Program Manager menu, click File. Then click the Run... option.
- 3 Insert the KX-P6100 software disk #1 into disk drive A.
- 4 At the prompt, type A:\SETUP.EXE and click  .
- 5 Click the mouse or press any key to continue.
- 6 Click the button of the parallel port which you wish to use, then click  .
- 7 If you wish to install the KX-P6100 software on default drive (C) and directory (KXP6100), click  .
  - If you wish to install the KX-P6100 software on another drive and/or directory, type the letter of the drive and/or directory name. Then click  .

**8** Remove disk #1 and insert the KX-P6100 software disk #2 into the same drive

**9** Click **OK**.

**10** Click **OK**.

Panasonic KX-P6100 Tools is created

**11** Click **OK**.

**12** Click **Restart Windows** to restart Windows.

**13** Click **OK**.

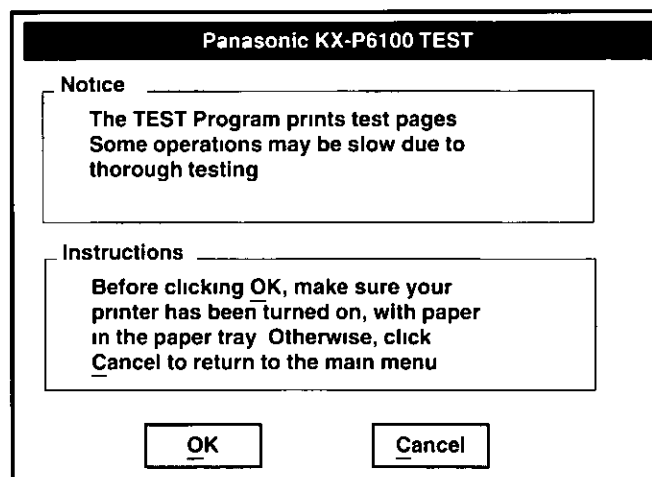

- If you want to test the printer, go to step 3 of “Testing the Printer” below

## Testing the Printer

You can test the connection between the PC and printer and view additional information about your PC and printer by running the Test program

**1** If **Panasonic KX-P6100 Tools** has been minimized, restore it by double clicking the **Tools icon**

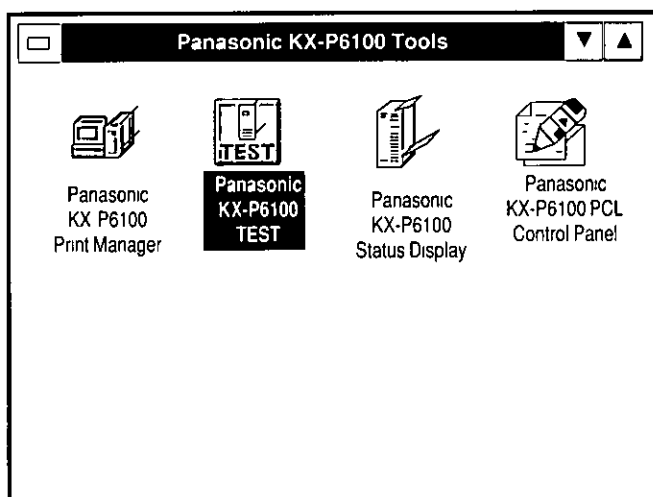

**2** Double click the **Panasonic KX-P6100 TEST** icon.

**3** Make sure the printer is ready and paper is loaded before clicking **OK**

**4** Click **Yes**

The Test program prints a configuration page that shows information about your PC and printer

**5** Click **Yes** to continue.

The printer will print two demo pages ( P 16)

**6** If you want to exit the Test program, click **OK**.

Clicking **Cancel** will return you to the Test program's main screen

### Note:

- It is recommended that you save a copy of the most recent configuration page with your manual as you may need it later

Demo page:



- Laser printing at up to 600p print quality
- PhotoEnhance: enhance print quality of a photo image
- Edge smoothing print function with EET™ (Edge Enhancement Technology)

### Real-Time Status Monitor



- Monitors the printer's status and operation through graphic display messages on your PC
- Show Me Function: this animated (trouble-shooting) feature will guide you through virtually any printer problem

### Environmentally Friendly



- Power Save: reduces power usage by slipping into the sleep mode if data isn't received
- TonerSaver™: reduces the cost of printing by as much as 50% for "draft mode"

### Windows™ & PCL™ Emulation

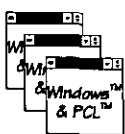

- New generation of Windows™ printing
- WYSIWYG printing (What You See is What You Get)
- HP LaserJet™ IIP emulation for DOS applications running through Windows™
- Microsoft® Windows™ 3.1 printer driver

### Ultra Compact Size



- One of the world's smallest laser printer footprint
- Ideal for users with limited space

### Silent Standby: Whisper Quiet Operation



- Less than 45dBA when printing
- Completely silent in standby mode (no fan--less noise and saves electricity)

### Variety of Print Formats

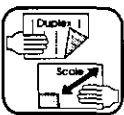

- Scale: enlarge or reduce the data output from 10 to 500%
- Manual Duplex: Print on both sides of your document
- 2up/4up: print up to 4 pages on a single page

© Copyright Kyushu Matsushita Electric Co., Ltd. 1994. All rights reserved.  
Trademarks are the property of their respective owners. Clipart images from Microsoft® PowerPoint and CoreDRAW! 4.0 were used in the preparation of this sample.

### EET test pattern:

This test pattern can be used to adjust the EET setting ( P. 29).

## Removing the KX-P6100 Software

If you need to remove the KX-P6100 software, run the KX-P6100 delete program. You need to run this program from Microsoft Windows.

**1** From the Program Manager menu, click "File".

**2** Click the "Run..." option.

The Run Program dialog box appears.

**3** At the prompt, type:  
C:\KXP6100\DELETE.EXE

If your KX-P6100 software is installed in a directory other than KXP6100, specify that directory name.

**4** Click **OK** or press **Enter**.

**5** Click **Yes** or press **Y**.



# Chapter 3 Print Modes

## Print Mode Selections

You can select either of the two print modes, GDI Mode or PCL Mode, according to your requirements. If you cannot determine which print mode is best suited for your printing applications under Windows, we recommend you always use GDI Mode first.

### GDI Mode has the following features

- faster printing—as much as four to five times faster for some files
- manual duplex printing ( P 19)
- top page (reverse printing) ( P 19)
- overlay function ( P 19)

### PCL Mode is effective in the following cases:

- when you want to print a file created with an MS-DOS application
- when you want to print a PCL format file
- when you want to print an ASCII formatted file
- print complex graphic files which Windows may not display well

## Printing From a Windows Application

Once you have selected your print mode (GDI or PCL emulation \*), just print from your Windows application as you would to any other printer.

\* Emulation means to operate like another printer.

## Printing From a DOS Application Within Windows

The KX-P6100 is a Windows printer, designed for use with Windows and does not work with MS-DOS. However, if the KX-P6100 is in PCL Mode, it can print a DOS application file as follows. Double click the MS-DOS icon in the Main window, start the DOS application and print a file.

## Changing the Print Mode

There are two methods given below to change the print mode, GDI Mode or PCL Mode.

### **A** Changing the print mode from an application:

Most of the popular Windows applications allow you to change GDI Mode / PCL Mode. For example, to change the mode in Microsoft Write, perform the following:

- 1** Select "Print Setup." under File Menu.  
Print Setup window will be displayed.
- 2** Select the desired print mode.  
To change to GDI Mode or PCL Mode, select "Panasonic KX-P6100 GDI on 6100 GDI" or "Panasonic KX-P6100 PCL on 6100 PCL."
- 3** Click **OK**.

## Print Modes (GDI Mode)

### B Changing the print mode by using the Control Panel in Windows:

- 1 Double click the *Main* icon in the Program Manager to display the Main window.
- 2 Double click the *Control Panel* icon in the Main window.
- 3 Double click the *Printers* icon in the Control Panel window.
- 4 Select the desired print mode.  
To change to GDI Mode or PCL Mode, select "Panasonic KX-P6100 GDI on 6100 GDI" or "Panasonic KX-P6100 PCL on 6100 PCL".
- 5 Click **Set As Default Printer**.  
The print mode you selected in step 4 appears in the Default Printer field.
- 6 Click **Close**.

## KX-P6100 GDI Mode

You can select the GDI Mode from an application or through the Control Panel's Printer window ( See above). The Panasonic KX-P6100 GDI window lets you select certain settings for your print job.

To display the Panasonic KX-P6100 GDI window, perform the following.

- 1 Double click the *Main* icon in the Program Manager.  
Main window will be displayed.
- 2 Double click the *Control Panel* icon.  
Control Panel window will be displayed.
- 3 Double click the *Printers* icon.  
Printers window will be displayed.
- 4 Select "Panasonic KX-P6100 GDI on 6100 GDI".
- 5 Click **Setup**.  
Panasonic KX-P6100 GDI window will be displayed.

The screenshot shows the Panasonic KX-P6100 GDI window with the following settings:

- Copies:** 1
- Print Quality:** 300 x 300
- Paper Size:** Letter 8½x11 in
- Paper Source:** Main Tray
- Orientation:** Portrait (selected)
- Top Page:** 1, 2, 3 (selected)
- Manual Duplexing:** Off (selected)
- Scale:** 100
- Buttons:** OK, Cancel, Overlay..., Image..., 2 Up/4 Up, Default, About, Help
- Checkboxes:** Use Print Manager, Print to File, Print Instruction (disabled)

Legend: : enable, : disable

## Copies:

Allows you to determine how many copies of the document will be printed.

## Print Quality:

Your printer provides only one print quality: 300 × 300 dpi (dots per inch).

## Orientation

Choose **Portrait** (vertical) or **Landscape** (horizontal).

## Paper Size

Allows you to select a different paper size.

## Paper Source

Your printer has only one paper source: Main tray.

## Use Print Manager

Putting an **X** in the box marked "Use Print Manager" turns the Print Manager on when using GDI Mode. The KX-P6100 Print Manager allows you to use:

- Top page (reverse printing)
- Manual Duplexing
- Overlay
- KX-P6100 Print Manager screen ( P. 26)

However, the print speed will be slower when the KX-P6100 Print Manager is activated.

## Top Page

The printer normally prints documents in page number order (i.e. page 1 first). Clicking on the **3, 2, 1** button in the Top Page box will instruct the printer to print your output in reverse.

## Manual Duplexing

You can print your file on both sides of the paper by selecting either **Book** or **Report**. When performing this feature, you can follow the instructions displayed on the screen.

## Overlay

The Overlay feature lets you overlay an image over any document printed in GDI Mode ( P. 20).

## Print to File

If you select **Print to File**, your output will go to a file instead of the printer.

The print file is stored in GDI format. See the KX-P6100 Print Manager ( P. 26) for information on how to print from a file using the Add button.

## Scale

Use Scale to reduce or enlarge your output on the printed page from 10% to 500%.

## Image

The Image feature lets you adjust the brightness and contrast of your output. Also see "Using Image" on page 23.

## 2 Up/4 Up

The printer lets you print 2 or 4 pages on a single sheet of paper. Also see "Using 2 Up/4 Up" on page 23.

## OK

Click **OK** to make your changes take effect and return to the previous screen.

## Cancel

Click **Cancel** to ignore any changes you have made and return to the previous screen.

## Default

Click **Default** to restore all settings to their default values.

## About

Click **About** to display the program version and copyright information.

## Help

Click **Help** for detailed information about the KX-P6100's Help system. Within the Help system, you can select Contents to see a list of topics related to the KX-P6100.

# Print Modes (GDI Mode)

## Using Overlay

You can use the Overlay feature to:

- Incorporate your letterhead on the first page of a business letter.
- Print your logo at the bottom of each page of a set of presentation slides.
- Overlays the word "Confidential" on every page of an important document.
- Print a special cover page or trailer page (see below) for each print job.

**1** Make sure that **Use Print Manager** is selected on the **Panasonic KX-P6100 GDI** window ( P. 18).

**3** Click **Overlay**.  
The Overlay Options screen appears.

**2** Make sure that **Book** and **Report** in the **Manual Duplexing** box are not selected ( P. 18).

Overlay Options

Print Cover Page: [ ]

Print Overlay: [ ]

None

All

From: [ ] To: [ ]

Print Trailer Page: [ ]

OK

Cancel

Browse...

: enable  
: disable

### Print Cover Page

Select this feature to print your image on a separate page before the rest of your document.

### Print Overlay

This feature will overlay your image over pages of your document. The effect is similar to printing your image on a transparency, then putting the transparency over your document.

- Select **All** to overlay the image on each page in the document.
- Select **From** to overlay the image on a range of pages within the document.
- Select **None** to disable the Overlay feature.

### Print Trailer Page

Select this feature to print your image on a separate page after the rest of your document.

### Browse

After selecting **Print Cover Page**, **Print Trailer Page**, or **Print Overlay**, clicking **Browse** will let you search for your GDI file in the file system.

## Overlaying and printing a document:

- Using an application such as Paintbrush, CorelDRAW or PageMaker, create and save a graphic file that you want to overlay on pages of a document.
- Verify the graphic by printing it out, and minimize the application.
- Change the printing mode to "Panasonic KX-P6100 GDI on 6100 GDI" ( P. 18).
- Click **Setup** in the Printers window. The Panasonic KX-P6100 GDI window will appear.

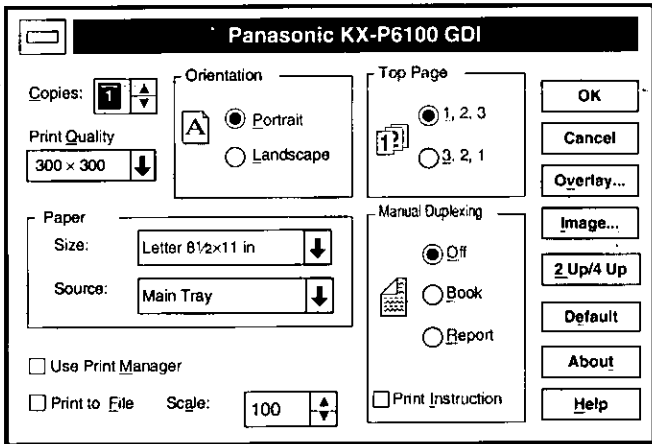

- Select "Print to File" by clicking on the check box at the left. An X mark appears in the check box.

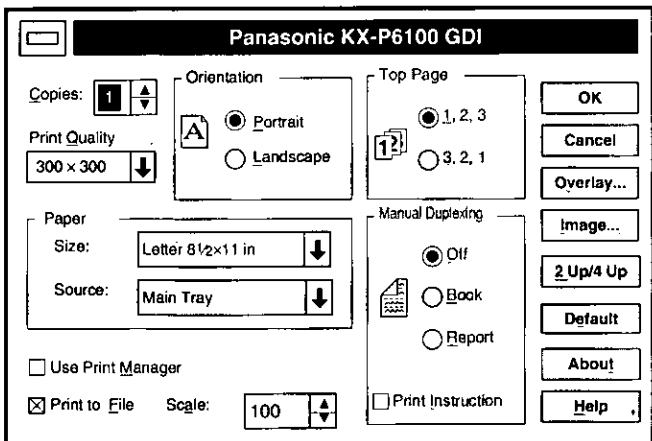

- Click **OK**. The Printers window will appear.
- Click **Close**.
- Double click the same application which you minimized in step 2 and perform the print operation. A screen asking you to enter the file name will appear.
- Enter a new file name or the same file name with the GDI extension (.GDI) and click **OK** to store the file as a GDI file.
  - The GDI file extension must be used to designate the difference between a GDI file and an application file. Otherwise, the application file will be overwritten by a GDI file.
- Minimize the application.
- Perform steps 3 and 4 above.
- Disable the "Print to File" feature by clicking off the check box at the left. The X mark will be cleared from the check box.

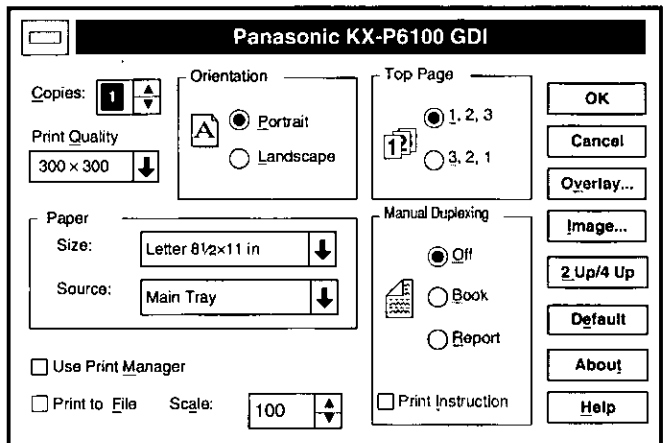

## Print Modes (GDI Mode)

- 13** Select "Use Print Manager" by clicking on the check box.  
An X mark appears in the check box.

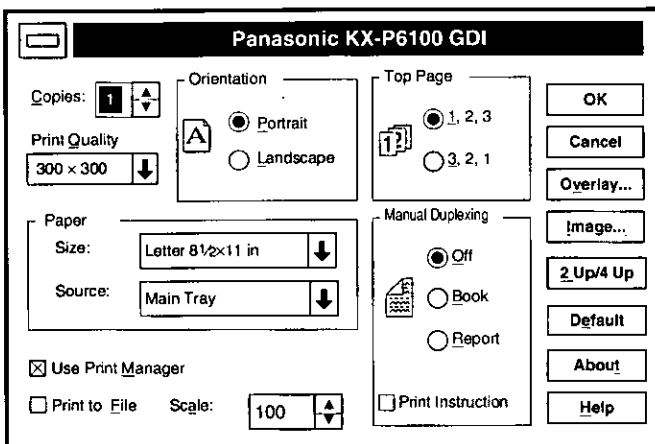

- 14** Click **Overlay**.  
The Overlay Options window will appear.

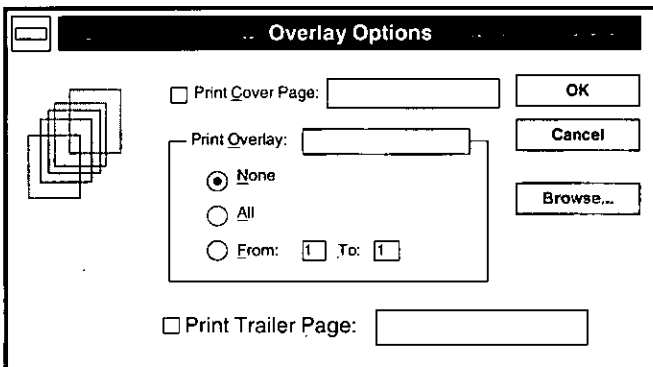

- 15** Click on the desired selection (s).  
For example, select Print Cover Page.

- 16** Click **Browse**.  
The Browse window will appear.

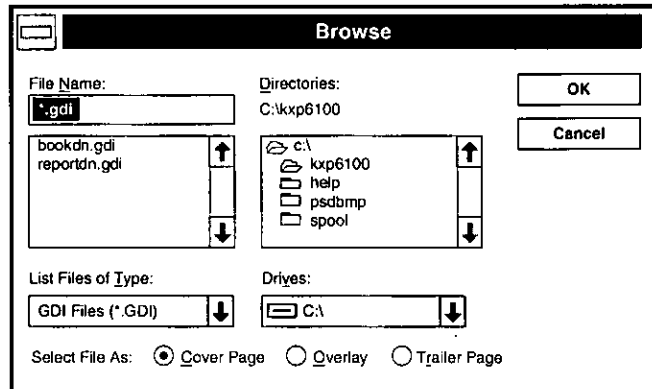

- 17** Double click on the directory in which you saved your graphic file (GDI file), then select the file and click **OK**.  
The selected file will appear in a box in the Overlay Options window.

- 18** Click **OK** in the Overlay Options window.

- 19** Click **OK** in the Panasonic KX-P6100 GDI window.

- 20** Click **Close** in the Printers window.

- 21** Print the desired document.  
The graphic will be overlaid on the pages of your document.

## Using Image

Click **Image** on the Panasonic KX-P6100 GDI window ( P 18)  
The Image Options screen appears

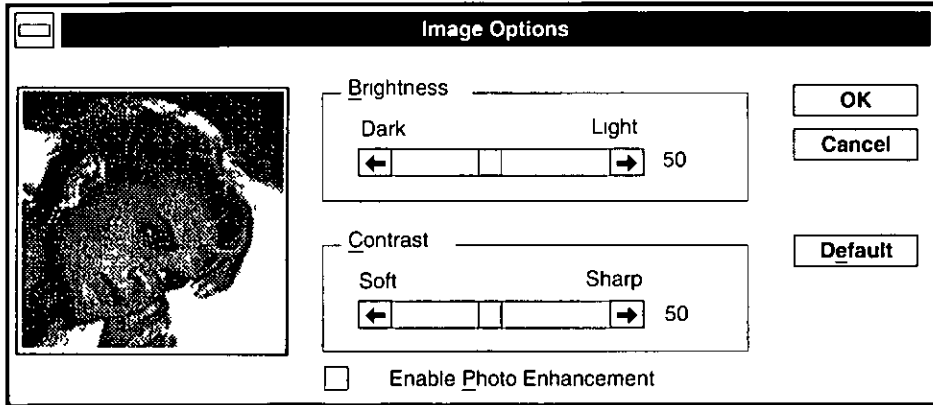

The Image Options screen lets you adjust the appearance of your output. These adjustments only apply to certain types of images and grayscales, not to text or black line drawings. Refer to page 29, TonrSavR, for information on lightening the appearance of text and some line art.

The figure at the left of the screen will change as you move the controls, giving you a rough idea of the effect of your adjustments.

### Brightness Control

Drag the **Brightness** knob or click on the **arrows** to vary the shades of gray, making the image output appear lighter or darker.

### Contrast Control

Drag the **Contrast** knob or click on the **arrows** to make the image output appear sharper or softer.

### Enable Photo Enhancement

Clicking on **Enable Photo Enhancement** will improve the quality of the image output.

## Using 2 Up/4 Up

Click **2 Up/4 Up** on the Panasonic KX-P6100 GDI window  
The 2 Up/4 Up printing screen appears

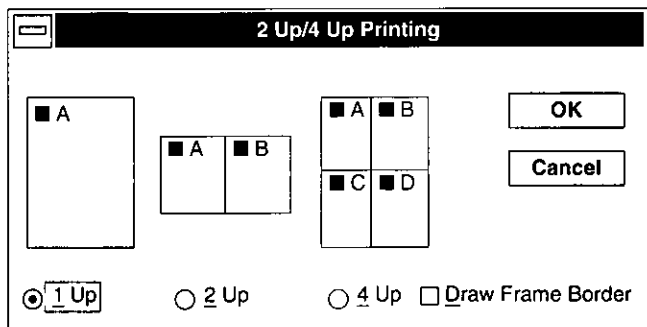

- **1 up** prints normally
- **2 up** prints two pages on one sheet of paper. In portrait mode, the pages display side by side as in a book.
- **4 up** prints four pages on one sheet of paper.

### Draw Frame Border

If you click on **Draw Frame Border**, the printer will draw a box around each page on the paper.

# Print Modes (PCL Mode)

## KX-P6100 PCL Mode

You can select PCL Mode from an application or through the Control Panel's Printer window ( P. 18).

### PCL Control Panel

The KX-P6100 lets you print from MS-DOS applications, but you must run the application from Windows or within the DOS box under Windows. Your printer also provides a PCL Control Panel similar to the conventional PCL printer's key panel for DOS PCL printing. This allows you to change printer settings for your DOS print jobs.

To display the Panasonic KX-P6100 PCL Control Panel, perform the following.

- 1 From the Program Manager, double click the *Panasonic KX-P6100 Tools* icon.**  
The Panasonic KX-P6100 Tools window will be displayed.
- 2 Double click the *Panasonic KX-P6100 PCL Control Panel* icon.**  
The Panasonic KX-P6100 PCL Control Panel window will be displayed.

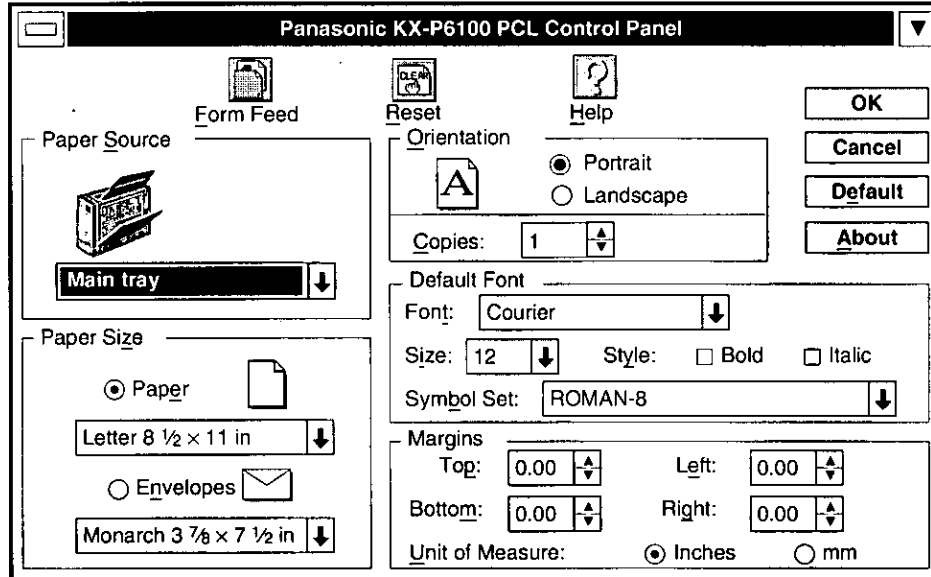



## Form Feed



Some PCL files do not include a form feed (a command to eject a page) at the end of the file, so the last page will not be printed. If this happens, you must click the **Form Feed** button to print it out.

## Reset



Clicking the **Reset** button clears all data from the printer's memory, including forms, macros, and unprinted page images.

Note that the **Reset** button does not change the printer settings (orientation, paper size, number of copies, etc.) to the original default values. Click **Default** to restore defaults.

## Help



Click the **Help** button for detailed information about the KX-P6100's Help System.

## Paper Source

Your printer has only one paper source: Main tray.

## Paper Size

To select paper/envelope from within the Paper Size box, first click on the paper/envelope icon. Then select the paper/envelope size that you wish to use.

## Orientation

Choose **Portrait** (vertical) or **Landscape** (horizontal).

## Copies

Allows you to determine how many copies of the document will be printed.

## Default Font

Default font lets you select the default typeface, size, and style for print jobs that are output from MS-DOS applications run under Windows and for Windows PCL print jobs. Both MS-DOS and Windows applications can override the default font selection.

- Please note that you do not have access to Windows TrueType fonts for MS-DOS print jobs.

## Margins

The Margins settings let you define the top, bottom, left, and right margins for PCL print jobs. Please note that DOS and Windows applications may override these settings.

## OK

Click **OK** for your changes to take effect. When you exit, the PCL Control Panel will load the PCL compatible interpreter into your PC's memory. This will save time when you later print from MS-DOS applications under Windows.

However, you can close the PCL compatible interpreter and recover the memory, if you wish. Click the **KX-P6100 PCL Control Panel** icon, then click **Close**.

## Cancel

Clicking **Cancel** will lose any changes you have made to the PCL printer settings, and will exit the PCL Control Panel without loading the PCL compatible interpreter.

## Default

Click **Default** to restore all printer settings on the screen to their default values.

## About

Click **About** to display the program version and copyright information.

# Chapter 4 *KX-P6100 Print Manager*

The Panasonic KX-P6100 Print Manager controls all output to your KX-P6100 printer. You can list all files that are waiting to be printed or change their order. You can display how much of the current print job has been processed. You can control how high the priority for printing will be compared to other applications running at the same time.

To display the Panasonic KX-P6100 Print Manager window, perform the following.

- 1 From the Program Manager, double click the *Panasonic KX-P6100 Tools* icon.**  
The Panasonic KX-P6100 Tools window will be displayed.

- 2 Double click the *Panasonic KX-P6100 Print Manager* icon.**  
The Panasonic KX-P6100 Print Manager window will be displayed.

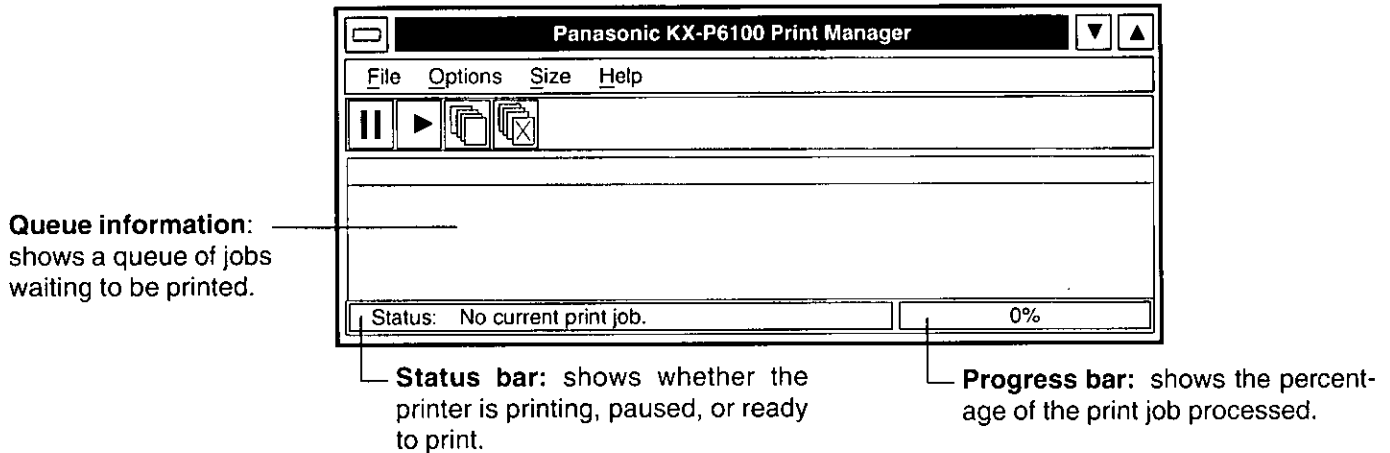

## Queue Information

Each entry in the queue includes the following information.

### **JOB NAME**

The software application and file that created the print job.

### **FORMAT**

GDI or PCL format.

### **SIZE**

The total number of bytes occupied by the print job.

### **TIME**

Time the print job was created.

The time can be in either 12- or 24-hour format, depending on what you select on the Options Menu.

## Changing the Order of Print Jobs:

- 1 Move the mouse to the entry you want to change.**
- 2 Press down on the left button of your mouse. Do not lift your finger.**  
The entry will turn blue to indicate that it has been selected.
- 3 Without lifting your finger, drag the print job (drag the mouse) to the desired new location in the queue.**
- 4 Release your finger from the mouse button.**  
The print job is now in its new location, and the other print jobs will move up or down in the queue as necessary.

## File Menu

From the Panasonic KX-P6100 Print Manager window, click "File" to display the File Menu.

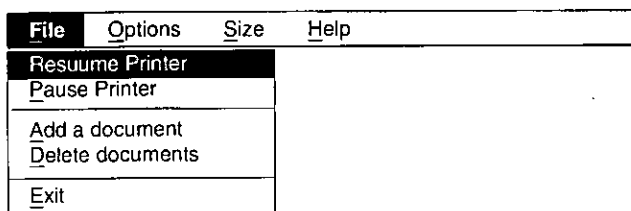

### Resume Printer

Resume Printer lets you resume printing a job that has been paused.

### Pause Printer

Pause Printer lets you pause the current job.

### Add a document

Add a document lets you select a print job file in PCL or GDI format and add it to the end of the print queue. Be sure to select the correct file format (GDI, PCL) for the file you wish to print. You can download macros or soft fonts using this feature.

### Delete documents

Delete documents lets you cancel a currently printing job that has been paused.

### Exit

Exit lets you exit the KX-P6100 Print Manager program.

## Options Menu

From the Panasonic KX-P6100 Print Manager window, click "Options" to display the Options Menu.

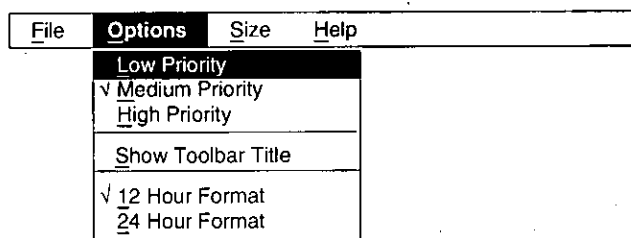

### Priority (Low/Medium/High)

Windows lets you run several applications at the same time. The KX-P6100's priority settings let you control the priority of the printing activity relative to other applications running at the same time.

The Options Menu lets you select high, medium, or low priority processing for printing. Printing at high priority produces output faster, but your other applications may slow down. On the other hand, printing at lower priority lets your other applications run faster, but also means your document will take longer.

### Show Toolbar Title

This option lets you display or remove the titles to the KX-P6100 Print Manager icons that represent Pause, Resume, Add, and Delete.

### 12/24 Hour Format

You can select the format for which the time is displayed: 12- or 24-hour. (01:30 PM is an example of 12-hour format. The same time appears as 13:30 in 24-hour format.)

## Size Menu

From the Panasonic KX-P6100 Print Manager window, click "Size" to display the Size Menu.

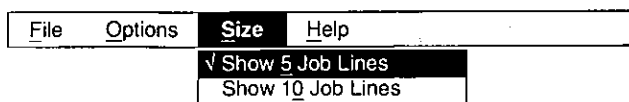

### Show 5/10 Job Lines

Show 5/10 Job Lines lets you determine the number of print jobs you want the KX-P6100 Print Manager to display. You can show a maximum of up to 5 or 10 print jobs in the queue.

# Chapter 5 KX-P6100 Status Display

The Panasonic KX-P6100 Status Display program has two primary functions:

- To let you control certain features of your printer, such as Power Saving Mode.
- To alert you in case of a problem with your printer, for example, if the paper jams ( P. 30).

To display the Panasonic KX-P6100 Status Display window, perform the following.

- 1 From the Program Manager, double click the **Panasonic KX-P6100 Tools** icon.  
The Panasonic KX-P6100 Tools window will appear.

- 2 Double click the **Panasonic KX-P6100 Status Display** icon.  
The Panasonic KX-P6100 Status Display window will appear.

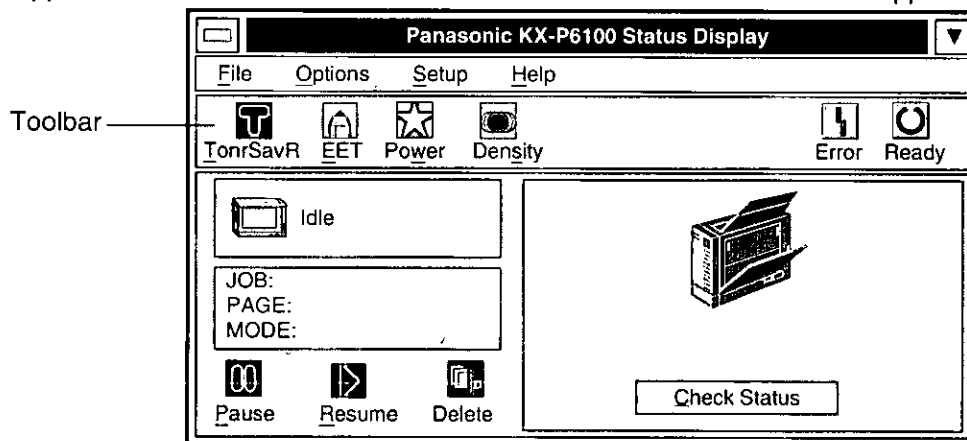

## File Menu

This menu allows you to exit the Panasonic KX-P6100 Status Display Program.

## Options Menu

The selections in this menu control the Panasonic KX-P6100 Status Display software.

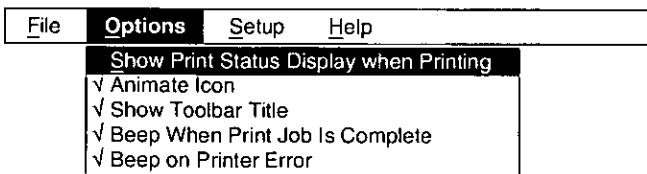

√: enable

### Show Print Status Display When Printing

If you select this option, the Panasonic KX-P6100 Status Display window will appear when you print a document. Otherwise, the Panasonic KX-P6100 Status Display window will only display when an error occurs.

### Animate Icon

When the printer icon is animated, it will appear to be printing whenever an actual print job is in process.

### Show Toolbar Title

Select this option if you want to see titles for the toolbar icons: toner saver, EET (Edge Enhancement Technology) power saving, and density.

### Beep When Print Job Is Complete

This option tells the printer to beep whenever it finishes printing a document. If you turn this selection off, the KX-P6100 will make no sound when printing has finished.

### Beep On Printer Error

This option instructs the printer to beep whenever it encounters a printer problem, such as when the printer runs out of paper. If you turn this selection off, the printer will display an error message, but it will not beep, if a problem occurs.

## Setup Menu

This menu displays the Change Printer Settings screen

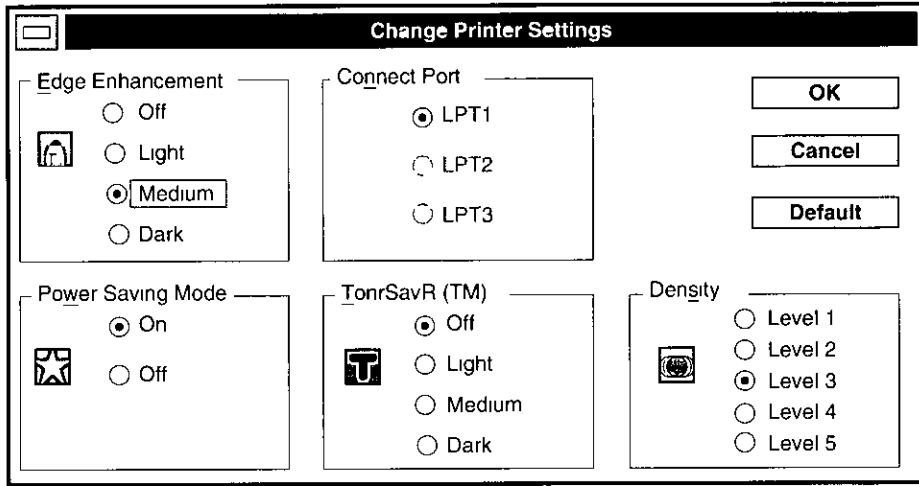

### Edge Enhancement Technology (EET)

With Edge Enhancement turned on, the KX-P6100 will smooth the jagged edges of text and line art, giving the output a very high quality appearance. There are three settings: **Light**, **Medium**, and **Dark**. The factory default setting is Medium. If the EET setting is too dark, the edges appear to bulge.

The demo page of the test print (  P 16) has an Edge Enhancement test block. As a general guideline, select the EET setting so as to make this block look like a uniform gray block with no vertical lines in it as shown in Figure 2.

If there are white vertical lines in the test print (Figure 1), set the EET to a darker setting. If there are dark vertical lines in the test print (Figure 3), set the EET to a lighter setting.

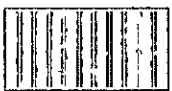

Figure 1



Figure 2



Figure 3

### Power Saving Mode

With Power Saving Mode turned on, you can save energy by instructing your printer to enter a low power consumption mode if you do not use it for 15 minutes.

**For USA:** To conserve energy and reduce operating cost, the printer is equipped with a programmable power save feature. The printer is factory set with the power save feature turned on and programmed to 15 minutes to comply with EPA's Energy Star requirements.

### Connect Port

The Connect Port option lets you select a different parallel port for your printer. Depending on what your PC has available, you can choose LPT1, LPT2, or LPT3.

### TonrSavR Mode

With TonrSavR turned on, the KX-P6100 will reduce the amount of toner used to print the image. Black areas and text are replaced by a light gray shading.

- **Light.** Text and objects on the page have a black outline along their left edge.
- **Medium.** Text and graphics have a black outline along their left and right edges.
- **Dark:** Text and graphics have a black outline along all edges. This setting is recommended over Light and Medium if you expect to fax or photocopy the document.
- **Off.** This is the default setting and is recommended for the highest quality. Output appears normal.

### Density

The Density option lets you choose from level 1 to level 5. To make print lighter, choose a lower level button. To make print darker, choose a higher level button.

#### Note

- The EET, Power Saving Mode, TonrSavR Mode and Density features also appear on the Panasonic KX-P6100 Status Display Toolbar.

# KX-P6100 Status Display

## Printer Problem Status Messages

The Panasonic KX-P6100 Status Display program will alert the user to any errors. It displays a warning or error message, identifies the problem area on the printer, and provides information regarding corrective action.

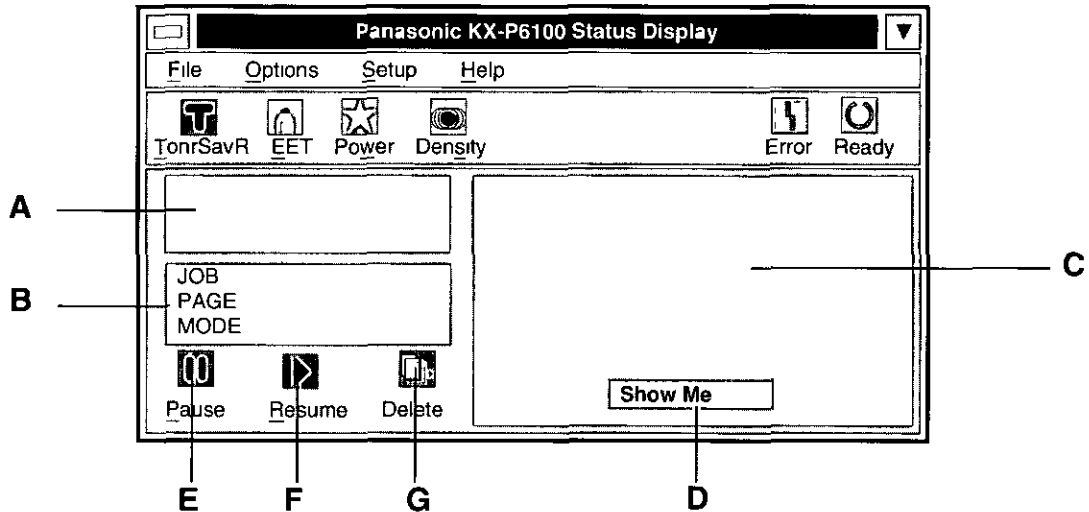

- A.** This box shows an error or status message and corresponding icon
- B.** This box lists the name of the application, file name, page number for the job currently being printed, and the mode your printer is in
- C.** This box displays a picture of your printer. If a problem has occurred, an arrow identifies where the printer is affected. The display also provides corrective action for each error or status message
- D.** If you need additional help in resolving the problem, click the **Show Me** button. This animated help feature will walk you through the steps required to get your printer running once again
- E.** The **Pause** button lets you pause printing. For example, you can pause in order to cancel the print job from the application
- F.** The **Resume** button lets you continue printing after you have paused printing, or after recovering from an error situation
- G.** The **Delete** button lets you delete the job currently printing. You must pause the job before you can delete it, unless the printer itself is paused because of an error

If you are not currently printing data, the **Show Me** button appears as **Check Status**. Click the **Check Status** button to display the current status of the printer.

# Chapter 6 Care and Maintenance

## Cleaning the Printer

Periodic cleaning of the printer is recommended. The frequency of cleaning is dependent upon the environment. You should clean the printer:

- at least once a month.
- when you install a new Process Unit.
- when print quality has deteriorated.

### Outside of the Printer

- 1 Turn the power OFF.
- 2 Clean the cover with a soft cloth.  
Use any mild commercial cleaner.

#### Caution:

- Do not use benzine, thinner, aerosol cleaners, or any abrasive powder to clean the cabinet.

### Inside of the Printer

- 1 Turn the power OFF.  
Before cleaning the inside of the printer, allow the fuser to cool (about 5 minutes).
- 2 Open the left cover.

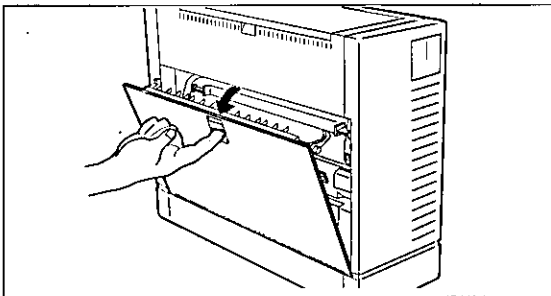

- 3 Clean the following areas with a dry cloth or a cotton swab.

With a dry cloth

- Pinch roller
- Feed roller
- Transfer roller
- Paper chute (Paper dust)

With a cotton swab

- Carefully wipe the tungsten wire by sliding a cotton swab from end to end 4 to 5 times.

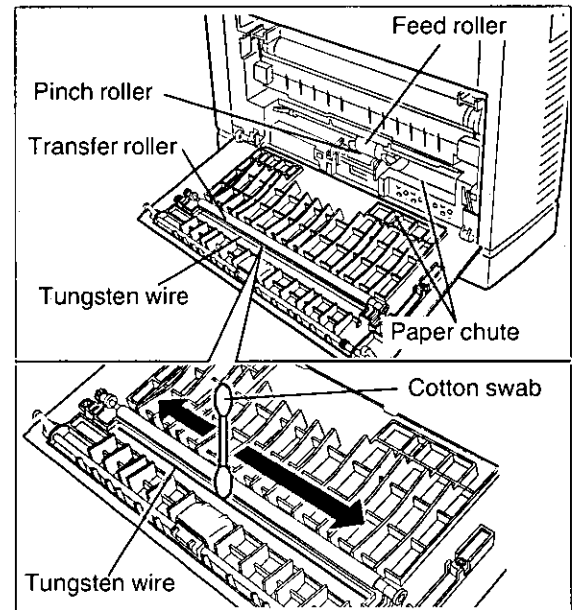

#### Cautions:

- The printer must be turned OFF prior to cleaning.
- Do not expose the process unit to light for more than 5 minutes.
- Do not touch the green drum surface.

- 4 Close the left cover.

# Care and Maintenance

## Troubleshooting

Many problems associated with the printer can be traced to improper setup or cabling. The following table will assist you in identifying and correcting some of the more common problems.

Trouble	Possible Cause	Corrective Action
Printer not printing and neither indicator is lit/blinking	No AC power	Check power cord.
Power on but printer not printing data	Interface cable not connected	Check interface cable.
	Improper cable is connected	Replace the cable with the one whose all pins have been connected.
Paper jams occur continually	The paper size selected through the GDI Mode, PCL Mode or software application is different from the installed paper size	Select the correct paper size through the GDI Mode ( P. 18), PCL Mode ( P. 24), or application.
Stains on paper	Dirty paper path	Clean paper path ( P. 31).
Vertical line on paper	Dirty paper path	Clean paper path ( P. 31).
	Dirty tungsten wire	Clean tungsten wire ( P. 31).
	Scratch on drum	Replace process unit.
	Scratch on fuser roller	Replace fuser. The printer requires service by an Authorized Panasonic Service Center.
Very faint print	Toner may be empty	Shake the Process Unit or refill the toner in the Process Unit ( P. 35).
	Print density not adjusted	Select the proper print density ( P. 29).
	Abnormal transfer corona current	Replace the transfer corona. The printer requires service by an Authorized Panasonic Service Center.
Printout is raggedy	Screen fonts may be selected	Replace the screen fonts with TrueType fonts. To show only TrueType fonts in applications, follow the procedure below. <ol style="list-style-type: none"> <li>1. Double click the <b>Main</b> icon in the Program Manager.</li> <li>2. Double click the <b>Control Panel</b> icon.</li> <li>3. Double click the <b>Fonts</b> icon.</li> <li>4. Click <b>TrueType</b>.</li> <li>5. Select "<b>Show Only TrueType Fonts in Applications</b>", and click <b>OK</b> to exit the TrueType dialog box.</li> </ol>
Paper jam has occurred	Follow the instructions displayed on the screen. If you need additional help, click the <b>Show Me</b> button for animated help. If stains appear on the back of the printed paper after a paper jam is cleared, it is recommended that you run several test prints ( P. 15 "Testing the Printer").	
Ejected paper is caught between the paper support and the output tray	There is a space between the output tray and the paper support	Slide the paper support down and then extend it again to remove the space ( Step 1 on page 12).
DOS application file cannot be printed	Operation in the Background is not effective	Disable the Exclusive in the Execution field on the PIF Editor or start the DOS application from the MS-DOS prompt of the Windows.



## Cautions:

- The fuser is hot, do not touch it.
- Do not expose the process unit to light for more than 5 minutes.
- Do not touch the green drum surface.
- If the jammed paper has toner on it, do not pull it out through the paper feed slot.
- Be sure that no paper fragments remain in the printer.

## Repacking Instructions

It is highly recommended that you keep the original carton and ALL packing materials. Should you need to transport or ship your printer, please follow these instructions.

### Please Note:

- Should you need to send your printer to a Service Center, consult your dealer first. If there is nothing wrong with the Process Unit, send the printer without the Process Unit to prevent the toner from leaking or the drum from getting damaged.
- Please use the original carton and all of the original packing material.
- Improper repacking of the printer may result in a service charge to repair the unit or a cleaning charge to remove spilled toner.
- Since the printer uses dry toner, extreme care must be taken when handling. The printer should be handled in the upright (vertical) position.

### Material Required:

- Original Printer Carton & Packing Materials
- Original Process Unit Carton & Packing Materials
- Newspaper or drop cloth
- Shipping Tape & Scissors

**1** Disconnect the AC line cord and the printer/computer cable.

**2** Close the paper support and the output tray (top cover).

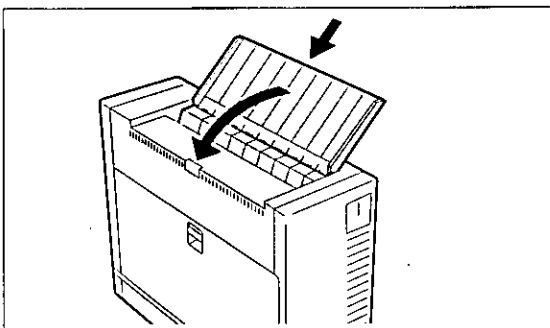

**3** Open the left cover.

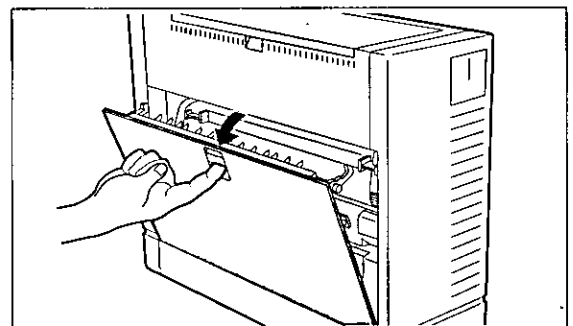

## Care and Maintenance

- 4** Remove the Process Unit by holding the green labeled tabs and pulling it toward you.

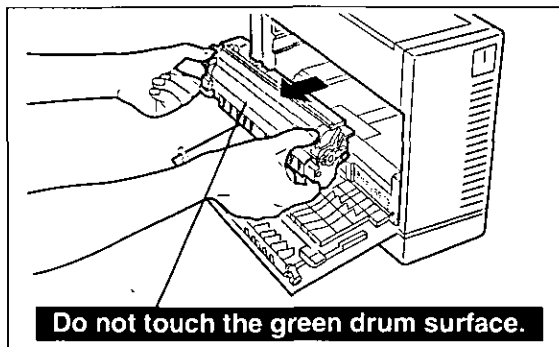

- 5** **1** Place the protective sheet on the green drum.  
**2** Put the Process Unit into the plastic bag and close the bag.

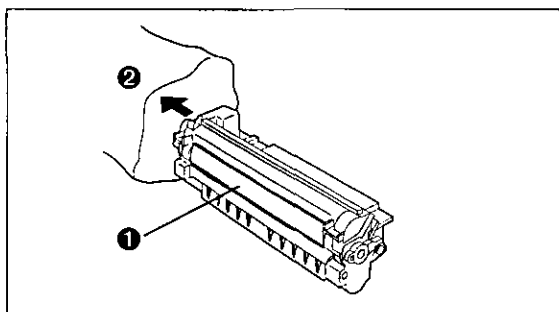

- 6** Replace the Process Unit by holding the green labeled tabs and pushing it into the printer.

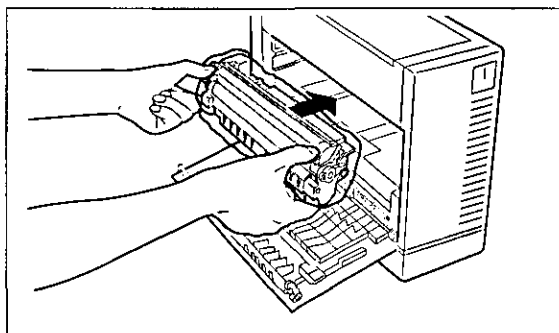

- 7** Close the left cover.

- 8** Repack the printer.

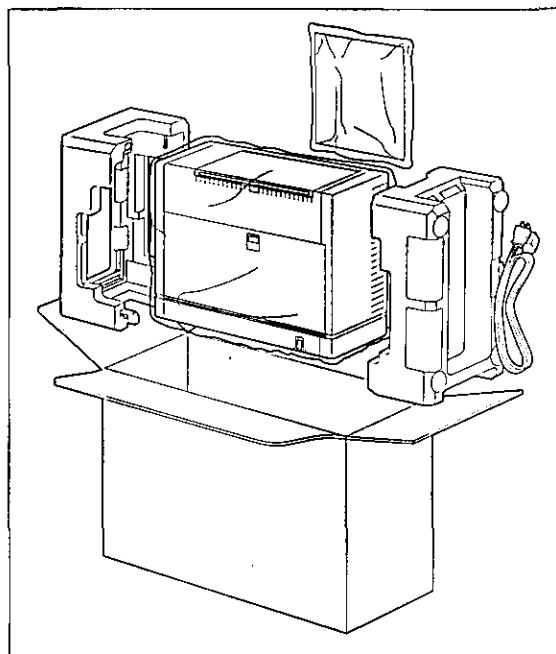

# Appendix

## Supplies

Please contact your local Panasonic dealer for availability  
The following supplies have their own Instructions/Installation Manuals

Supplies	
KX-P456	Toner Cartridge — 2,000 page life
KX-PEP2	Process Unit — 15,000 page life

### Note:

- The page life above is based upon printing 4% image area with repetitive printing of 10 pages

## Refilling the Toner in the Process Unit

When the print is faint, the toner may be almost empty. However, the printer may print some pages if you shake the Process Unit a few times. Fill the toner in the Process Unit using the toner cartridge KX-P456. The instructions below are the outline procedure. For detailed instructions, please refer to the KX-P456 instructions manual.

### Extending the toner life:

Shake the Process Unit

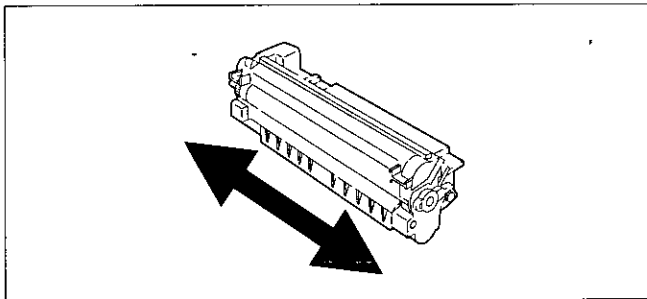

### Refilling the toner:

- 1** Remove the Process Unit from the printer (see Steps 1-5 on P. 33).

- 2** Open the toner cover of the Process Unit.

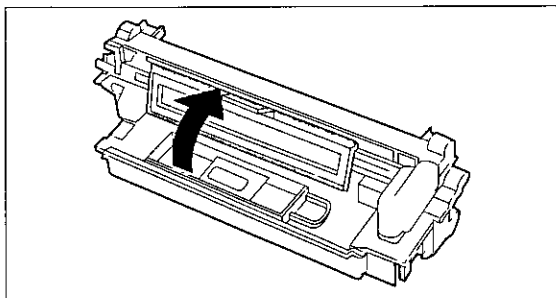

- 3** Place the toner cartridge on the Process Unit and slide the toner cartridge to the left until it stops.

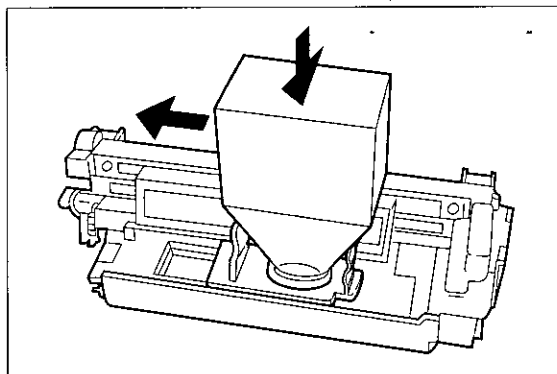

- 4** Shake the Process Unit and tap the toner cartridge to let the toner fall into the Process Unit.

- 5** Remove the toner cartridge by sliding it to the right and lifting.

## Printer Specifications

<b>Printing Method:</b>
Semiconductor Laser
<b>Print Speed:</b>
6 pages per minute (ppm) maximum (Letter size paper, text mode, 5% image area, all originals)
<b>Resolution:</b>
300 dots per inch (dpi)
<b>Paper Feed:</b>
1 Multi-purpose tray up to 100 sheets [75 g/m <sup>2</sup> (20 lbs.)]
<b>Paper Output:</b>
Up to 50 sheets
<b>Power Source:</b>
Refer to the nameplate on the rear of the unit
<b>Software Emulation *1 :</b>
HP LaserJet Series IIP
<b>Fonts:</b>
<u>GDI mode</u> TrueType fonts in Windows
<u>PCL mode</u> Courier 10 point, 12 pitch: Regular, Bold, and Italic Courier 12 point, 10 pitch: Regular, Bold, and Italic Line Printer 8.5 point, 16.66 pitch: Regular
<b>RAM Buffer:</b>
256 KB
<b>Interface:</b>
Bidirectional parallel
<b>Operating Environment:</b>
10 to 32.5°C {50 to 90.5°F} 20 to 80% RH

<b>Storage Environment:</b>
0 to 35°C {32 to 95°F} 10 to 80% RH
<b>Dimensions:</b>
132 (W) × 378 (D) × 287 (H) mm {5.2" × 14.9" × 11.3"}
<b>Mass {Weight}:</b>
Approx. 6.5 kg {14.4 lbs.}
<b>Consumables/Life:</b>
Starter toner *2; 1,000 pages average (4% image area with repetitive printing of 10 pages) Toner cartridge; 2,000 pages average (4% image area with repetitive printing of 10 pages) Process unit; 15,000 pages average (4% image area with repetitive printing of 10 pages)
4% image area means that the black area within the printing area is 4%. Printing 8% image area continuously will reduce the life of the toner and of the Process Unit to about half as compare to printing 4% image area. The "TonrSavR Mode" allows you to save the toner and to maintain the life of the Process Unit. ( P. 29)
<b>Power Consumption:</b>
480 W TYPICAL (Printing with Fuser on) 9 W TYPICAL (Power Saving Mode)
<b>Noise Level:</b>
Printing: 45 dBA Standby: 0 dBA
<b>CPU:</b>
Intel N80C31BH-1 or N80C51BH-1 (13.309 MHz)
<b>Power Saving Mode:</b>
To conserve energy and reduce operating cost, this printer is provided with a power save feature. If the printer has not received data for 15 minutes, the printer will automatically enter into a power saving mode.

\*1 Emulation means to operate like another printer.

\*2 This toner is installed in the Process Unit at the factory before shipment of the printer.

## Paper Specifications

This printer is designed to work well with most types of paper. However, differences in paper may have significant effects on the quality of the print or the reliability of paper handling. It is strongly recommended that you always test paper before purchasing it to make sure it provides desirable performance. The following guidelines will be helpful.

### Paper Specifications

<b>Basic Weight:</b>
60 to 135 g/m <sup>2</sup> (16 to 36 lbs.)
<b>Thickness:</b>
3.7 to 7.5 mils (1 mil=1/1000")
<b>Moisture Content:</b>
4% to 6%
<b>Smoothness:</b>
100 to 300 Sheffield
<b>Acid Content:</b>
5.5 PH minimum
<b>Fusing Compatibility:</b>
Must not scorch, melt, offset material, or release hazardous emissions when heated to 200°C (392°F) for 0.1 second

<b>Cutting Dimensions:</b>
±0.0313 inch of nominal, corners 90°±4°
<b>Grain:</b>
Long grain
<b>Cut Edge Conditions:</b>
Cut with sharp blades, no paper dust
<b>Ash Content:</b>
Not to exceed 10%
<b>Curl:</b>
No allowable curl toward the side to be printed
<b>Packing:</b>
Poly laminated moisture proof ream wrap

**Note:**

- Please store your paper according to the recommendations of the manufacturer.

### Paper and Envelope Sizes

The following paper and envelope sizes are supported by the KX-P6100.

Medium	Name	Dimension
Paper	Letter	8.5" × 11" (216 × 279 mm)
	Legal	8.5" × 14" (216 × 356 mm)
	A4	8.27" × 11.7" (210 × 297 mm)
	Executive	7.25" × 10.5" (184.1 × 266.7 mm)
	B5	7.17" × 10.12" (182 × 257 mm)
	A5	5.83" × 8.27" (148 × 210 mm)
Envelope	Business #10	4.13" × 9.5" (104.9 × 241.3 mm)
	Monarch	3.88" × 7.5" (98.5 × 190.5 mm)
	International DL	4.33" × 8.66" (110 × 220 mm)
	International C5	6.4" × 9.02" (162 × 229 mm)

# Appendix

## Types of Paper to Avoid

- Extremely smooth or shiny paper or paper that is highly textured
- Coated papers
- Letterhead imprinted with low temperature or thermography. These materials may transfer onto the fusing roller and cause damage. Any pre-printed paper should use inks compatible with 200°C (392°F) for 0.1 second.
- Damaged or wrinkled paper, or paper with irregularities such as tabs, staples, etc.
- Multipart forms or carbonless paper
- Paper with a cotton and/or fiber content over 20%

## Two-Sided Printing

Two-sided printing is possible. However, you should not expect the same print quality and reliability that you get with one-sided printing. We strongly recommend that you follow the guidelines below.

- Use 75 to 90 g/m<sup>2</sup> (20 to 24 lbs.) paper. [Do not use 60 g/m<sup>2</sup> (16 lbs.) paper.]
- Do not load more than 50 sheets in the paper tray.
- Before loading paper in the tray, adjust it so that the edges are even.

## Printing OHP Transparencies and Labels

You may also print on labels and transparencies that are made for printer. Panasonic has tested and found that the following work satisfactorily.

OHP transparencies	3M154, 3M688, 3M688C, SCOTCH8803, 3M/SCOTCH-CG3300, 3M PP2500
Labels	AVERY 5351, AVERY XS6016 AVERY ACL01, ACL08, ACL16, ACL24, ACL33 Avery Graphic LG703724, LG704221, LG1053716, LG1054214 Avery Copier Labels (70 × 36 mm) Avery White (105 × 37 mm) 16 labels per sheet COPY TACK C-16, C-24 ESSELTE DATALINE, ESSELTE KOPIETIKETTER 15914, 15917, 15920, 15922 FASTONALL COPY-LINE 18-030, 18-033, 18-034, 18-035, 18-036, 18-037 HERMA Copy-print 4455, 4464

### Note:

- With any label stock, the labels must completely cover the backing material. (  figure below)

YES

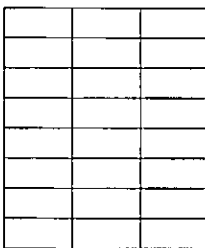

Labels cover the entire backing material

NO

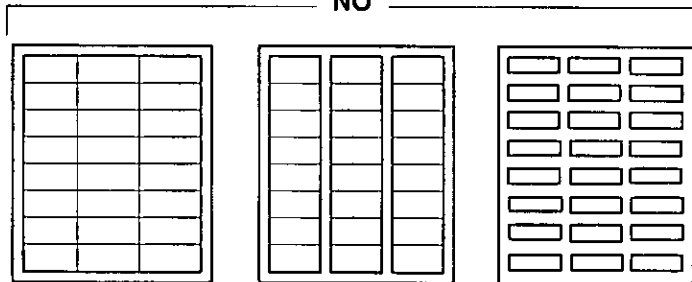

The backing material is exposed.

## Envelope Specifications

It is recommended that you purchase only high quality envelopes with diagonal seams, as shown in the diagram below:

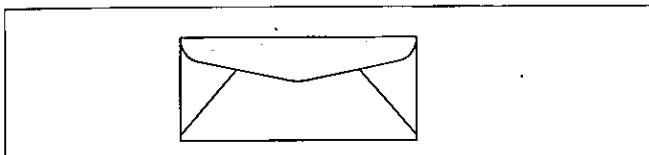

High quality envelopes have the following characteristics:

- A thin, sharply creased leading edge
- Paper weight or 90 g/m<sup>2</sup> (24 lbs.)
- Flat, free of curls, wrinkles, nicks, etc.

It is not recommended that you use envelopes with any of the following characteristics (using these may result in paper jams):

- Irregularly shaped envelopes
- Envelopes with curls, wrinkles, nicks, twists, dog-ears or other damage
- Envelopes with side seam construction
- Highly textured envelopes, or with extremely shiny surfaces
- Envelopes that seal by removing a peel-off strip
- Envelopes with more than one flap to be sealed
- Self-adhesive envelopes
- Envelopes that are baggy or not sharply creased
- Embossed envelopes
- Envelopes that have previously been printed on

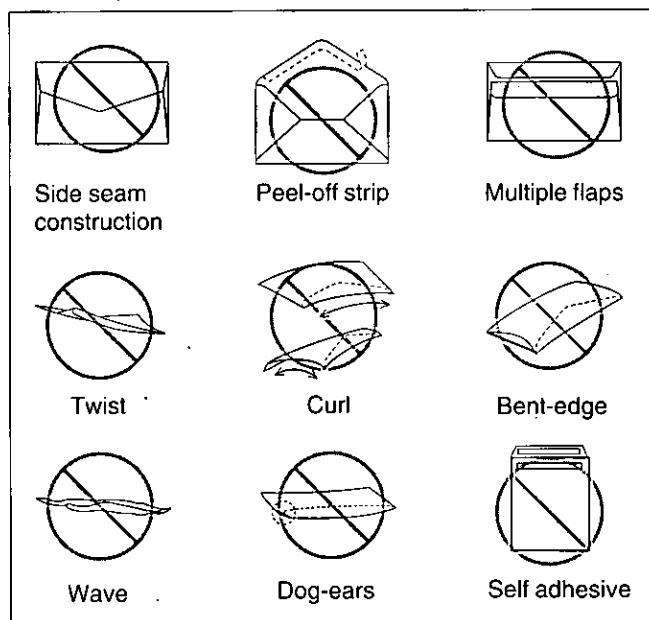

Do not attempt to print on any of the following types of envelopes. These may cause damage to your printer.

- Envelopes with clasps, snaps or tie strings (see Figure 1)
- Envelopes with transparent windows (see Figure 2)
- Envelopes that will melt, discolor, scorch offset or release hazardous emissions when exposed to 200°C (392°F) for 0.1 second
- Envelopes that use encapsulated types of adhesive that do not require moistening but rely on pressure to seal them

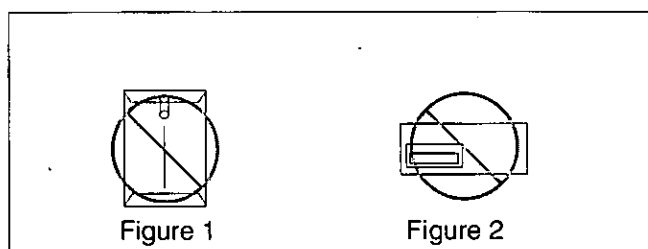

Always test a sample of the envelopes you are thinking of buying. Confirm that the envelope performs acceptably.

### For best printing results

- Avoid printing in high humidity i.e., above 70%. High humidity may cause the envelope to curl and pick up excess toner. High humidity may also cause the envelope to seal.
- Avoid printing below 10°C (50°F) with less than 30% relative humidity. Low temperature with low humidity may cause light printing.

Envelope storage is very important. Store them away from moisture and humid air, where they can lay flat and their edges won't be bent or damaged. The humidity should not exceed 70% RH.

# Appendix

## Interface Specifications

### Bidirectional Parallel Interface

The bidirectional parallel interface is based on the centronics standard.

If your software application supports the bidirectional parallel interface, it is possible to communicate between the computer and the printer at best speed by installing the enclosed software disks.

**Specifications:**

connector type	57-30360 (AMPHENOL) or equivalent
cable	use a shielded cable 2 meters (6.6 feet) or less in length

**Pin configuration**

Signal pin	Return side pin	Signal
1	19	nStrobe
2	20	Data 1
3	21	Data 2
4	22	Data 3
5	23	Data 4
6	24	Data 5
7	25	Data 6
8	26	Data 7
9	27	Data 8
10	28	nAck
11	29	Busy
12		PError

Signal pin	Return side pin	Signal
13		Select
14		nAutoFd
15		
16		SG
17		FG
18		+5V
31	30	ninit
32		nFault
33		SG
34		
35		
36		nSelectin

**Parallel Interface connector (printer side)**

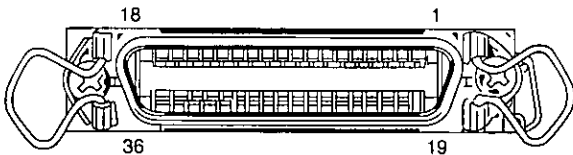

- Notes:**
- "Return" denotes the return side wire of a twisted pair cable and is connected to signal ground.
  - Be sure to use only the shielded cable whose all pins have been connected. If any of the pins are not connected, the printer will not operate properly.



# Index

## B

Bidirectional parallel interface . . . . . 6, 36, 40

## C

Carton enclosures . . . . . 8  
Change Printer Settings screen . . . . . 29  
  Connect Port . . . . . 29  
  Density . . . . . 29  
  Edge Enhancement Technology (EET) . . . . . 29  
  Power Saving Mode . . . . . 29  
  TonrSavR Mode . . . . . 29  
Check Status . . . . . 28, 30  
Cleaning printer . . . . . 31  
  inside . . . . . 31  
  outside . . . . . 31  
Copies . . . . . 19, 25

## D

Default . . . . . 19, 25  
Default font . . . . . 25  
Density . . . . . 29  
Duplexing . . . . . 18, 19

## E

Edge Enhancement Technology (EET) . . . . . 29  
Emulation . . . . . 17, 36  
Envelopes . . . . . 12, 13  
  loading . . . . . 13  
  sizes . . . . . 37  
Error message . . . . . 30

## F

Feed roller . . . . . 31  
Fonts . . . . . 36  
Form Feed . . . . . 25  
Frame ground terminal . . . . . 11  
Frame ground wire . . . . . 11

## G

GDI Mode . . . . . 18  
GDI window . . . . . 18  
  Copies . . . . . 18, 19  
  Image . . . . . 18, 19  
  Manual Duplexing . . . . . 18, 19  
    Book . . . . . 18, 19  
    Off . . . . . 18  
    Report . . . . . 18, 19  
  Orientation . . . . . 18, 19  
  Overlay . . . . . 18, 19  
  Print Instruction . . . . . 18  
  Print Quality . . . . . 18, 19  
  Paper Size . . . . . 18, 19  
  Paper Source . . . . . 18, 19  
  Print to File . . . . . 18, 19  
  Scale . . . . . 18, 19

Top Page . . . . . 18, 19  
Use Print Manager . . . . . 18, 19  
2 Up/4 Up . . . . . 18, 19

## H

Help . . . . . 18, 19, 25

## I

Image . . . . . 18, 19, 23  
Image Options screen . . . . . 23  
  Brightness . . . . . 23  
  Contrast . . . . . 23  
  Enable Photo Enhancement . . . . . 23  
Indicators . . . . . 9  
  ERROR . . . . . 9  
  READY . . . . . 9  
Installation  
  printer stands . . . . . 10  
  process unit . . . . . 10  
  software . . . . . 14  
Interface cable, parallel . . . . . 11  
Interface connector, parallel . . . . . 11, 40

## J

Jam . . . . . 32

## K

Software  
  disks . . . . . 8  
  installing . . . . . 14  
  removing . . . . . 16

## L

Labels . . . . . 12, 13, 38  
Landscape . . . . . 18, 19, 24, 25  
Left cover . . . . . 9

## M

Manual Duplexing . . . . . 18, 19  
Margins . . . . . 24, 25

## O

OHP Transparencies . . . . . 38  
Orientation . . . . . 18, 19, 24, 25  
  landscape . . . . . 18, 19, 24, 25  
  portrait . . . . . 18, 19, 24, 25  
Output tray . . . . . 9  
Overlay . . . . . 18-22  
Overlay Options screen . . . . . 20  
  Browse . . . . . 20  
  Print Cover Page . . . . . 20  
  Print Trailer Page . . . . . 20  
  Print Overlay . . . . . 20

# Index

## P

Paper . . . . .	12, 37
chute . . . . .	31
jam . . . . .	32
sizes . . . . .	37
support . . . . .	9, 12
tray . . . . .	9, 12
Parallel interface . . . . .	36, 40
cable . . . . .	11
connector . . . . .	11, 40
Part names . . . . .	9
PCL Control Panel . . . . .	24
Copies . . . . .	24, 25
Default Font . . . . .	24, 25
Form Feed . . . . .	24, 25
Margins . . . . .	24, 25
Orientation . . . . .	24, 25
Paper Size . . . . .	24, 25
Paper Source . . . . .	24, 25
Reset . . . . .	24, 25
PCL Mode . . . . .	24
Pinch roller . . . . .	31
Portrait . . . . .	18, 19, 24, 25
Power connector plug . . . . .	11
Power cord . . . . .	8, 11
Power on . . . . .	11
Power Saving Mode . . . . .	29
Power Source . . . . .	8
Power switch . . . . .	9, 11
Print Manager . . . . .	26, 27
Print Manager window . . . . .	26
File menu . . . . .	27
Add a document . . . . .	27
Delete documents . . . . .	27
Exit . . . . .	27
Pause Printer . . . . .	27
Resume Printer . . . . .	27
Options menu . . . . .	27
Priority (Low/Medium/High) . . . . .	27
Show Toolbar Titles . . . . .	27
12/24 Hour Format . . . . .	27
Progress bar . . . . .	26
Queue information . . . . .	26
Format . . . . .	26
Job name . . . . .	26
Size . . . . .	26
Time . . . . .	26
Size menu . . . . .	27
Show 5/10 Job Lines . . . . .	27
Status bar . . . . .	26
Print to File . . . . .	19
Printer stands . . . . .	10
Printing . . . . .	17
from a Windows application . . . . .	17
from a DOS application . . . . .	17
Print Modes . . . . .	17
GDI Mode . . . . .	18-23
PCL Mode . . . . .	24, 25
Process unit . . . . .	8, 9, 10, 33

## Q

Queue information . . . . .	26
-----------------------------	----

## R

Repacking . . . . .	33
Reset . . . . .	25

## S

Scale . . . . .	18, 19
Setup menu . . . . .	29
Show Me . . . . .	30
Specifications . . . . .	
envelopes . . . . .	39
interface . . . . .	40
paper . . . . .	37
printer . . . . .	36
Status Display . . . . .	28, 30
Status Display window . . . . .	28
File menu . . . . .	28
Options menu . . . . .	28
Animate icon . . . . .	28
Beep On Printer Error . . . . .	28
Beep When Print Job Is Complete . . . . .	28
Show Print Status Display When Printing . . . . .	28
Show Toolbar Title . . . . .	28
Setup menu . . . . .	29
Change Printer Settings screen . . . . .	29
Status messages . . . . .	30
Supplies . . . . .	35

## T

Testing the printer . . . . .	15
Toner cartridge . . . . .	35
TonrSavR Mode . . . . .	29
Top Page . . . . .	18, 19
Transfer roller . . . . .	31
Troubleshooting . . . . .	32
Tungsten wire . . . . .	31

## U

Use Print Manager . . . . .	18, 19
2 Up/4 Up Printing screen . . . . .	23
Draw Frame Border . . . . .	23
1 Up/2 Up/4 Up . . . . .	23

## V

Virtual memory . . . . .	8, 14
--------------------------	-------

## FOR USERS IN THE CONTINENTAL UNITED STATES ONLY

### Panasonic Warranty Policy

Your basic printer is covered by a limited 1 year parts and labor warranty. The Process Unit has a 90 day warranty or its rated life. (See operator's manual for rated life)

In addition, your printer is covered for the first 30 days under Panasonic's "Out of Box Failure" policy.

When you unpack your printer, you should find a process unit and power cord. If either/both of these parts are missing or defective,

**-or-**

If you have followed the set up instructions in this Operating Instructions manual and **the printer fails to turn on or "CALL SERVICE Exx" appears on the computer screen**, please call 1-800-222-0584. Identify yourself as having an "Out of Box Failure", so that the appropriate steps can be taken.  
(xx denotes a two digit number representing an error code)

---

**Panasonic Communications & Systems Company,  
Computer Products Division**  
**Division of Matsushita Electric Corporation of America**  
Two Panasonic Way, Secaucus, New Jersey 07094

**Panasonic Sales Company**  
**Division of Matsushita Electric of Puerto Rico, Inc**  
San Gabriel Industrial Park, 65th Infantry Avenue KM 9 5  
Carolina, Puerto Rico 00630

---

**Matsushita Electric of Canada Limited**  
5770 Ambler Drive, Mississauga, Ontario, L4W 2T3

---

**Matsushita Electric Industrial Co., Ltd.**  
Central P O Box 288, Osaka 530-91, Japan

---