

# Getting Started

(For 8-bit Multimedia Upgrade Kit)

Sony Interface

# BLASTER™

**Creative Labs, Inc.**  
1901 McCarthy Boulevard  
Milpitas CA 95035

**Creative Technology Ltd**  
67 Ayer Rajah Crescent #03-18  
Singapore 0513

Printed in Singapore

TWPP WK 12/94 0421600062

**CREATIVE**  
CREATIVE LABS

## Sound Blaster Pro Getting Started

---

Information in this document is subject to change without notice and does not represent a commitment on the Part of Creative Technology Ltd. The software described in this document is furnished under a license agreement and may be used or copied only in accordance with the terms of the license agreement. It is against the law to copy the software on any other medium except as specifically allowed in the license agreement. The licensee may make one copy of the software for backup purposes. No Part of this manual may be reproduced or transmitted in any form or by any means, electronic or mechanical, including photocopying and recording, for any purpose without the written permission of Creative Technology Ltd.

Copyright 1994 by Creative Technology Ltd. All rights reserved.  
Printed in Singapore.

Third Edition: April 1994

Sound Blaster Pro is a trademark of Creative Technology Ltd.  
IBM and PS/2 are registered trademarks of International Business Machines Corporation.  
MS-DOS is a registered trademark and Windows is a trademark of Microsoft Corporation.  
All other products are trademarks or registered trademarks of their respective owners.

---

## FCC Notice

This device has been tested and found to comply with the limits for a Class B digital device, pursuant to Part 15 of the FCC Rules. These limits are designed to provide reasonable protection against harmful interference in a residential installation. This device generates, uses, and can radiate radio frequency energy and, if not installed and used in accordance with the instruction, may cause harmful interference to radio communications. However, there is no guarantee that interference will not occur in a particular installation. If this device does cause harmful interference to radio or television reception, the user is encouraged to try to correct the interference by one or more of the following measures:

- Reorient or relocate the receiving antenna.
- Increase the separation between the computer and receiver.
- Connect the computer into an outlet on a circuit different from that to which the receiver is connected.
- Consult the dealer or an experienced radio/TV technician for help.

FCC ID : IBACT-SBP2S

---

## CAUTION

To comply with the limits for the Class B digital device, pursuant to Part 15 of the FCC Rules, this device must be installed in computer equipment certified to comply with the Class B limits. **All cables used to connect the computer and peripherals must be shielded and grounded.** Operation with non-certified computers or non-shielded cables may result in interference to radio or television reception.

---

## MODIFICATIONS

Any changes or modifications not expressly approved by the grantee of this device could void the user's authority to operate the equipment.

---

## Contents

### Introduction

#### Before You Begin

Checking System Requirements .....	xi
Obtaining Latest Information .....	xi
Making a Backup .....	xii
Using this Guide .....	xii
Document Conventions .....	xiii

### Knowing Your Audio Card

Jacks and Connectors .....	1-1
Line In Jack .....	1-2
Mic In Jack .....	1-2
Spk Out Jack .....	1-2
Joystick/MIDI Connector .....	1-2
16-bit Slot Connector .....	1-3
PC Spk Connector .....	1-3
CD In Connector .....	1-3
CD-ROM Interface Connector .....	1-4
Audio Extension Connector .....	1-3
Jumpers .....	1-4
Identifying Jumpers .....	1-4
Identifying the Jumper Locations .....	1-6
Knowing the Hardware Settings .....	1-7
I/O Addresses .....	1-7
IRQ Lines .....	1-9
DMA Channels .....	1-8
DMA Sharing .....	1-8
Joystick Port .....	1-8
Volume Control Knob .....	1-8

### Setting Up Your Audio Card

Checking the Hardware Settings .....	2-1
Installing the Card .....	2-2
Connecting External Speakers .....	2-4
Installing the Software .....	2-4
Testing the Installation .....	2-5

## Appendices

<b>General Specifications</b> .....	<b>A-1</b>
<b>Changing Hardware Settings</b> .....	<b>B-1</b>
A Closer Look at Your Hardware Settings .....	B-1
Changing Configuration of Jumpers .....	B-2
Changing the Settings .....	B-3
Changing Base I/O Address of Audio Interface .....	B-3
Changing the IRQ Line of Audio Interface .....	B-4
Changing the DMA Channel of Audio Interface .....	B-5
Enabling/Disabling DMA Sharing .....	B-6
Enabling/Disabling Joystick Port .....	B-6
Running the Configuration Utility .....	B-7
<b>Setting Environment Variables</b> .....	<b>C-1</b>
SOUND Environment Variable .....	C-1
BLASTER Environment Variable .....	C-1
MIDI Environment Variable .....	C-2
<b>A Closer Look at Your Internal Device Connectors</b> .....	<b>D-1</b>
CD In Connector Pin Assignments .....	D-1
PC Spk Connector Pin Assignments .....	D-2
Audio Extension Connector Pin Assignments .....	D-2
Redirecting PC Sounds to External Speakers .....	D-3
<b>Troubleshooting</b> .....	<b>E-1</b>
Problems in DOS .....	E-1
Problems in Windows .....	E-2
Problems with the Joystick .....	E-2
Problems with Sound .....	E-3
Resolving Hardware Conflicts .....	E-3
<b>Technical Support</b> .....	<b>F-1</b>

---

## Introduction

Congratulations on your purchase of our 8-bit audio card. With this card, you now have the capability to record and playback 8-bit digitized stereo audio. The built-in Mixer plus the external Volume Control Knob let you adjust the volume settings of your audio source to a level you desire. In addition, your audio card allows you to connect a Creative CD-ROM drive for endless hours of multimedia fun.

---

## Before You Begin

Before you begin setting up your package, you should read the following carefully:

- Checking System Requirements
- Obtaining Latest Information
- Making a Backup
- Using this Guide
- Document Conventions

---

## Checking System Requirements

You need to verify that your system meets the following requirements:

- IBM 286, 386, 486, or 100% compatibles.
- EGA or VGA card (VGA recommended).
- 4 MB of hard-disk space for the software.
- Windows 3.1 for Windows applications.

---

## Obtaining Latest Information

The README file on your audio diskette contains the latest information and changes not available at the time of printing. Please read the file before you continue. To view the file, insert the diskette in your disk drive and enter **README**.

---

## Making a Backup

If you have not made a backup copy of the original diskettes that come with your package, you should do so before installing the software in your system. Store your original diskettes in a safe place.

---

## Using this Guide

The Getting Started helps you install your audio card and accompanying software in the quickest way possible. It is organised as follows:

**Chapter 1** contains information on the various components and connectors of your audio card. If you are interested in knowing more about your card, you should read this chapter.

**Chapter 2** contains instructions on getting your audio card up and running.

**Appendix A** contains the general specifications of your audio card. These specifications present a list of the capabilities of the card.

**Appendix B** shows you how to change the hardware settings of your audio card. Refer to this appendix if you find that the hardware setting of your card needs changing.

**Appendix C** provides information on the environment variables of the audio card.

**Appendix D** shows you the pin definition of your internal connector. It also shows you how to redirect the PC sound to your external speakers.

**Appendix E** lists the problems that you may encounter while installing or using the audio card, and shows you how you can resolve them.

**Appendix F** shows you where to get technical support.

---



## Document Conventions

The information in this guide follows certain conventions that are adopted to help you locate and identify the information. These conventions are divided into keyboard conventions and notices.

The keyboard conventions, shown below, identifies the various types of keyboard input.

Convention	Used for
< >	The characters in the pointed brackets indicate symbols, letters and key names on the keyboard.
[]	Any text that you must supply.
<Key1+Key2>	The plus sign (+) between Key1 and Key2 means that both keys have to be pressed simultaneously. For example, "Press <Control+Z>" means that the <Control> and <Z> keys have to be pressed at the same time.
<Key1,Key2>	The comma (,) between Key1 and Key2 means that the keys have to be pressed in sequence. For example, "Press <C,Return>" means that you press the <C> key and release it, and then press the <Return> key and release it.
<i>Italic</i>	Any text that you must supply.

The notices, shown below, highlights areas of text that require your attention.

Convention	Used for
	Areas of text where the information or instructions must not be taken lightly and should be noted.
	Warnings.

## Installation Overview

This section is intended for the user who requires only a minimum amount of instructions to get the audio card installed. If you need more information, please refer to Chapter 2.

### GETTING STARTED

Installation is easy and fast. Just zoom down this slide to get your system blasting sound in no time.



### CONNECT EXTERNAL SPEAKERS

Connect speakers to SPK OUT jack on audio card.

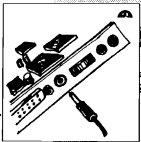

### TEST AUDIO CARD

Enter TEST-SBP from your sound directory.



### INSTALL AUDIO CARD

Switch off your system. Remove system cover and place card on a free 16-bit expansion slot.

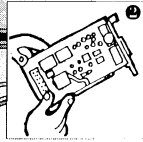

### INSTALL AUDIO CARD'S SOFTWARE

Switch on your system. Insert your Audio Card Disk #1 into the disk drive and enter INSTALL.

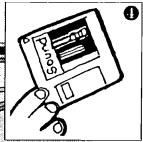

### USING YOUR SOUND SYSTEM

Read the accompanying documentation for information on making full use of your sound system.



# 1

## Knowing Your Audio Card

This chapter helps you locate and identify the components of your audio card. The components of the audio card are divided into the following categories:

- Jacks and Connectors
- Jumpers
- Volume Control Knob

## Jacks and Connectors

There are several jacks and connectors on the audio card. A jack is a one-hole connecting device for inserting a plug. Jacks are found exclusively on the card's rear panel. A connector is a connecting device consisting of many pairs of pins. Connectors are found on the audio card and its rear panel. The jacks and connectors on the audio card are shown in Figure 1-1.

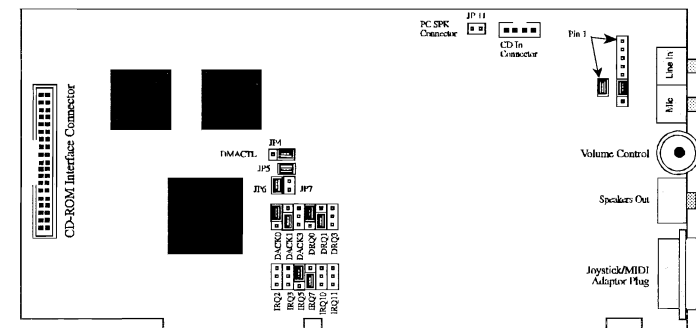

Figure 1-1: The jacks and connectors on the audio card.

---

## Line In Jack

The Line In Jack allows you to connect devices such as a cassette, DAT, or Minidisc player to the audio card for playback or recording.

---

## Mic In Jack

The Mic In Jack allows you to connect a microphone for voice input.

---

## Spk Out Jack

The Spk Out Jack allows you to connect speakers for audio output from the card's built-in power amplifier. The built-in amplifier has a maximum output power of four watts per channel from four-ohm speakers and two watts per channel from eight-ohm speakers. Do not play at maximum volume if your speakers cannot handle this power.

---

## Joystick/MIDI Connector

The Joystick/MIDI Connector allows you to connect a joystick or MIDI kit to the audio card.

The joystick port on the audio card is identical to that on a standard PC game control adapter or game I/O port. You can connect any analog joystick with a 15-pin D-sub connector. It also works well with any application that is compatible with the standard PC joystick. To use two joysticks, you need a Y-cable splitter.

If there is a game card in your system, it will conflict with the joystick port on your audio card. To avoid the conflict, remove either the game card or disable the joystick port on your audio card by removing the jumper block from JP4 (see Pg. B-6).

The MIDI kit contains a MIDI adapter with a joystick port so that you can plug in a joystick and a MIDI device simultaneously. The kit also comes with a sequencing software that allows you to record, playback, and edit MIDI files.

---

## 16-bit Slot Connector

The 16-bit Slot Connector allows you to install the audio card into your system. During installation, the audio card is inserted into a 16-bit expansion slot on your motherboard using this connector.

---

## PC Spk Connector

The PC Spk Connector makes it possible to redirect sounds that normally come from the PC speakers to the external speakers connected to the audio card (see Pg. C-2).

---

## CD In Connector

The CD In Connector allows you to connect the audio cable to the CD-ROM drive. With speakers connected to your audio card, you can listen to audio from the CD-ROM drive. (For more information, refer to your CD-ROM User's Guide.)

---

## CD-ROM Interface Connector

The CD-ROM Interface Connector allows you to connect a data cable to Sony CDU 31A or CDU 33A CD-ROM drive. Detailed instructions and the necessary cables are provided when you purchase the drive.

---

## Audio Extension Connector

The Audio Extension Connector allows you to connect other audio or video cards to your audio card. With this connection, you will be able to listen to the sounds generated from another card through your audio card.

---

## Jumpers

Jumpers, shown in Figure 1-2, are groups of pins that you can configure to define the hardware settings of your audio card.

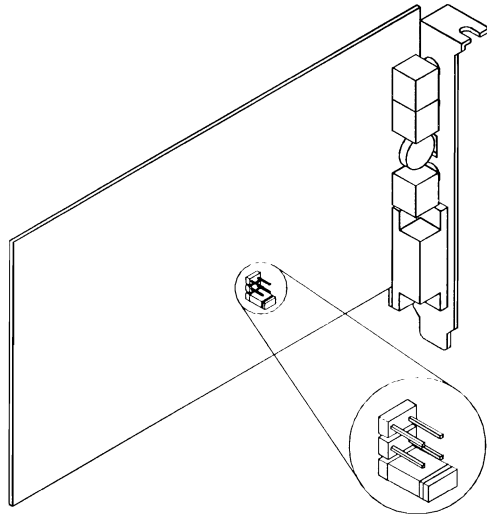

Figure 1-2: Jumpers.

---

## Identifying Jumpers

The jumpers found on your audio card are mainly two-pin jumpers which are either in the disabled or enabled state. A two-pin jumper is enabled when a jumper block is placed over it as shown in Figure 1-3.

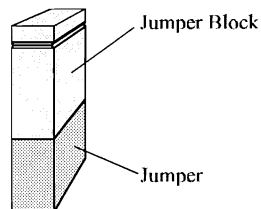

Figure 1-3: An enabled jumper.

You can identify a disabled two-pin jumper as one with no jumper block over it, or one with the jumper block over one pin as shown in Figure 1-4.

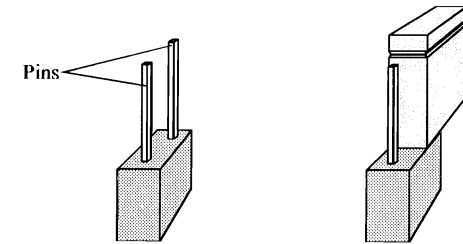

Figure 1-4: Two types of disabled jumpers.

The audio card also has jumpers with more than two pins. An example is the three-pin jumper for DMA sharing (see Figure 1-2).

You have to use the jumper block to enable certain pins on a jumper with more than two pins. For example, pins 2 and 3 of the three-pin jumper in Figure 1-5 are enabled.

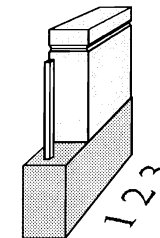

Figure 1-5: A three-pin jumper.



Certain hardware settings of the audio card require you to enable certain jumper(s) from a group of jumpers. An example of such a group of jumpers is shown in Figure 1-6.

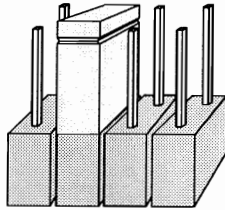

Figure 1-6: A group of four jumpers.

## Knowing the Hardware Settings

The jumpers on the card allow you to define the following hardware settings:

- I/O Addresses
- IRQ Lines
- DMA Channels
- DMA Sharing
- Joystick Port

## Identifying the Jumper Locations

The jumpers on your audio card are shown in Figure 1-7.

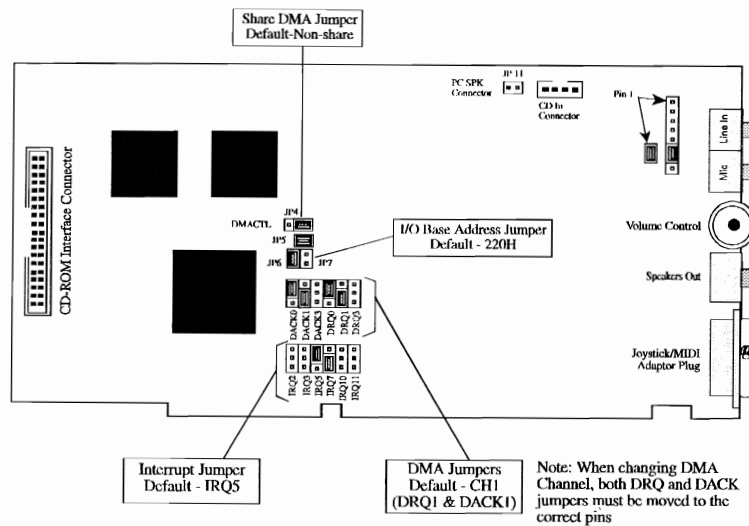

1-7: The location of jumpers on the audio card.

The  symbol indicates an enabled jumper or an enabled portion of a jumper.

## I/O Addresses

I/O addresses (or I/O address range) are areas of memory used by your computer's microprocessor to distinguish among various peripheral devices connected to your system when sending or receiving data. There are several such devices on the audio card. These devices are listed in the table below with the factory default I/O address range they occupy.

I/O Address Range	Usage
200H to 207H	Game Port
220H to 22FH	Audio Interface
230H to 237H	CD-ROM
388H to 38BH	FM Music Synthesizer

You can change the settings of only the Audio interface. However, to change the setting, you first need to know the interface's base I/O address.

The base I/O address is the starting address of the I/O address range. The factory default settings of the Audio interface is 220H.

## IRQ Lines

The IRQ (interrupt) line is the signal line your device uses to notify your computer's central processor that it wants to send or receive data for processing. Only the IRQ line of the Audio interface can be changed.

The factory default IRQ line setting of the Audio interface is 5.

---

### DMA Channels

The DMA (direct memory access) channel is the signal line your device uses to transfer data directly to the system's memory. The factory default setting of the DMA channel for the Audio interface is 1.

---

### DMA Sharing

The DMA Sharing allows your audio card to share the DMA channel with another peripheral device. The factory default setting disables DMA sharing.

---

### Joystick Port

The Joystick Port allows you to disable the joystick port on your audio card if you already have one in your system. The factory default setting enables the Joystick Port.

---

## Volume Control Knob

The Volume Control Knob allows you to adjust the volume of the speakers connected to the audio card. MIN and MAX are labels on the card that show you the direction to turn when decreasing or increasing the volume.



If you disable the internal amplifier, you cannot use the volume control. (see Pg. C-2).

---

# Setting Up Your Audio Card

This chapter guides you through the process of installing the audio card in your system. It also explains how to run the test program to ensure the card has been installed properly. This chapter is organized as follows:

- Checking the Hardware Settings
- Installing the Card
- Connecting External Speakers
- Installing the Software
- Testing the Installation

---

## Checking the Hardware Settings

Before you install the card in your system, you should take note of the following factory default settings on the card:

### Audio Interface

Base I/O address	:	220H
I/O address range	:	220H to 22FH
DMA channel	:	1
Interrupt	:	5
Joystick Port	:	Enabled

### CD-ROM Interface

Base I/O address	:	230H
I/O address range	:	230H to 237H

You will need to change the factory default settings of your audio card or another peripheral device on your system if any of the following occurs:

- A peripheral device uses the same I/O addresses, DMA channel, or interrupt setting as your card (known as a hardware conflict).
- An external amplifier is used for audio output.
- Joystick/Game Port is used by your system.



It is advisable that you do not change the audio card's default settings. If you need to change these settings, you should do so before installing the card in your system (see Appendix B).

## Installing the Card

Installing the audio card in your system is simple, so please follow the instructions carefully.

To install the card:

1. Switch off your system and all peripheral devices, and unplug the power cord from the wall outlet.

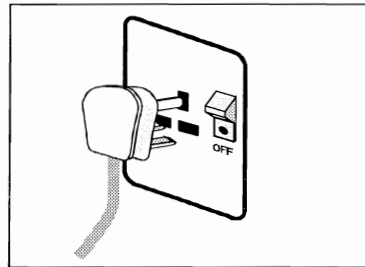

2. Touch a metal plate on your system to ground yourself and discharge any static electricity.

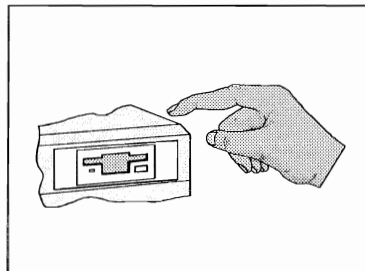

3. Remove the cover from your system.

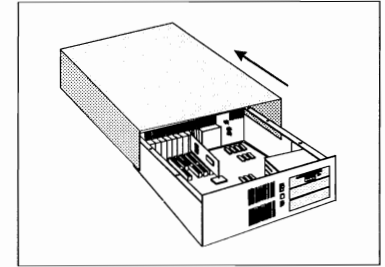

4. Find a free 16-bit expansion slot in your system.

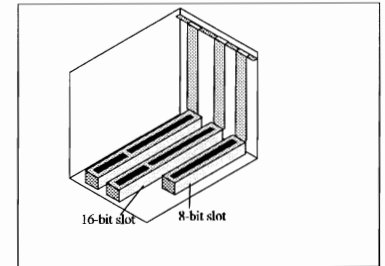

5. Remove the metal plate from the slot you have chosen and put the screw aside.

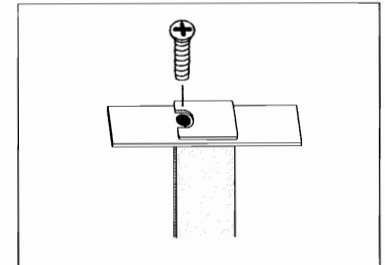

6. Align the card's 16-bit slot connector with the expansion slot and gently lower the card into the free slot as shown.

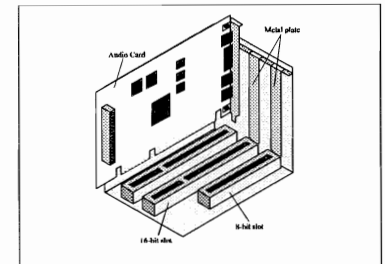

- Secure the card to the expansion slot with the screw you removed from the metal plate.



If your package comes with a CD-ROM drive, do not replace your system's cover until you have installed the drive in your system.

- Replace the cover of your system and switch it on.

## Connecting External Speakers

Once the audio card has been installed on your system, connect the speakers to your audio card.

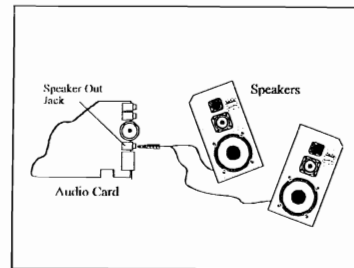

## Installing the Software

Several DOS and Windows applications are provided with the package that comes with your audio card. If you have Windows 3.1 and have not installed it, it is advisable that you install it before installing your audio card's software.

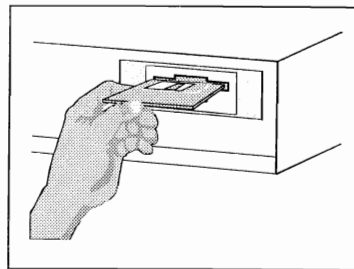

To install the software:

- Insert your Audio Card Installation Disk into your disk drive.
- Change to the drive containing the disk.
- Type **INSTALL** and press <Enter>.
- Follow the instructions on the screen to complete the installation.

The installation program will store the software into the directory you specify or the default \SBPRO. It also adds the following to

**AUTOEXEC.BAT** file  
 SET BLASTER=A220 I5 D1 T4  
 SET SOUND=C:\SBPRO  
 C:\SBPRO\SBPSET /P

**CONFIG.SYS** file  
 DEVICE=C:\SBPRO\DRV\CTSBPRO.SYS /UNIT=0 /BLASTER=A:220  
 I:5 D:1  
 DEVICE=C:\SBPRO\DRV\CTMMSYS.SYS



Refer to Appendix C, "Setting Environment Variables" for a description of the SOUND and BLASTER environment settings.

When you run the installation program, it installs the DOS and Windows applications onto the hard disk. The program also allows you to setup your Windows application by adding a command to the WIN.INI file to run WINSETUP.EXE. The command automatically creates the audio card group window and the application's icon when you run Windows the next time. You can also choose to setup your Windows applications and drivers at a later time by running INSTALL from your sound directory.

## Testing the Installation

Once you have installed the card, run the test program DIAGNOSE to make sure the card has been installed properly. This program checks the base I/O address, interrupt, and DMA channel used by the Audio interface, and then displays a menu to let you test the card's sound and music output.

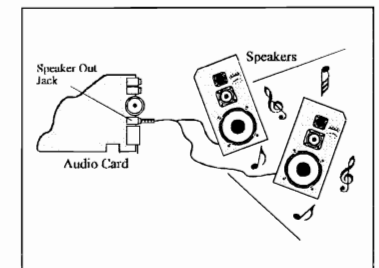

To run the test program:

- Change to your sound directory.
- Type **DIAGNOSE** and press <Enter>.
- Follow the instructions on the screen to complete the test.

If the test program stops or displays an error message when it is checking the Audio interface's base I/O address, interrupt, and DMA channel, it may be due to a conflict between the audio card and another peripheral card. To resolve the conflict, you have to change the settings of your audio card. (See Appendix B on how to change the settings and resolve the conflicts.)

If there is no sound output during the test, check the following:

- Speakers are connected to the card's audio output connector.
- Volume control knob is set at mid-range.
- No hardware conflicts between the audio card and another peripheral card.



The built-in stereo power amplifier has a maximum output power of four watts per channel for four ohm speakers and two watts per channel for eight ohm speakers. Do not play at maximum if your speakers cannot handle this power.



---

## General Specifications

**FM stereo music synthesizer producing 20 voices with 2 FM operators.**

**Built-in 4 watts stereo power amplifier that can drive the headphones or speakers.**

### **Stereo digitized audio playback capability**

- Plays back all kinds of digitized sounds such as speech, music and special effects through the two 8-bit Digital-to-Analog Converters (DACs).
- Variable sampling rate from 4 kHz to 44.1 kHz.
- Hardware ADPCM decompression (2:1, 3:1, and 4:1).
- DMA or CPU transfer mode.

### **Stereo digitized audio record capability**

- Digitizes and records any kind of sound through the microphone, line-in, and CD-audio.
- Sampling rate from 4 kHz to 44.1 kHz (mono) or 11 kHz to 22.05 kHz (stereo)
- DMA transfer mode.

### **Built-in Digital/Analog Mixer**

- Software programmable digital/analog mixer.
- Mixes stereo DAC, FM music, CD-audio, Line-In, Microphone input, and Master Volume during playback.

### **Built-in Microphone Jack and Amplifier**

- Automatic Gain Control that automatically adjusts sound input level.

### **Built-in Master Volume Control**

# B

## Changing Hardware Settings

This appendix shows you how to change the configuration of the jumpers on the card and run DIAGNOSE, a program that allows you to update the various system files after you change the settings of your card.

 Because many applications are designed to work with these default settings, you should not change the settings unless it is absolutely necessary (for example, resolving hardware conflicts).

### A Closer Look at Your Hardware Settings

If you intend to change the hardware settings of your audio card, you should first become more familiar with the jumpers on the card shown in Figure B-1.

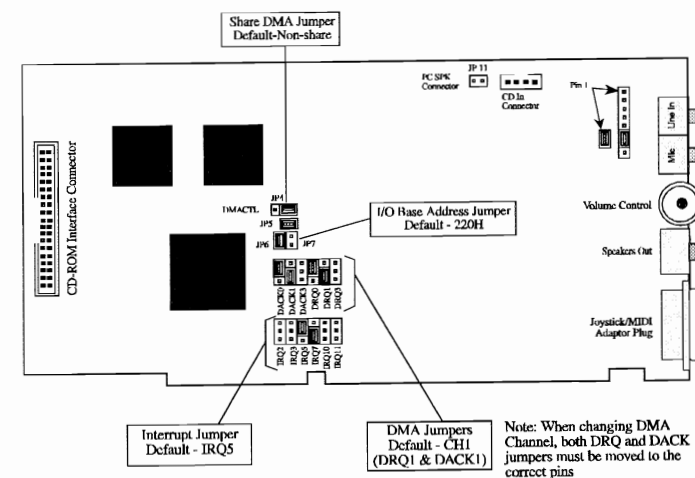

Figure B-1: Jumpers on the audio card.

#### Software Selectable Sound Input

- Microphone input (mono)
- Line input (mono or stereo)
- CD-audio (mono or stereo)

#### CD-ROM Interface

- Built-in CD-ROM interface that supports Sony CDU 31A or CDU 33A CD-ROM drive

#### Joystick Port

- Built-in standard Game I/O port for PC analog joystick.

#### MIDI Interface

- Built-in MIDI interface for connection to MIDI instruments or keyboards (MIDI Kit required).
- 64-byte FIFO buffer for high speed transfer.

In this guide, the disabled and enabled jumpers are represented using blocks as shown in Figure B-2.



Figure B-2: Representation of disabled (left) and enabled (right) jumpers.

## Changing Configuration of Jumpers

Jumper configurations define the hardware settings of the audio card. Before you actually change a jumper configuration, you should identify the current setting and the setting you want to change to. You can then proceed to change the jumper configuration.

To change the configuration of jumper(s):

1. Switch off your computer and all other peripheral devices.
2. Remove the system's cover and card from your system.
3. Identify the jumper(s) to change.

For more information on how to identify the jumpers, refer to the Figure B-1.

4. Remove the jumper block(s) from the jumper(s) as shown in Figure B-3.

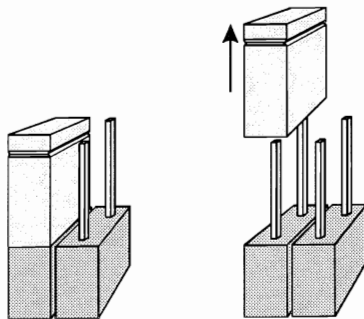

Figure B-3: Removing the Jumper Block.

5. Select the settings for the card by placing the jumper block(s) on the desired jumper(s) as shown in Figure B-4.

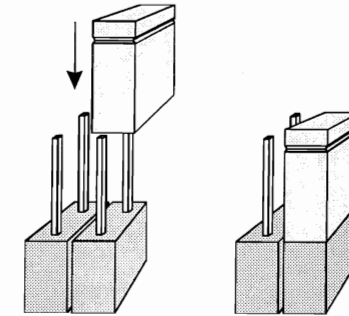

Figure B-4: Inserting the Jumper Block.

## Changing the Settings

This section will describe the settings available for changing the settings of the following:

- Base I/O Addresses
- IRQ Lines
- DMA Channels
- DMA Sharing
- Joystick Port

### Changing Base I/O Address of Audio Interface

Two base I/O addresses are available for the Audio interface: 220H (factory default setting) and 240H. These settings are shown below with their I/O address range.

Base I/O Address	I/O Address Range
220H (default)	220H to 22FH
240H	240H to 24FH

The default base I/O address is represented in Figure B-5.

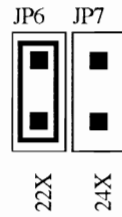

Figure B-5: The default base I/O address setting of Audio interface.

To change the base I/O address, enable the jumper corresponding to the setting shown below.

Base I/O Address	Enable Jumper
220H	JP6
240H	JP7

### Changing the IRQ Line of Audio Interface

Four interrupts are available for the Audio interface: 2, 5 (factory default setting), 7, and 10. The default interrupt is represented in Figure B-6.

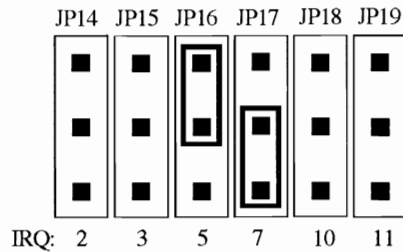

Figure B-6: The default interrupt setting for Audio interface.

To change the interrupt, enable the jumper corresponding to the setting shown below.

Interrupt	Enable Jumper
2	JP18
5 (default)	JP19
7	JP20
10	JP21

### Changing the DMA Channel of Audio Interface

Three DMA channels are available for the Audio interface: 0, 1 (factory default setting), and 3. The DMA channel is determined by two jumpers, one for the DRQ setting and the other for the DACK setting. Both settings must be the same as illustrated by the default DMA channel representation in Figure B-7.

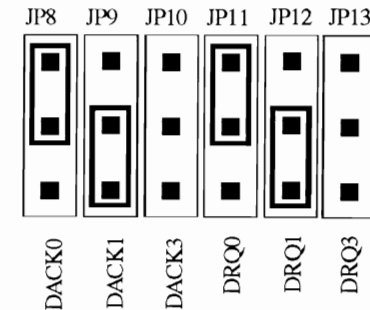

Figure B-7: The default DMA channel setting for Audio interface.

To change the DMA channel, enable the jumpers corresponding to the setting shown below.

DMA Channel	Enable Jumpers
0	JP5 and JP15
1 (default)	JP6 and JP16
3	JP7 and JP17



## Enabling/Disabling DMA Sharing

This audio card can share the DMA channel with another peripheral device. Sharing is controlled by the DMACTL pins specified by jumper JP4. The factory default setting prevents the sharing of DMA channel with another peripheral device and is shown in Figure B-8.



Figure B-8: Disable DMA sharing setting.

To enable DMA sharing, enable pins 2 and 3 of jumper JP11 as shown in Figure B-9.



Figure B-9: Enable DMA sharing setting.

## Enabling/Disabling Joystick Port

The Joystick Port on the audio card can be enabled/disabled using jumper JP4. The factory default setting of the Joystick Port is enabled. If you have a Joystick Port in your system, you should disable the one on your audio card.

To change the Joystick Port setting, enable or disable jumper JP4 as shown below.

Joystick Port State	JP4 State
Disabled	Disabled
Enabled (default)	Enabled

## Running the Configuration Utility

When you change the hardware settings on the card, you need to update the system files—AUTOEXEC.BAT, CONFIG.SYS, and SYSTEM.INI—with the new settings. You can also use SBConfiguration or DIAGNOSE to change and update the settings in Windows or DOS. DIAGNOSE also allows you to test the audio output (see Chapter 2).

To run SBConfiguration:

1. Double-click the SBConfiguration icon in the audio card group window.  
The Sound Blaster Configuration dialog box similar to Figure B-10 appears.

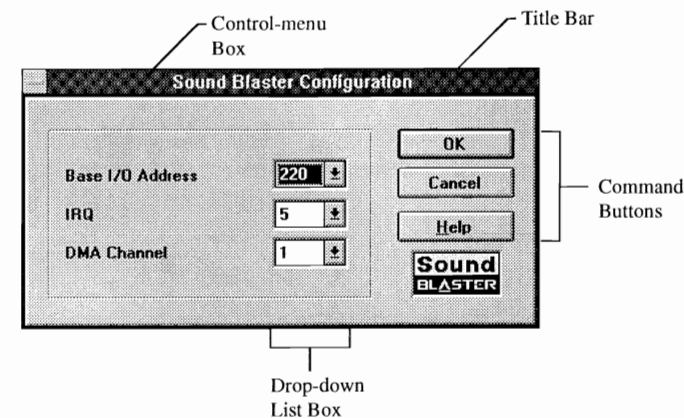

Figure B-10: The Sound Blaster Configuration dialog box.

2. Click to select from the drop-down list. The drop-down list appears.
3. Select the settings desired.
4. Repeat steps 2 and 3 for the rest of the settings desired.
5. Choose one of the followings:
  - To save the new settings, choose OK, or
  - To quit without saving the new settings, choose Cancel.

When prompted to select the base I/O address of the Audio interface, you should select the ones that match those on the card. Remember to reboot your system for the changes to take effect.

To run DIAGNOSE:

1. Change to your sound directory.
2. Type **DIAGNOSE** and press <Enter>.
3. Follow the instructions on the screen.  
For more information, type **DIAGNOSE/?** and press <Enter>.

If you run DIAGNOSE with the /s switch from the DOS prompt, it reads the BLASTER environment for the settings on the card and programs the card with those settings. Take note that it does not modify your system files. You can also put DIAGNOSE/s after the SET BLASTER entry in the AUTOEXEC.BAT file if you do not want to load CTSBPRO.SYS during bootup.

# C

---

## Setting Environment Variables

In order for your audio card to work, several of its parameters must be specified in your system during bootup. This is done by setting three environment variables SOUND, BLASTER, and MIDI in memory. They are described below.

---

### SOUND Environment Variable

The SOUND environment variable specifies the directory location of your audio card's drivers and software. The command for setting the SOUND environment variable is as follows:

```
SET SOUND=<path>
```

where <path> is the drive and directory of your audio card's software (eg. C:\SB16)

Note that there is no space before and after the equal (=) sign.

---

### BLASTER Environment Variable

The BLASTER environment variable specifies the base I/O address, interrupt number, and DMA channel hardware configuration of your audio interface. The command for setting the BLASTER environment variable is as follows:

```
SET BLASTER=A220 I5 D1 H5 P330 T6
```

Note that there is no space before and after the = (equal) sign, but there must be at least one space between two settings.

The settings for the parameters in the command are described below.

Parameter	Description
Axxx	Specifies the audio interface's base I/O address. xxx can be 220, 240, 260, or 280.
Ix	Specifies the interrupt request line used by the audio interface. x can be 2, 5, 7, or 10.
Dx	Specifies the Low DMA channel used by the audio interface. x can be 0, 1, or 3.
Hx	Specifies the High DMA channel used by the audio interface. x can be 5, 6, or 7.
Pxxx	Specifies the MPU-401 interface's base I/O address. xxx can be 300 or 330.
Tx	Specifies the card type. x must be 6.

## MIDI Environment Variable

The MIDI environment variable specifies the MIDI file format used and where the MIDI data is sent to. The MIDI data can be sent to FM chips or MIDI port.

Generally, there are three MIDI file formats available in the market, General MIDI, Extended MIDI and Basic MIDI. The command for setting the MIDI environment variable is as follows:

```
SET MIDI=SYNTH:x MAP:x
```

The parameters of the command are described below.

Parameter	Description
SYNTH	x can be 1 or 2. If it is 1, the internal synthesizer is specified. If it is 2, the MIDI port is specified. The factory default for x is 1.
MAP	x can be G, E, or B. If it is G, the General MIDI file format is specified. If it is E, the Extended MIDI file format is specified. If it is B, the Basic MIDI file format is specified. The factory default for x is E.

# D

## A Closer Look at Your Internal Device Connectors

You may want to internally connect your audio card to other devices on your system (such as another audio card), or simply redirect the "beeps" that you hear from your system to your external speakers. This section will define the pins of each internal connector on your audio card. It will also show you how to redirect the PC sounds to your external speakers.



Read this section only if you are an advanced user who knows how to use the pin assignments. If you want to redirect sound, you should also be familiar with your system's motherboard and know where to find your system's internal speaker.

### CD In Connector Pin Assignments

The CD In Connector has the following pin assignments:

Pin	Signal	I/O
1	Ground	IN
2	CD Left Channel	IN
3	Ground	IN
4	CD Right Channel	IN

## PC Spk Connector Pin Assignments

The PC Spk Connector has the following pin assignments:

Pin	Signal	I/O
1	+5V	IN
2	Spk	IN

## Audio Extension Connector Pin Assignments

The following is the pin assignments of the Audio Extension Connector:

Connector JP2		
Pin	Description	
1	MICR	Mic input : Right channel. Input ranges from 0.004 to 0.7 V rms.
2	MICGEN	Mic input : Ground
3	MICL	Mic input : Left channel. Input ranges from 0.004 to 0.7 V rms.
4	SPKGND	Speaker output: Ground
5	SPKR	Speaker output: Right channel. Maximum output voltage is 3 V rms at 4 ohms.
6	SPKL	Speaker output: Left channel. Maximum output voltage is 3 V rms at 4 ohms.
7	SPKRL	Speaker output return signal : Left channel
8	SPKRR	Speaker output return signal : Right channel

Connector JP3		
Pin		Description
1	SPKR	Speaker output : Right channel. Maximum output voltage is 3 V rms at 4 ohms.
2	SPKR	Speaker output return signal : Right channel.

## Redirecting PC Sounds to External Speakers

It is possible to redirect the sounds that normally come from your computer's speaker to the speakers connected to the audio card.



If you not know how to perform this process, seek the help of an experienced technician.

To redirect PC sounds to external speakers:

1. Locate the PC speaker connection on the motherboard.
2. Remove the speaker connection from the motherboard.
3. From the motherboard, connect a wire from the +5Vdc pin on the speaker connector to pin 1 of the PC Spk Connector on the audio card.
4. Connect another wire from the Data-Out pin on the motherboard speaker to pin 2 of the PC Spk Connector on the card.

# E

---

## Troubleshooting

This appendix provides some tips and strategies for some of the problems you might encounter with the audio card either during installation or normal use.

---

### Problems in DOS

- Problem** Sound or/and Blaster environment string could not be found.
- Cause** The command to set up the Sound or/and Blaster environment may not be included in the AUTOEXEC.BAT file. The Sound environment specifies the directory location of the audio card while Blaster environment specifies the I/O address, interrupt, and DMA channel settings of the Audio interface. Both environment strings need to be set up in the DOS environment. When you install the audio card's software, the commands to set up the environment are automatically added to the AUTOEXEC.BAT file so that both environment strings are set up whenever your system is started or restarted. Whenever changes to the environment strings are made, it is advisable that the changes are reflected in the AUTOEXEC.BAT file. The sound environment is SOUND=C:\SBPRO (if default is used) while the Blaster environment is BLASTER=A220 I5 D1 T4.
- Solution** To add the command to set up the Sound environment in the AUTOEXEC.BAT file, use a text editor such as MS-DOS Editor. To add the command to set up the Blaster environment in the AUTOEXEC.BAT file, run **DIAGNOSE** at the \SBPRO directory (if default is used). Remember to reboot the system for the new settings to take effect. Refer to Appendix C, "Setting Environment Variables" for a description of the environment strings.

---

## Problems in Windows

- Problem** No sound when running some Windows applications.
- Cause** One or more of the sound drivers may not be included in the SYSTEM.INI file.
- Solution** Check the SYSTEM.INI file by following the steps below:
1. Select Run from Program Manager's File menu.
  2. Type **SYSEEDIT** in the Command Line text box and choose OK.

You should see the following:

```
[drivers]
timer=timer.driv
midimapper=midimap.driv
Aux=sbpaux.driv
MIDI=sbp2fm.driv
Wave=sbpsnd.driv
MIDI1=sbpsnd.driv
```

```
[sndblst.driv]
port=220
int=5
dmachannel=1
```

If one or more of the drivers are missing, run INSTALL (see Chapter 2).

---

## Problems with the Joystick

- Problem** Joystick is not working.
- Cause** The joystick port on the audio card conflicts with the existing joystick port in your system.
- Solution** Remove either the additional joystick in your system or disable the joystick port on the audio card by removing the jumper block from JP4.
- Problem** Joystick is working erratically in some programs.
- Cause** The CPU speed of your system is too fast.
- Solution** Some applications depend on the CPU timing to calculate the joystick position. One solution is to reduce the speed of your system.

---

## Problems with Sound

- Problem** Background noise from speakers or headphones.
- Cause** The noise from the computer power supply may be picked up and amplified to an audible level when the power amplifier is set at a high level.
- Solution** Lower the level of the volume. If a louder volume is desired, try to amplify the sound using an external amplifier.
- Problem** No sound.
- Cause** Audio equipment is not connected properly or the volume is not adjusted to an audible level.
- Solution** Check to see that your speakers or headphones are connected to the correct connector on the audio card and the volume control knob is set to mid-range. If you are using powered speakers, make sure that your speakers are plugged into an AC outlet and the speakers are turned on.

---

## Resolving Hardware Conflicts

Hardware conflicts occur when two or more peripheral devices contend for the same signal lines or channels. Conflicts between the audio card and another peripheral device might be due to the settings of the base I/O addresses, interrupts, or DMA channel.

The Audio interface's factory default settings are:

Base I/O address	:	220H
Interrupt	:	5
DMA channel	:	1

To resolve hardware conflicts:

1. Change the hardware settings of the audio or peripheral card in your system if the peripheral card is using the audio card's setting. (See Appendix B on how to change the hardware settings of the audio card.)
2. If you are unsure of the settings of the peripheral cards, you can isolate the source of the problem by temporarily removing all cards except the audio card and other essential cards such as disk controller. After that, add the card back one at a time until the card that is causing the conflict is found.

---

## Technical Support

We are committed to giving you the best product as well as technical support. When you call, fax or write, please have the following information:

- Base I/O address used by your card.
- Error message on the screen and how it came about.
- Information on the adapter card that conflicts with your card.

Inside U.S.A., Canada and South America, contact:

**CREATIVE LABS, INC.** Technical Support  
1523 Cimarron Plaza, Stillwater, OK 74075. U.S.A.  
Tel : (405) 742 6622  
Fax : (405) 742 6633  
BBS : (405) 742 6660

Operating Hours (U.S.A. Central Time)  
Mon-Sun : 8:00 am-10:00 pm  
Public Holidays : Closed

Outside USA, Canada and South America, contact:

**CREATIVE TECHNOLOGY LTD.** Technical Support  
67 Ayer Rajah Crescent, #03-18. Singapore 0513.  
Tel : (65) 870 0433  
Fax : (65) 773 0353  
BBS : (65) 776 2423

Operating Hours (Singapore Time)  
Mon-Fri : 9:00 am-6:00 pm  
Sat : 9:00 am-1:00 pm  
Sun & Public Holidays : Closed