

Finding Your Way around the System

You've bought your new computer and taken everything out of the box. Now you may be asking yourself, "OK, what do I do?" Well, this chapter helps you set up your computer, gives you tips on working comfortably and takes you on a tour of the computer's features.

Make Sure You Have Everything

Your Satellite 200 Series computer comes with everything you need to get up and running quickly. However, before you rush off, it's a good idea to make sure you received everything you were supposed to. This information is listed on the Quick Start Card at the top of the box.

If any items are missing or damaged, notify your dealer immediately. For additional help, contact Toshiba as described in "If You Need Further Assistance" on page 296.

Select a Place To Work

The Satellite 200 Series is a portable computer, designed to be used in a variety of circumstances and locations. However, by giving some thought to your work environment, you can protect the computer and make your work hours more comfortable.

Keep the Computer Comfortable

Use a flat surface with enough room to operate comfortably. If you're planning to use a printer or other external device, make sure there's enough space for it as well.

To keep your computer in prime operating condition, make sure your work area is free from:

- ❖ dust, moisture and direct sunlight.
- ❖ liquids and corrosive chemicals.



Don't spill liquids into the computer. If you spill a liquid into the keyboard, turn the computer off, unplug it from the AC power source, and let it dry completely before turning it on again.

If the computer does not operate correctly after you turn it back on, contact a Toshiba authorized service provider.

- ❖ objects that generate a strong electromagnetic field, such as stereo speakers (except ones you have connected to the computer) or speakerphones.
- ❖ rapid changes in temperature or humidity and sources of temperature changes, such as air conditioner vents or heaters.
- ❖ extreme heat, cold or humidity. Operate the computer within a temperature range of 41 to 95 degrees Fahrenheit (5 to 35 degrees Celsius) and a relative non-condensing humidity of 20 to 80 percent.

Keep Yourself Comfortable

Strain and stress injuries are becoming more common as people spend more time using their computers. However, with a little care and proper use of the equipment, you can work comfortably throughout the day.



Using the computer keyboard incorrectly can result in discomfort and possible injury. If your hands, wrists, and/or arms bother you while typing, discontinue using the computer and rest. If discomfort persists, consult a physician.

In addition to the hints provided in the following sections, there are a number of books available on ergonomics, repetitive strain injury, and repetitive stress syndrome.

Placement of the Computer

Proper placement of the computer and external devices is important to avoid stress-related injuries:

- ❖ Place the computer on a flat surface at a comfortable height and distance. Your arms and hands should be in a relaxed position with your forearms parallel to the floor. The top of the display should be no higher than eye level.
- ❖ Maintain good posture with your body relaxed and your weight distributed evenly. You should be able to type without twisting your torso or neck, and see the display panel without slouching.
- ❖ Adjust the display panel to avoid glare.
- ❖ If you use a paper holder, set it at about the same height and distance as the computer.

Seating and Posture

Proper seating is one of the primary factors in reducing work strain. Some people find a backless chair more comfortable than a conventional chair. Whichever type you choose, refer to the following guidelines to adjust your chair for maximum computing comfort.

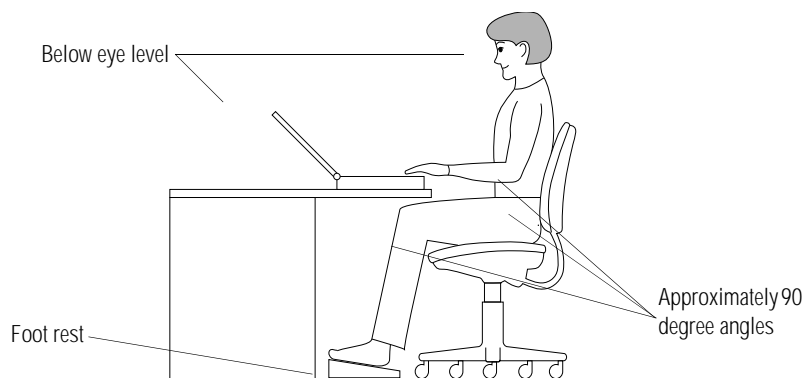

Correct posture and positioning of the computer

- ❖ Position your chair so the keyboard is at or slightly below the level of your elbow. You should be able to type comfortably with your shoulders relaxed.

If you are using a conventional chair:

- ❖ Your knees should be slightly higher than your hips. If necessary, use a foot rest to raise the level of your knees and ease the pressure on the back of your thighs.
- ❖ Adjust the back of your chair so it supports the lower curve of your spine. If necessary, use a cushion to provide extra back support. Lower back support cushions are available at many office supply stores.
- ❖ Sit with your back straight so that your knees, hips and elbows form approximately 90 degree angles when you work. Do not slump forward or lean back too far.

Lighting

Proper lighting can improve the legibility of the display and reduce eye strain.

- ❖ Position the display panel so that sunlight or bright indoor lighting does not reflect off the screen. Use tinted windows or shades to reduce glare.
- ❖ Avoid placing your computer in front of a bright light that could shine directly in your eyes.
- ❖ If possible, use soft, indirect lighting in your computer work area.

Arms and Wrists

- ❖ Avoid bending, arching, or angling your wrists. Keep them in a relaxed, neutral position while typing.
- ❖ Exercise your hands, wrists and arms to improve circulation.

Work Habits

The key to avoiding discomfort or injury from repetitive strain is to vary your activities. If possible, schedule a variety of tasks into your work day. Finding ways to break up the routine can reduce stress and improve your efficiency.

- ❖ Take frequent breaks to change position, stretch your muscles, and relieve your eyes.
- ❖ Avoid performing repetitive activities for prolonged periods of time. Vary activities from one task to another.
- ❖ Focusing your eyes on your computer screen for long periods of time can cause eye strain. Look away from the computer frequently and focus your eyes on a distant object.

Find Out Where Everything's Located

If you've never used a notebook computer before, you're probably wondering how an entire computer can fit into so small a case. The next few pages take you on a guided tour of the computer and its components.

Rather than reading through this section, you may prefer to use it as a reference as you move through the remainder of the manual and need to locate specific parts of the computer.

This information is also available in the electronic form of this manual, described in “Using The Electronic Guide” on page 40.

Don't worry if you don't know what some parts of the computer do. Some items in this tour are for more advanced computing functions that you may want to use as your computing needs and skills increase.

The Front with the Display Closed

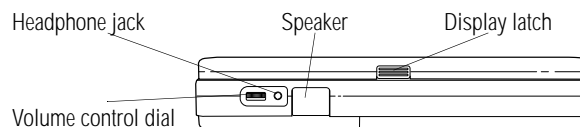

The front with the display closed

Pressing the **display latch** opens the computer's display panel. For more information, see “Open the Display” on page 26.

▲ The **volume control dial** lets you adjust the loudness of the system speaker.

■ The 3.5 mm **headphone jack** lets you connect stereo headphones or other audio output devices, such as external speakers. Connecting headphones or other devices to this jack disables the internal speaker automatically.

The **speaker** lets you hear system alarms and sounds associated with your software. For more information, see “Using External Speakers or Headphones” on page 160.

The Left Side

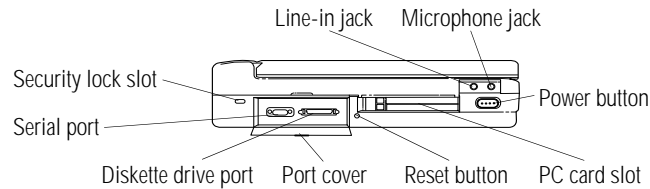

The left side

The port cover protects the serial port and diskette drive port.



The **serial port** lets you connect a serial mouse, printer or other serial device. For more information, see “Using an External Modem” on page 187.



The **diskette drive port** lets you connect the external 3.5-inch diskette drive if you have a CD-ROM drive module installed in the computer's SelectBay™.



Pressing the **reset button** restarts the computer. Use this button if all other attempts at restarting the computer have failed.



Attaching a special cable to the **security lock slot** lets you anchor your computer to your desk or other large, heavy object. For more information, see “Applying Physical Restraints” on page 238.



Pressing the **power button** turns the computer on and off. For more information, see “Turn the Computer On” on page 27.



<<illustrationleftmargin pcmcia.bmp>>The **PC card slot** lets you install up to two Type I or Type II, or one Type III PCMCIA-compatible PC cards. For more information, see “Little Cards That Do Big Things” on page 173.



The 3.5 mm **microphone jack** lets you connect an external monaural microphone or other audio input device. Connecting a microphone or other device to this jack disables the internal microphone automatically.



The **line-in jack** lets you play and record stereo sound from an external audio device, such as a stereo system.

The Back

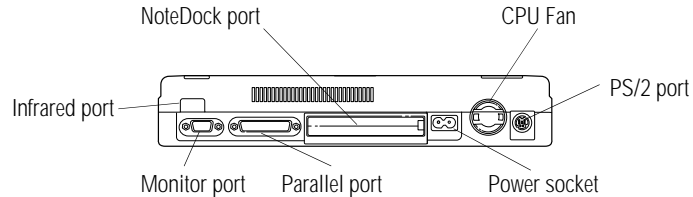

The back



The **PS/2 port** provides access to an optional external PS/2-compatible mouse or keyboard. For more information, see “Using an External Keyboard” on page 215.



The **monitor port** allows you to connect an external monitor. For more information, see “Using an External Monitor” on page 211.



The **NoteDock™ port** allows you to connect the optional NoteDock. The NoteDock provides all the ports of the Satellite 200 Series computer and a PS/2 keyboard port, PS/2 mouse port, line-out jack, joystick/MIDI port, and two additional type III PC Card slots. For more information, see “Using the Optional NoteDock” on page 223.



Keep foreign objects away from this port. Pins and other small objects can slip inside the port and damage computer circuitry.



The **power socket** is where you plug in the power cord. For more information, see “Connect to a Power Source” on page 15.



The **parallel port** lets you connect a printer or other parallel device, including ECP-compatible devices. For more information, see “Connecting a Parallel Printer” on page 24.



The serial **infrared port** allows cableless communication with a computer, printer or other device that has an infrared port. For information about using the infrared port, see “Transferring Files to Another Computer” on page 99.

The **CPU fan** prevents the computer’s central processing unit (CPU) from overheating so it can continue to perform at its maximum speed. You also have the option of reducing speed to avoid the use of the fan.



To prevent possible overheating of the CPU, make sure you don't block the fan.

The Right Side

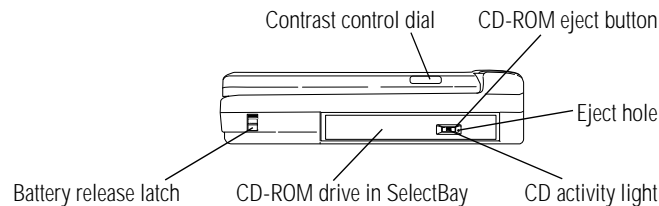

The right side

The **battery release latch** prevents the battery from falling out accidentally. This release is locked when it is moved down. For more information, see “Replacing Batteries” on page 136.

The **SelectBay™** holds either a **CD-ROM drive** or diskette drive. An external drive chassis holds the diskette drive when it’s not currently installed. For more information about the SelectBay, see “Swapping Drives in the SelectBay” on page 104.

The **CD activity light** glows when the system is accessing a disc in the CD-ROM drive.

The **CD-ROM eject button** opens the 5.25-inch CD-ROM drive in the SelectBay when the computer’s power is on.

The **eject hole** provides a way for you open the CD-ROM drive when the computer's power is off. If you left a compact disc inside and have already turned the power off, insert a large straightened paper clip in this slot to release the catch and open the drive.



The **contrast control dial** adjusts the contrast of the display.

The Underside

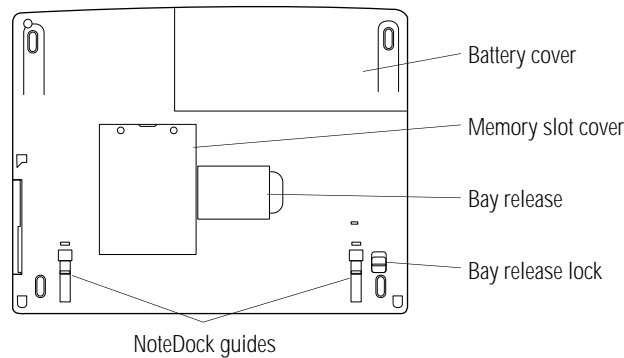

The underside



The **memory slot cover** protects a slot for adding extra memory to your computer. For more information, see “Adding Memory (Optional)” on page 16.

The **battery** provides power to the computer when you're not using a wall outlet. For information about replacing the battery, see “Replacing Batteries” on page 136.

The **bay release** lets you remove the drive in the SelectBay. For more information about switching drives in the SelectBay, see “Swapping Drives in the SelectBay” on page 104.

The **bay release lock** prevents accidental removal of the drive in the SelectBay.

The **NoteDock guides** help align the optional NoteDock. For more information, see “Using the Optional NoteDock” on page 223.

The Front with the Display Open

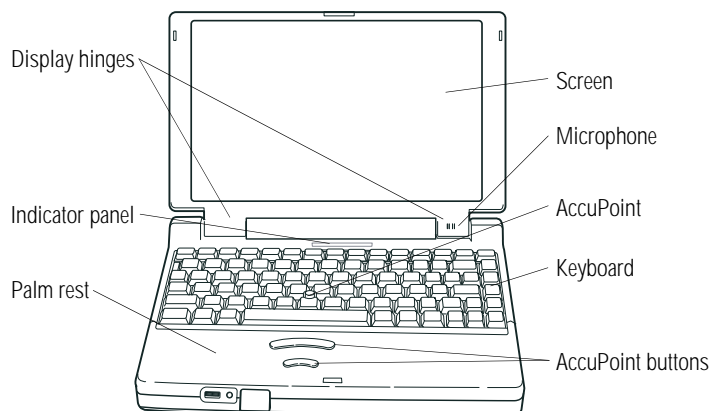

The front with the display open

The computer's **screen** is a liquid crystal display (LCD) that provides clear, sharp images.

The **display hinges** attach the display panel to the computer.

The built-in **microphone** lets you record sounds.

The 82-key **keyboard** provides all the functionality of a full-sized 101-key keyboard. For more information, see “How to Use the Keyboard” on page 81.

The **AccuPoint** pointing device combines the function of a mouse with the convenience of never having to remove your hands from the keyboard. For more information, see “Using the AccuPoint Pointing Device” on page 28.

The front panel provides a **palm rest**.

The **AccuPoint buttons** work with the AccuPoint. The larger (primary) button acts as the left button on a mouse. The smaller (secondary) button acts as the right mouse button. For more information, see “Using the AccuPoint Pointing Device” on page 28.

The lights on the **indicator panel** provide information about various system functions. The next section discusses the indicator panel lights.

The Indicator Panel

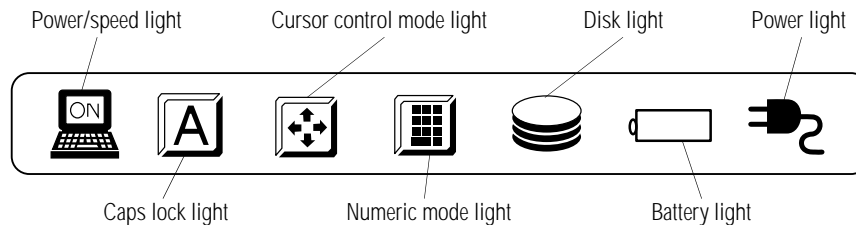

The indicator panel



The **power/speed light** glows when the computer is on and shows the speed at which the computer is processing information. Green indicates high speed and orange indicates low speed.



The **caps lock light** glows when you press the Caps Lock key. When this light is on, pressing a letter key on the keyboard produces an upper-case (capital) letter. For more information, see “The Character Keys” on page 82.



The **cursor control mode light** glows when the cursor control overlay is on. When the overlay is on, pressing an overlay key moves the cursor as shown by the white legend printed on the left front of the key instead of the letter printed on the top of the key. For more information, see “The Cursor Control Overlay” on page 250.



The **numeric mode light** glows when the numeric overlay is on. When the overlay is on, pressing an overlay key displays the white number printed on the right front of the key instead of the letter printed on the top of the key. For more information, see “Typing Numbers” on page 83.



The **disk light** glows when a drive—hard disk, diskette drive, or CD-ROM drive—is currently in use.



CAUTION

Do not turn the computer off if this light is on. Doing so may damage the computer, the drive or both.



The **battery light** indicates the status of the battery charge. For more information, see “Monitoring Battery Power” on page 124.



The **power light** glows when the computer is connected to an external power source. For more information, see “Connect to a Power Source” on page 15.

Let's Start at the Very Beginning

Now that you know where everything is, it's time to get to work. This chapter provides easy-to-follow steps for getting the computer up and running.

Connect to a Power Source

Connecting the computer to a power source provides power to run the computer and charge the battery. Since the Satellite 200 Series computer has a built-in battery and AC adapter, all you require is a power cord. Just plug the cord into the computer and an AC outlet.

Before you can use the battery to power the computer, you must charge it. Leave the computer plugged in for at least two and a half hours with the computer turned off or five to eight hours with the power on. Then the battery will be completely charged and ready to power the computer.



NOTE

Once the battery is charged, don't leave the computer plugged in and turned off for more than a few hours at a time. Because overcharging shortens battery life, we recommend you use a charger/conditioner, such as Noteworthy's battery charger.

To connect your computer to a power source, follow these steps:

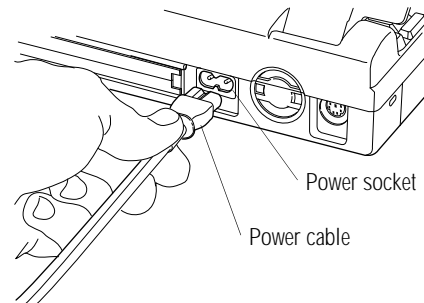

Connecting the power cable to the computer

- 1 Connect the power cable to the power socket on the back of the computer.**
- 2 Connect the other end of the power cable to an AC wall outlet.**

The power light on the indicator panel glows green.

Adding Memory (Optional)

Your computer comes with enough memory to run most of today's popular applications. However, you may want to increase the computer's memory. With additional memory, the computer:

- ❖ can run more programs and open more documents at the same time.
- ❖ runs Windows 95 and Windows applications faster.

By installing extra memory now, you'll be able to operate your computer at its maximum capacity from the start. Of course, you can always come back to this section if you decide to add memory at a later time.

Sizes of Memory Modules

Additional memory is easy to install. Memory modules, available from your dealer, come in the following sizes:

| <i>Memory Module Size</i> | <i>Total Memory in System</i> |
|---------------------------|-------------------------------|
| No module installed | 8 MB |
| 8 MB | 16 MB |
| 16 MB | 24 MB |
| 32 MB | 40 MB |

Install the Memory Module

The memory module installs into the memory expansion slot on the bottom of the computer. You'll need a Phillips screwdriver for this procedure.

1 Click Start, then click Shut Down.

Make sure Resume Mode is turned off before you shut down the computer. If you've never used the computer or Resume Mode, you don't need to do anything else. If you've turned Resume Mode on, refer to "Starting Again Where You Left Off" on page 133 for instructions on turning it off.

2 Click the button next to Shut down the computer, then click Yes.

Windows 95 shuts down and turns the computer off automatically.

3 Unplug the computer.



WARNING

Do not install a memory card while the computer's power is on. This may damage the computer, the card or both.

4 Close the display and remove any cables you may have connected.

If you're installing additional memory before using the computer, you haven't connected any cables yet.

5 Turn the computer upside down.

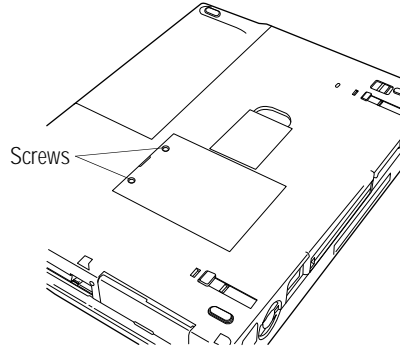

The memory slot cover

6 Use a small Phillips screwdriver to remove the two screws that secure the memory slot cover.

7 Remove the memory slot cover.



Static electricity can damage the memory module. Before you handle the module, touch a grounded metal surface to discharge any static electricity you may have built up.

To avoid damaging the memory module, be careful not to touch its pin connector (on the side you insert into the computer).

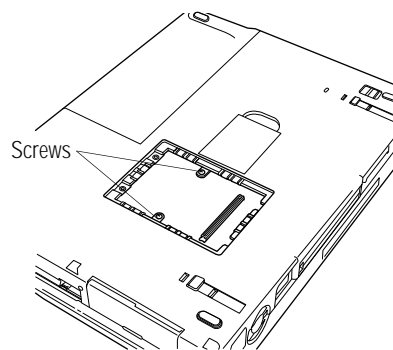

Removing the screws

8 Remove the two screws from the memory slot.

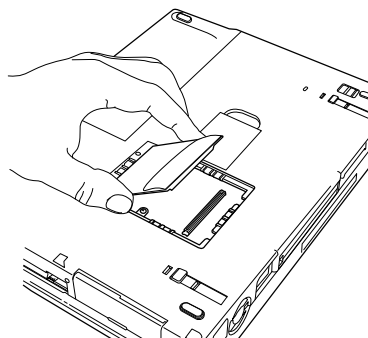

Inserting the memory module

9 Carefully place the module in the slot. Line up the connector on the module directly above the connector in the computer.

10 Gently press the module down onto the slot's connector.

Do not force the module into position.

11 Secure the module in place with the two screws you removed in step 8.

12 Replace the memory slot cover.

13 Replace the slot cover screws you removed in step 6 and tighten them.

14 Turn the computer over.

When you turn your computer on, it recognizes the additional memory automatically.

Removing a Memory Module

If you ever need to remove the memory module:

- 1 Follow steps 1 through 6 in the previous section to open the memory slot and remove the screws that secure the card.**

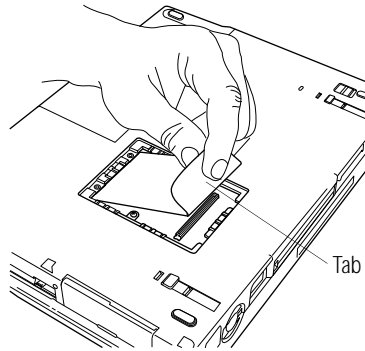

Removing the memory module

- 2 Lift up the memory card tab to remove the card.**

If your memory card doesn't have a tab, lift straight up on the edge of the card closest to the back of the computer.

- 3 Replace the screws that held the card in place.**
- 4 Follow steps 12 through 14 in the previous section to close and secure the memory slot.**

Connecting the External Diskette Drive

The computer's 3.5-inch diskette drive is useful for installing software on the hard disk, exchanging information with other systems, and making backup copies of the files stored on the hard disk.

Your computer uses an external diskette drive mounted in an external chassis. This section describes the external drive and how to connect it.

If you prefer, you can remove the CD-ROM drive and install the diskette drive into the SelectBay. See "Swapping Drives in the SelectBay" on page 104 for more information.



The external chassis works with the diskette drive only. The CD-ROM drive only works when installed in the computer's SelectBay.

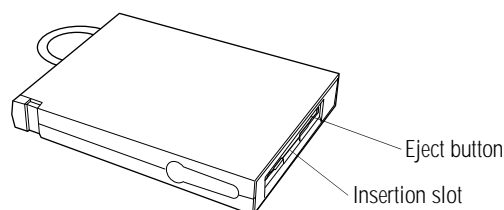

The external diskette drive

A protective flap inside the disk **insertion slot** automatically retracts when you insert a diskette. Push the disk **eject button** to remove a diskette from the drive.

Attaching the External Diskette Drive

To attach the external diskette drive to the computer, follow these steps:

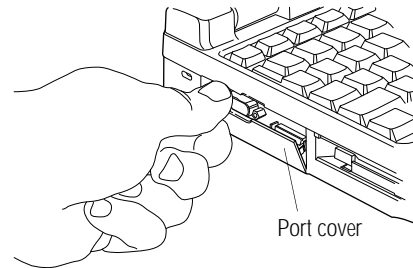

Opening the port cover

1 **Open the port cover on the left side of the computer.**

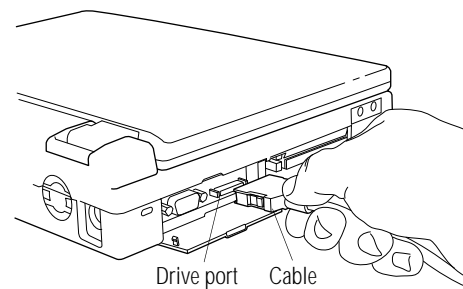

Attaching the external diskette drive

2 **Attach the cable from the external diskette drive to the computer's external diskette drive port.**



You may attach the external diskette drive with the computer on or off. If you attempt to use the diskette drive and it is not attached to the computer, the computer displays an error message.

The computer automatically recognizes the external diskette drive and calls it the A drive.

Disconnecting the External Diskette Drive

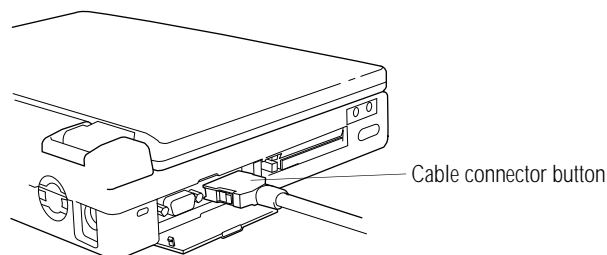

Disconnecting the external diskette drive

To detach the external diskette drive from the computer, press the **cable connector buttons** (on each side of the cable connector) and gently pull the connector out of the **external diskette drive port**.



NOTE

If you try to access a diskette in the external diskette drive after disconnecting the drive, you will get a disk error message.

Inserting and Removing Diskettes

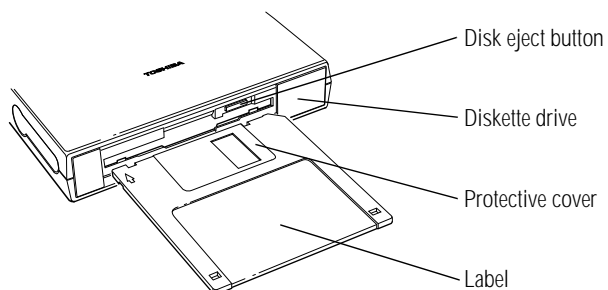

Inserting a diskette

A protective flap inside the disk insertion slot automatically retracts when you insert a diskette.

The previous illustration shows the correct insertion procedure. Make sure your fingers are touching the **label** and that the **protective cover** points toward the **diskette drive**. When the diskette is almost completely in the drive, you will feel a slight resistance. Push the diskette gently into place. When the diskette is securely in the drive, the **disk eject button** pops out.

Push the **disk eject button** to remove a diskette from the drive.

Connecting a Parallel Printer

If you've already purchased a printer, now is a great time to connect it to the computer. If you don't have or don't wish to connect a printer yet, don't worry. You can always connect one later.

The most common type of printer is a parallel printer. To connect a parallel printer, you'll need a standard parallel printer cable. You may have received a cable when you purchased your printer. Otherwise, printer cables are available from your dealer and at most computer and electronics stores.



NOTE

If your printer is ECP- or IEEE-compliant, make sure your printer cable is an IEEE 1284 cable.

To connect the printer to the computer, follow these steps:

1 Make sure the computer is off.



WARNING

Don't connect the printer cable if the computer's power is on. Doing so may cause damage to the printer, the computer or both.

2 Identify the two ends of the printer cable.

One end (with the male DB-25 connector) connects to the computer. The other end connects to the printer.



Identifying the ends of the printer cable

3 With the printer off, connect the printer cable to your printer.

If you're unsure how to do this, your printer's documentation will tell you.

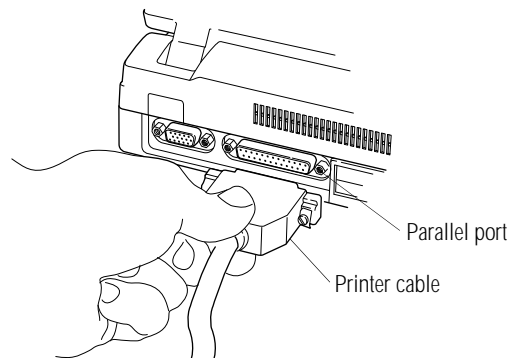

Connecting the printer cable to the parallel port

4 Connect the printer cable to the computer's parallel port.



Don't connect the printer cable if the computer's power is on. Doing so may cause damage to the printer, the computer or both.

5 Plug the printer's power cable into an AC outlet.

Open the Display

The final step before you turn your computer on is to open the display.

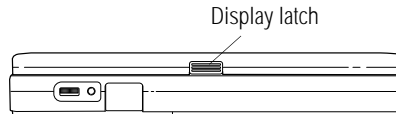

The display latch

- 1 Facing the front of the computer, locate the latch on the front center of the display panel.**

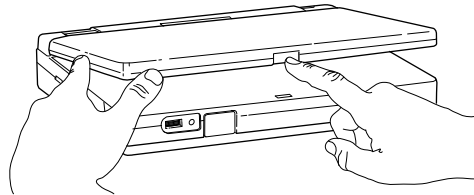

Opening the display

- 2 Push on the latch and lift the display panel.**
- 3 Adjust the display panel to a comfortable viewing angle.**



To avoid damaging the display panel, do not force the panel beyond where it moves easily and never lift the computer by the display panel.

Fill In Your Registration Card and Mail It

Take a few minutes now to fill in and mail your product registration card. The card was on the keyboard of your computer when you first opened the display panel. Sending in your product registration card lets Toshiba keep you up to date with information about new products and upgrades.

Registering your computer also extends your Toshiba warranty world-wide at no charge to you. See the registration card and warranty information for details about the warranty options available from Toshiba.

Turn the Computer On

Finally, the preparation is over. It's time to turn the computer on and get to work. To turn the computer on, follow these steps:

- 1 **Make sure there's no diskette in the diskette drive.**
- 2 **If you have a printer connected to your computer, turn the printer on and wait until the printer is ready (on line).**
- 3 **Locate the power/speed light on the indicator panel.**

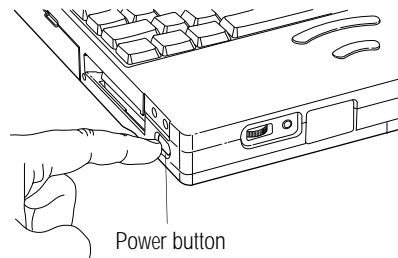

Turning the power on

- 4 **Press and hold the power button on the left side of the computer until the power/speed light turns on.**



When you turn the computer for the first time, do not turn the power off again until the operating system has loaded completely.

Using the AccuPoint Pointing Device

The computer's AccuPoint pointing device enables you to move the cursor and to select items on the screen. If you're familiar with desktop computers, you may have used a mouse or trackball for this purpose. The AccuPoint provides all the functionality of a mouse or trackball without your hands ever leaving the keyboard.

If you would rather use a mouse or trackball, you can connect one to the computer's serial port or PS/2 port. You may also use the mouse port on the optional NoteDock™.

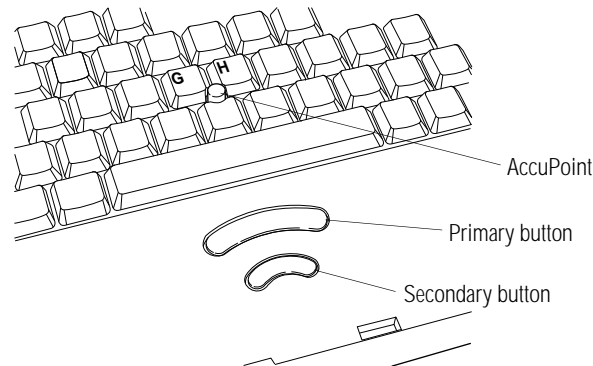

The AccuPoint pointing device

To move the cursor, gently push the **AccuPoint** in the direction you want the cursor to move. Pushing harder on the AccuPoint moves the cursor faster.

When a step instructs you to click or choose an item, move the cursor to the item, then press and release the **primary button**. To double-click, click the primary button twice in rapid succession. The primary button corresponds to the left button on a mouse.

The function of the **secondary button** depends on the programs you're using. It corresponds to the right button on a mouse. Check your programs' documentation to find whether they use the right mouse button.

When You Turn the Computer on the First Time

The first time you turn the computer on, it displays several messages and leads you through four welcome screens. Read each welcome screen carefully, then press Enter. These screens explain the procedures for creating master program diskettes. If you purchased the Satellite 200CDS, you also have the option of selecting Windows 95 or Windows for Workgroups as your operating system. Windows 95 is preinstalled on the Satellite 205CDS.

After you read the welcome screens, the system displays the Welcome to Windows 95 Setup screen. Complete the following steps to set up your system:



If you plan to choose Windows for Workgroups, be aware that you'll need to complete about eight Windows 95 Setup screens before the setup program gives you the opportunity to choose your operating system. Read each screen carefully to avoid installing Windows 95 accidentally.

- 1 In the Welcome to Windows 95 Setup screen, click Next. (Use the AccuPoint to position the pointer over the Next button, then press the primary button.)**

Setup displays the Regional Settings screen.

- 2 Select your Regional Settings and click Next. The default is English (American).**

Setup displays Keyboard Layout screen.

- 3 Select the keyboard layout and click Next. The default is United States.**

Setup displays the User Information screen.

- 4 Type your name and company in the appropriate fields, then click Next.**

Setup displays the License of Windows 95 screen.

5 Read the license information, then click Next.

Setup displays the License Agreement screen.

6 Read the license agreement. If you agree to the terms, click the button next to “I accept the agreement” to continue the set up process.**7 Click Next.**

Setup displays the Certificate of Authenticity screen.

8 Type in the number from the Certificate of Authenticity, affixed to the Windows 95 manual that came with your computer, then click Next.

Setup displays the Windows Version screen.

9 Choose your operating system:

If you have a Satellite 200CDS, carefully consider your choice of operating system. Once you choose Windows 95 or Windows for Workgroups, the setup program automatically (and permanently) deletes the operating system you did not select from your system.

- ❖ To choose Windows 95 (the default), click Next.
- ❖ To choose Windows for Workgroups, click Change. Setup displays the Operating System Choice screen. Click “No, I want to install MS-DOS 6.22 and Microsoft Windows for Workgroups 3.1,” then click OK.

Setup displays a Windows 95 Setup Wizard screen (even if you chose Windows for Workgroups) and installs the devices it found on your system.



This screen displays the message “Please wait while Setup prepares your Windows 95 computer” whether you chose Windows 95 or not. If you chose Windows for Workgroups and still see this message, don't be alarmed.

Setup displays the Finishing Setup screen, prompting you to restart your computer.

10 Click Finish to restart the computer.

The computer restarts and loads the operating system you selected.

If you chose Windows for Workgroups, follow the instructions in the following section, “Finish the Windows for Workgroups Setup Procedure” to complete the setup procedure.

If you chose Windows 95, follow the instructions in “Finish the Windows 95 Setup Procedure” on page 32 to complete the setup procedure.

Finish the Windows for Workgroups Setup Procedure

After the computer restarts and loads Windows for Workgroups, the system displays a Windows Setup screen, prompting you for your name, company, and product number:

1 Type your name and company in the appropriate fields. You may leave the product number field blank, or type in the Windows 95 Certificate of Authenticity number.

2 Click Continue.

Setup prompts you to verify the information you just entered.

3 If the information is correct, click Continue.

To change any of the information displayed, click Change.

Setup displays the Printer Installation screen.

4 If you have a printer, use the ↑ and ↓ keys to select your printer from the list and click Install.

If you don't have a printer, choose No Printer from the list and click Install.

The computer restarts, loads Windows for Workgroups, and displays the Windows Program Manager screen.

How to Use this Guide with Windows for Workgroups

The instructions in this guide are specific to Windows 95. If you chose Windows for Workgroups, a number of things will be different, including:

- ❖ The tutorial provided in “Getting to Know Windows 95” on page 51 refers to Windows 95 only.
- ❖ The instructions in this manual for starting MaxTime[®], Hardware Setup, and Fn-esse[™] are for Windows 95 only. In Windows for Workgroups, start these programs by double-clicking their icons in the Toshiba Utilities group in Program Manager. Once started, these programs function in Windows for Workgroups much the same as they do in Windows 95.
- ❖ Windows for Workgroups does not include a Suspend command. Use Resume Mode instead.
- ❖ Windows 95 contains the files your computer needs to communicate with optional PCMCIA-compatible PC Cards. Both Windows 95 and Windows for Workgroups have CardWizard for configuring optional PC Cards.
- ❖ The steps in “Changing the Display Mode” on page 257 are for Windows 95. To change the display mode in Windows for Workgroups, double-click the Chips CPL icon in the Control Panel.

For more information on using Windows for Workgroups, refer to “Using Windows for Workgroups” on page 397.

Finish the Windows 95 Setup Procedure

After the computer restarts and loads Windows 95, the system configures your system, displays several messages, then starts the Add Printer Wizard.

Set Up Windows 95 to Work With Your Printer

If you already have a printer, click Next when the system prompts you to set up your printer. If you plan to purchase a printer later,

click Cancel now and see “Setting Up Windows 95 to Work with Your Printer” on page 87 when you’re ready to connect it.

To set up Windows 95 to work with your printer now, follow these steps:

- 1 When Windows 95 opens the Printers dialog box, scroll through the lists of manufacturers and printers until you find yours.**

If your printer is not listed, it probably came with its own diskette. Insert this diskette into the diskette drive and click Have Disk. When Windows 95 displays the Install From Disk dialog box, click OK.

- 2 Select your printer and click Next.**
- 3 Set the port to LPT1: for a parallel printer (or COM1: for a serial printer) and click Next.**
- 4 Type in a new name for your printer or accept the default and click Next.**
- 5 If your printer is connected and turned on, click Finish to print a test page.**

To finish the setup procedure without printing a test page, click No, then Finish.

Select Date/Time Properties

As Setup continues, Windows 95 displays the Date/Time Properties dialog box. This dialog box has two tabs. Click on a tab to bring it to the front.

- 1 On the Time Zone tab, select your time zone by clicking the up and down arrow keys.**
- 2 On the Date and Time tab, set the correct date and time, if necessary.**
- 3 When you’re done, click Close.**

Create Windows 95 Diskettes

The Microsoft Create System Disks program creates program diskettes for the Windows 95 operating system. To run this program, click Next when prompted during the initial startup procedure.

If you don't want to take the time to make these diskettes now, click Cancel. When you're ready to make the diskettes, refer to "Running Microsoft Create System Disks" on page 36.



You must create your own set of Windows 95 diskettes. If your hard disk ever fails, you'll need the diskettes to reinstall Windows 95 on your system. If this occurs and you haven't made these diskettes, you will have to buy a new copy of Windows 95.

Complete the Initial Startup Procedure

Windows 95 completes its setup procedure and displays the Welcome to Windows 95 screen. This screen provides the following options:

- ❖ The Windows 95 Tour gives you a brief overview of Windows 95. For a more complete introduction, see "Getting to Know Windows 95" on page 51.
- ❖ Select What's New for answers to common questions about Windows 95.
- ❖ Online Registration lets you register Windows 95 with Microsoft®.

Once you've finished looking at any or all of the above options, click Close to finish the initial startup procedure and open Windows 95.

Create Master Diskettes or Purchase the CD-ROM

When you buy a program at a computer store, you receive a set of program diskettes or a CD-ROM containing the files necessary to install the program on your computer's hard disk. You can also use them to reinstall your software if necessary.

However, your computer comes with Windows 95 (or if you purchased the Satellite 200CDS, you could chose Windows for Workgroups) and a number of other programs already installed on the hard disk. If any of these programs is ever damaged or deleted, you'll need program diskettes to reinstall it.

You must buy blank diskettes and run Microsoft's Create System Disks program to make a set of Windows 95 diskettes.

There are two ways to obtain program diskettes for your other pre-installed software (excluding Windows 95 and any other Microsoft applications):

- ❖ Buy blank diskettes and run Toshiba's Master Disk Creator program.
- ❖ Purchase the Toshiba drivers and utilities on CD-ROM from Toshiba, using the order form that came with your computer.



NOTE

If you chose Windows for Workgroups, use Master Disk Creator to make its program diskettes.

Preparing to Create Master Diskettes

Disk image files on your hard disk contain all the information to create program diskettes for the factory pre-installed programs on your computer. Microsoft Create System Disks and Master Disk Creator copy these disk images to the diskettes.



You cannot reinstall programs from the disk image files on the hard disk. You must use program diskettes created with Create System Disks to reinstall Windows 95, and either the diskettes created with Master Disk Creator or the CD-ROM you purchased from Toshiba to reinstall other pre-installed programs.

To run these programs, you need:

- ❖ About 4 hours.
- ❖ Approximately 62 blank, 3.5-inch, high-density (1.44 MB) diskettes. This includes approximately 30 for Windows 95 and up to 32 for Master Disk Creator. These diskettes must be write-enabled (the write-protect tab at the left corner of the diskette must cover the square hole).

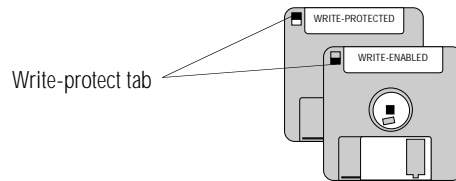

Write-protected and write-enabled diskettes

Although you can run these programs at any time, it's a good idea to create your program diskettes the first time you start the computer. This way you won't risk accidentally deleting a program file and have no master diskettes available from which to reinstall it.

Running Microsoft Create System Disks

If you chose not to create Windows 95 diskettes when you turned the computer on the first time, you should do so now. Since Microsoft Create System Disks requires you to make all the Microsoft Windows 95 diskettes at one time, you need to have at least 32 new, formatted high-density diskettes available before you start the program. Label the diskettes using the pre-printed

Microsoft Windows 95 diskette labels provided with your computer.



You can run only Create System Disks one time. Make sure you don't lose your Windows 95 diskettes once you've created them.

To run Create System Disks, follow these steps:

1 Make sure the diskette drive is connected to the computer.

If you're unsure how to do this, see "Connecting the External Diskette Drive" on page 21.

You may also swap the CD-ROM and diskette drive, according to the instructions in "Swapping Drives in the SelectBay" on page 104.

2 Click Start, then point to Programs.

3 Point to Accessories, then point to System Tools.

4 Click Create System Disks.

Windows 95 opens the Create System Disks program. Follow the instructions on the screen to create the program diskettes.

Running Master Disk Creator

Master Disk Creator creates program diskettes for the rest of the programs pre-installed on your computer (if you decide not to buy the CD-ROM). It is a very simple program to use. You'll need up to 40 high-density diskettes to hold a complete set of program files (more if you are using Windows for Workgroups). Label the diskettes as indicated by Master Disk Creator.

To run Master Disk Creator, follow these steps:

1 Make sure the diskette drive is connected to the computer.

If you're unsure how to do this, see "Connecting the External Diskette Drive" on page 21.

You may also swap the CD-ROM and diskette drive, according to the instructions in “Swapping Drives in the SelectBay” on page 104.

2 Click Start, then point to Programs.

3 Point to Toshiba Utilities, then click Master Disk Creator.

Master Disk Creator displays a welcome screen.

4 Choose OK by using the AccuPoint to move the pointer to it and clicking with the primary button.

Master Disk Creator displays a list of the available disk images similar to the following example.

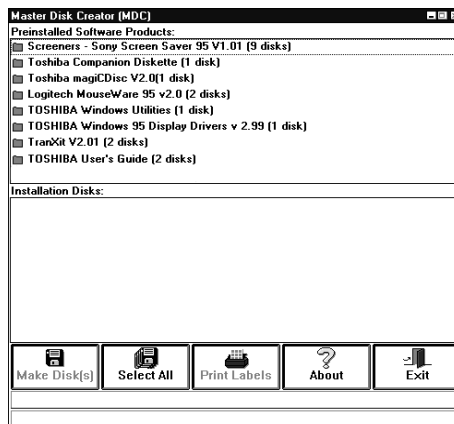

A sample list of disk images

5 To create a complete set of program diskettes, choose Select All.

If you don't want to create a complete set of diskettes now, choose only those programs for which you want to create diskettes.

6 Choose Make Disks.

Master Disk Creator displays the MDC Disk Creation Confirmation screen.

7 Label the diskettes with the names shown on the screen.

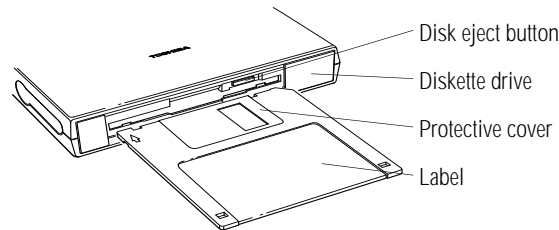

Inserting a diskette

- 8 Insert the appropriately labeled blank formatted diskette into the diskette drive.**
- 9 In the MDC Disk Creation Confirmation screen, choose a Write method and click Create Disk.**

Master Disk Creator begins copying files to the diskette and displays a meter monitoring the copying process.

- 10 When Master Disk Creator prompts you to, press the disk eject button to remove the diskette.**



If the diskette drive light is on, do not remove a diskette. Doing so could destroy the information on the diskette and damage the diskette and/or the drive.

- 11 Write-protect the diskette by moving the tab on the back of the diskette to expose the write-protect hole.**

Write-protecting a diskette prevents you from erasing or overwriting the information on the diskette.

- 12 Continue inserting and removing diskettes according to the instructions on the screen.**

Since creating program diskettes will take some time, now is a good time to fill in your registration card if you haven't yet done so. It also gives you time to skim through the remainder of this manual and fill in the reader response card. Toshiba welcomes your comments and suggestions for improving the quality of the documentation.

13 When you've finished making the master diskettes, store them together in a safe place.

Make sure you keep the diskettes away from extreme temperatures and humidity and strong magnetic fields, such as those generated by large stereo speakers.

Using The Electronic Guide

Your Satellite 200 Series computer comes with this guide in electronic form on your hard disk. The best thing about electronic books is that they are stored on the computer so you don't have to take the printed documentation with you when you travel.

The electronic *User's Guide* is a copy of this printed book. This chapter explains how to use the electronic version of the guide.

Opening the Book

To open the book, follow these steps:

- 1 Click Start, then point to Programs.**
- 2 Point to Toshiba Utilities, then click User's Guide.**

Windows 95 opens the guide.

The Parts of the Window

The electronic book opens at the title page.

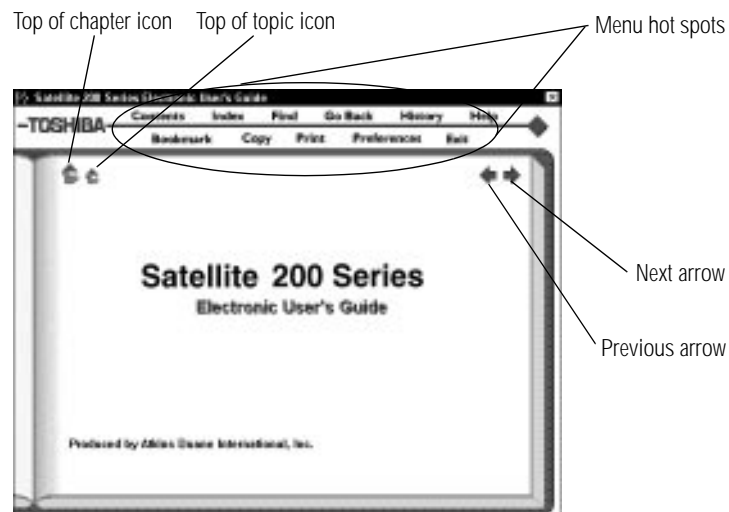

The title page

The **menu hot spots** above the book provide these options.

- ❖ **Contents** displays the table of contents for the entire book.
- ❖ **Index** displays the index you normally find at the back of the book.
- ❖ **Find** lets you input a term and search for it in the book.
- ❖ **Go Back** retraces your steps through the book.
- ❖ **History** shows a list of all the places you have been.
- ❖ **Help** explains how to use the book's features.
- ❖ **Bookmark** marks a topic so you can return to it in the future.
- ❖ **Copy** copies selected text to the clipboard.
- ❖ **Print** prints the current topic.
- ❖ **Preferences** lets you customize the books features.
- ❖ **Exit** closes the book.

Clicking the **Top of chapter icon** returns you to the beginning of the current chapter or topic.

Clicking the **Top of topic icon** returns you to the beginning of the current topic.

The **previous** and **next** arrows allow you to move forward or backward from topic to topic.

Finding a Topic Quickly

As in a printed book, to find a particular topic you can either search the index or use the table of contents.

In addition to providing an index and table of contents, the electronic *User's Guide* maintains a list of all the words in the book. If the index and table of contents do not contain the word you're looking for, try the Find option. You can search the current topic or the entire *User's Guide*. Follow these steps:

1 Click Find.

The book displays a box for you to enter the word or phrase.

2 Enter the word or phrase and press Enter or click Search.

Find displays a list of all the sections that contain this term.

3 Select the section you wish to read and press Enter.

Find displays the section.

Reading a Topic

If the topic contains more text than will fit on the screen, use the scroll bar to read the additional text.

When you get to the end of the topic, click the next arrow to go to the next topic or the previous arrow to go to the previous topic. Clicking the next arrow takes you through the electronic book in the same sequence as the printed book.

Cross-References

The topic you located using the Index, Contents or Find may still not be the one you are looking for, but as you read the text a cross-reference may point you to the section you need.

Cross-references are shown in green underlined text. To view a cross-reference, follow these steps:

1 Position the pointer over the cross-reference.

The pointer changes to a pointing hand symbol.

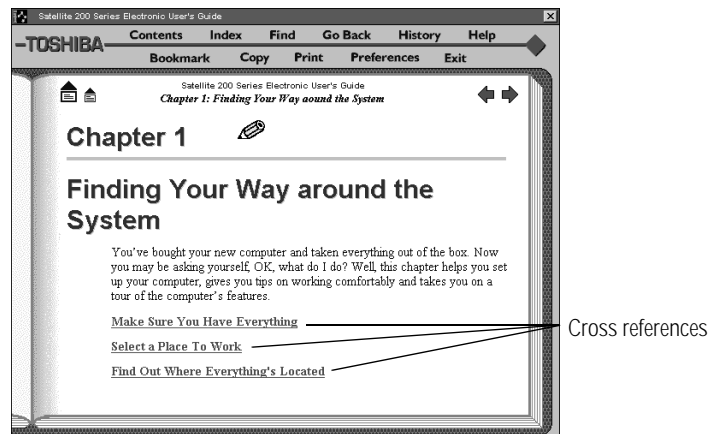

Using a cross reference

2 Click the cross-reference.

The program displays the section that contains the information relating to the cross-reference you selected.

When you have finished reading the cross-referenced material, click Go Back to return you to the original topic.

Using Bookmarks

Creating a bookmark allows you to mark a portion of the text that you want to be able to find quickly in the future.

Creating a New Bookmark

To create (or define) a bookmark, follow these steps:

- 1 Position the pointer at the beginning of the text you want to find again.**
- 2 Click the Bookmark hot spot.**

| | | | | |
|------------------------------|------------|--------------|------------|---|
| Add a bookmark (enter name): | | | | X |
| Entry Up | Entry Down | Remove Entry | Clear List | |

The bookmark dialog box

- 3 Enter a name for the bookmark.**

This can be any name you choose.

- 4 Press Enter or click the X in the upper right corner of the box.**

The program places a bookmark at the bottom of the window.

Viewing the Topic Marked by a Bookmark

To view a marked topic, click its bookmark. Moving the pointer over the bookmark displays the name you assigned.

Another way to locate the topic you marked is through the bookmark list. Follow these steps:

- 1 Click the Bookmark hot spot**
- 2 Select the bookmark name you wish to find.**
- 3 Click the box above the list to go to the topic.**

Deleting a Bookmark

To delete a previously defined bookmark, follow these steps:

- 1 Enter the name of the bookmark or locate it in the torpedoing list box.**
- 2 Click Remove Entry.**

The program deletes the bookmark.

Keeping Track of Where You've Been

An electronic book can keep track of what you've already read. If you wish you could go back to the page you read five minutes ago, but you don't remember where you were, follow these steps:

1 Click History.

The program displays a list of all the topics you've viewed in this session.



A history list

2 Click the topic's title.

3 Click the top box and you're back where you were before.

You can delete topics from this list or clear the list entirely by clicking the appropriate boxes.

Getting Help

The electronic guide comes with its own help text. If you are not sure about a feature, click Help.

Help is context-sensitive. If you keep the Help window open, the Help text changes to describe the current feature you are pointing at with your pointer.

Using Material from the Book

Although this book is copyrighted, you may select text and copy it to the clipboard for use in your own projects. You may also print individual topics or selected text.

Copying a Selection

To copy a selection, follow these steps:

- 1 **Click Copy.**

The book displays the Copy dialog box.

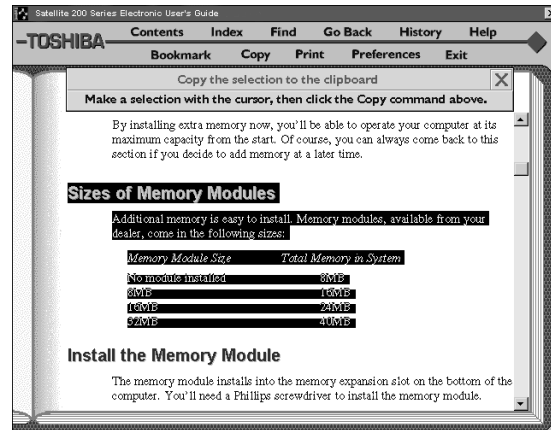

Selected text ready to copy

- 2 **Select the text to copy.**

- 3 **Click “Copy the selection to the clipboard.”**

You can insert this text into another document.

Printing a Selection or Topic

Follow these steps to print:

- 1 **Click the Print hot spot.**

- 2 **Select the text you wish to print.**

Do not select any text if you wish to print the entire topic.





3 Click “Print a Selection” to print the text you selected.

Click “Print the Current Topic” to print the whole topic.

The program prints to the current printer. Before you click Print, make sure the printer’s is on line (ready) and the printer has paper.

Changing How the Book Works

The Preferences hot spot lets you customize the electronic book’s features to meet your preferences.

| Click below to change preferences: | | X |
|------------------------------------|---|---|
| Audible Alerts |  | |
| Bookmark Icons |  | |
| Checkpoints |  | |
| Top Icons |  | |
| Text Size | 2 | |
| Match Color for Find |  | |

The preferences dialog box

Audible Alerts sound for various functions. To turn these off click the Audible Alerts option.

If you would rather not see the **Bookmark Icons**, click here to turn them off. If bookmark icons are off, click Bookmark to view a list of the bookmarks.

Checkpoints are dialog boxes that appear when you are about to do something you may not wish to do.

You can control the size of the text in the book window by clicking the **Text Size** option.

The **Match Color for Find** option changes the color the book uses to highlight the text you are searching for.

Reinstalling the Electronic User’s Guide

If for any reason you need to restore this book to the hard drive, you must use the master program diskette that contains the book files. For more information about master program diskettes, see “Create Master Diskettes or Purchase the CD-ROM” on page 35.

Follow these steps to reinstall online documentation:

- 1 If the CD-ROM drive is in the SelectBay, replace it with the internal diskette driver or connect the external diskette drive.**

To exchange drives in the SelectBay, see “Swapping Drives in the SelectBay” on page 103.

- 2 Insert the master program disk that contains the book.**
- 3 Click Start, then click Run.**

Windows 95 displays the Run dialog box.

- 4 In the Run dialog box, type the command line `a:\install` and click OK.**

Always install the book into the C:\DOCS folder.

- 5 When the installation is complete, eject the diskette from the drive.**

Getting to Know Windows 95

Windows 95 is the computer's operating system, providing a means of communication between your computer, your programs and you. This chapter introduces Windows 95 by taking you through a few basic tasks.

If you've never used Windows before, the skill and confidence you'll gain will more than offset the small amount of time you will spend going through these lessons.

If you've used an earlier version of Windows, you'll notice that Windows 95 is very different. Windows 95 Help discusses a number of the major differences in an easy question-and-answer format. Click Start, then Help to open Help, click the Index tab, then type tips and double-click "for Windows for Workgroups users."

One of the wonderful things about Windows 95 is its flexibility. While the steps in this chapter will accomplish the indicated tasks, there are often other ways of doing things. For example, if you've used earlier versions of Windows, many familiar key combinations will still work. If you're curious, refer to on-line help or your Windows 95 documentation for more information.

Lesson 1: Exploring the Desktop

The desktop is the launching pad for everything you can do in Windows 95. You use its features to start programs, find documents, set up system components and most other computing tasks.

The following illustration identifies the major features of the desktop:

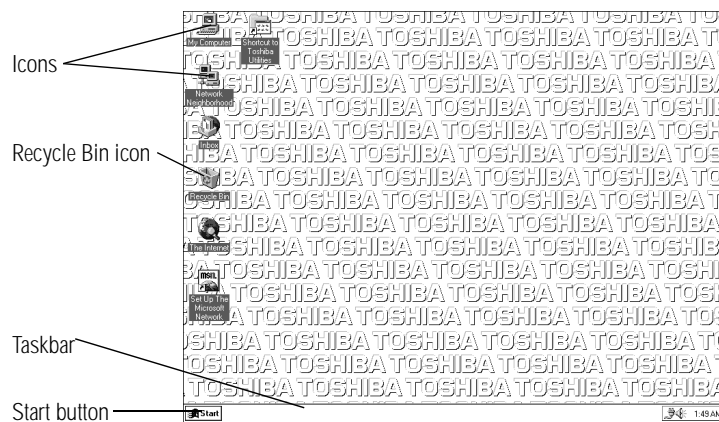

The desktop

The **Start button** does just what it says. You can use it to start programs and open documents, files and folders within Windows 95 (see “Lesson 5: Starting Programs” on page 58).

The **taskbar** lets you know what documents you currently have open. It may also display the time. Right now, the taskbar is blank because you haven’t started anything. As you work through the lessons in this chapter, the taskbar will change to reflect what you’re doing.

The **icons** provide shortcuts to programs, documents, files, folders, system features and components. To learn how to create and use these icons, refer to your Windows 95 documentation.

One special icon is the **Recycle Bin**. You use the Recycle Bin to delete files and remove objects from the desktop. You’ll learn more about the Recycle Bin in “Lesson 11: Removing Objects from the Desktop” on page 67.

Lesson 2: Using the AccuPoint Pointing Device

The AccuPoint is your basic tool for moving around and working in Windows 95. This lesson teaches you some of the things you can do with the AccuPoint.

Follow these steps:

1 Push gently against the left side of the AccuPoint.

Notice how the arrow (pointer) moves to the right edge of the desktop.

2 Push a bit harder against the right side of the AccuPoint.

Notice that the pointer moves faster as you increase the pressure on the AccuPoint.

3 Practice moving around the screen.

Experiment by moving in different directions and at different speeds.

4 Move the pointer to the Start button and click the primary button (it's the larger one).

Windows 95 opens the Start menu.

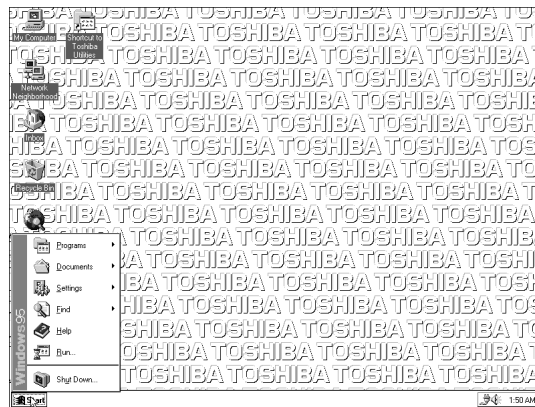

The desktop with the Start menu open

5 Click an empty area of the desktop to close the Start menu.

- 6 With the pointer in an empty area of the desktop, click the secondary button (the smaller one).**



Throughout the remainder of this guide, the term “click” refers to clicking the primary button. Instructions requiring the secondary button specifically mention that button. For example, “click the secondary button.”

Windows 95 opens the desktop shortcut menu.



The desktop shortcut menu

- 7 Click an empty area to close the shortcut menu.**
- 8 Move the pointer to the My Computer icon and click the primary button twice rapidly.**

This process is known as “double-clicking.”

The My Computer window opens.

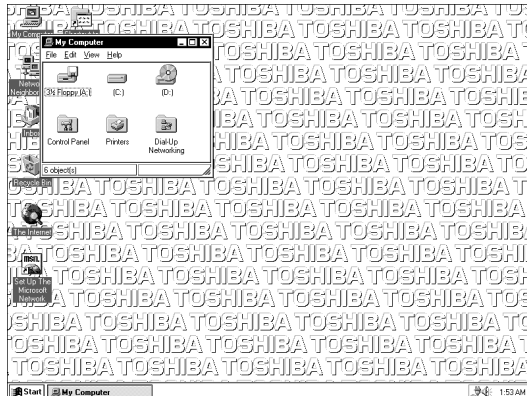

The desktop with the My Computer window open

- 9 Click the taskbar at the bottom of the screen and, while holding the primary button, drag the pointer to the right edge of the desktop, then release the primary button.

This process is known as “clicking and dragging.”

The taskbar moves from the bottom to the right edge of the desktop.

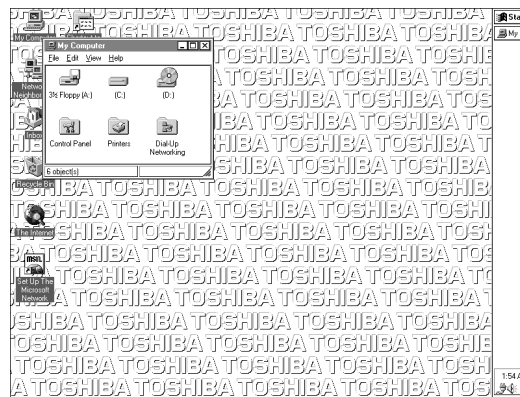

The desktop with the taskbar on the right

You may move the taskbar to any of the desktop’s four edges.

- 10 Click the taskbar once again and drag it back to the bottom of the desktop.

Lesson 3: Creating a New Document

Now that you’re used to the desktop, you’ll want to go on to do some real work.

With earlier versions of Windows, you had to start a program before you could create a document. Windows 95 lets you choose a type of file and then opens a program appropriate to that file type.

This lesson teaches you how to create a text file without first opening a program.

Follow these steps:

- 1 Move the pointer to an empty area of the desktop and click the secondary button.**

Windows 95 displays a shortcut menu of commands applicable to the desktop.

- 2 Point to New, then click Text Document.**

Windows 95 creates an icon on the desktop called New Text Document.txt with the icon name highlighted.

- 3 You'll probably want to give your file a meaningful name, so type My New File and press Enter.**

- 4 Double-click the icon.**

Windows 95 opens the new file in Notepad, the text editor built into Windows 95.

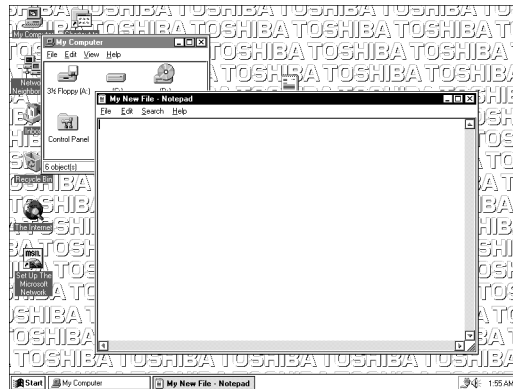

The Notepad window

Notice that as you open the file there's a new button on the taskbar that reads My New File - Notepad (the name may be too long to fit into the taskbar space, but if you point to the name, the system displays all of it). By displaying buttons like this one, the taskbar helps you keep track of the programs and files you currently have open.

To learn more about Notepad, click Help or refer to Windows 95 Help. For now, leave Notepad open and go on to the next lesson.

Lesson 4: Creating a New Folder

Windows 95 stores documents, tools and programs in folders. It even stores other folders in folders. In this lesson, you will learn how easy it is to create folders.

To create a folder in which to store the document you just created, follow these steps.

- 1 Move the pointer to an empty area of the desktop and click the secondary button.**

Windows 95 displays the desktop shortcut menu.

- 2 Point to New, then click Folder.**

Windows 95 creates a New Folder icon on the desktop with the icon name highlighted.

- 3 Type a name for the folder and press Enter.**



- 4 Close the Notepad document you just created by clicking the close button on the right side of the Notepad title bar.**

Windows 95 displays the document as an icon on the desktop.

- 5 Click the document icon and drag it to your new folder.**

The outline of the document icon moves across the desktop.

- 6 Still holding the primary button, position the document icon over the folder icon so the folder icon is highlighted, then release the primary button.**

The document icon disappears into the folder.

- 7 To see your document, double-click the folder icon.**

A window opens and displays the contents of the folder, including your document icon.



- 8 Close the window by clicking its close button.**

Lesson 5: Starting Programs

After you've gained some experience and added some programs of your own, you'll know exactly which program to use for a particular task. This lesson teaches you how to start programs from the desktop, using two of the programs built into Windows 95.

Follow these steps:

1 Click Start, then point to Programs.

Windows 95 displays a list of program folders.

2 Point to Accessories, then click Paint.

Windows 95 opens Paint, a simple drawing program.

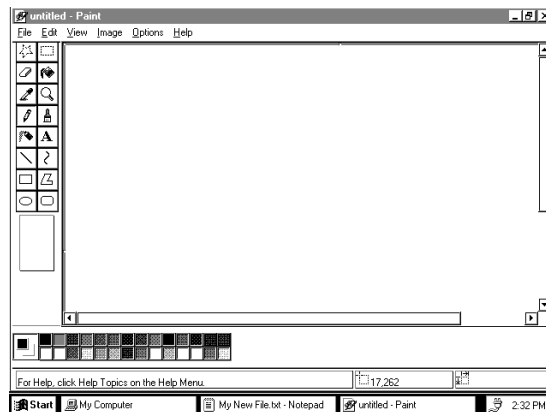

The desktop with Paint open

Your desktop now looks something like the above illustration. Notice again the new addition to the taskbar.

3 To open a second program, click Start, then click Programs.

4 Click Windows Explorer.

Windows 95 opens the Windows Explorer and adds another button to the taskbar.

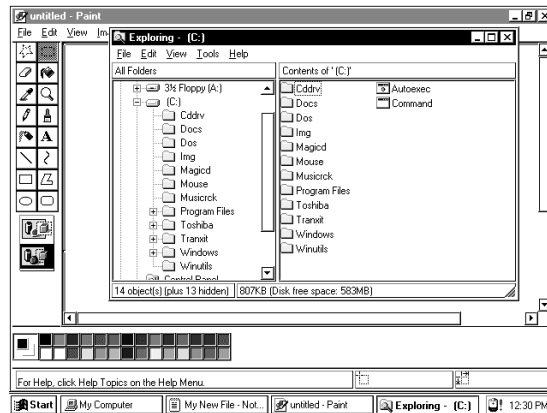

Windows Explorer open on the desktop

The Windows Explorer provides access to all your computer's resources. For example, it lets you see all the files in a particular folder on the computer's hard drive.

Notice the taskbar now has two buttons on it, one for Paint and one for Windows Explorer.

5 Click the Paint button on the taskbar.

Windows 95 displays the Paint program. You can move back and forth between the two programs by alternately clicking each button.

Windows 95 places the active window on top of other windows on the desktop unless you have resized the windows.

Lesson 6: Resizing and Reshaping Windows

If you've been following the steps in this chapter, you now have a screen cluttered with several program windows. Fortunately, it's simple to recreate order out of this chaos. You can resize windows so you can see more than one of them at a time. You can also hide windows by removing them from the desktop without actually closing your document or program.

This lesson introduces several ways to adjust the size and shape of windows open on the desktop.

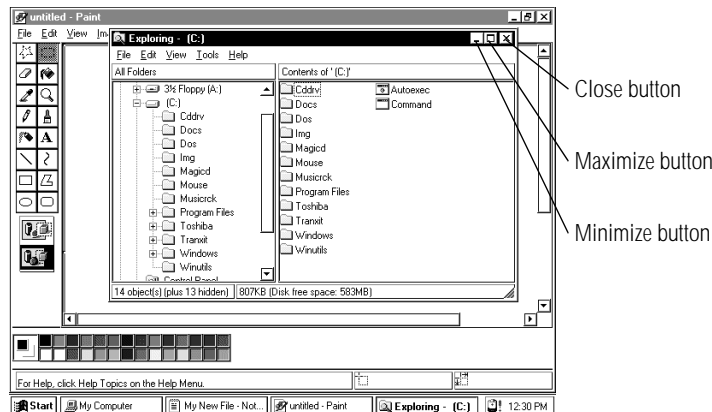

Windows Explorer open on the desktop

First, notice the above illustration. It identifies three buttons that are on the title bars of most windows. These are the **minimize**, **maximize** and **close** buttons. Now that you know where these buttons are, follow these steps:

- 1 To make the Windows Explorer window the active window, click the Windows Explorer button on the taskbar.**

Windows displays Windows Explorer on top of other windows on the desktop and highlights the menu bar to show it is the active window.



- 2 Click the minimize button at the top right of the Explorer window.**

Explorer disappears from the desktop. However, it's still open, as you can see from the taskbar.

Minimizing program windows is a good way to clean up the desktop without actually closing programs.

 **3 Click the maximize button at the top right of the Paint window.**

The Paint window expands to the full size of the screen, except for the taskbar. Notice that the maximize button has changed. It's now called the restore button.

Maximizing a program is a good way to work when you're only using that program and don't want any distractions on the screen.

 **4 Click the restore button.**

Paint returns its previous size and location. Notice that the restore button has changed back into the maximize button.

For the next few steps assume that you want to be able to see both the Paint and Windows Explorer at the same time.

5 Move the pointer to the right side of the Paint window.

The pointer changes to a two-headed arrow.

6 Click and drag the edge of the window until it takes up just less than half the width of the desktop.

7 Click the title bar of the Paint window and, while holding the primary button, drag the window to the left side of the desktop.

You can move any window by clicking its title bar and dragging it.

8 Click the Windows Explorer button on the taskbar.

Windows 95 displays the Windows Explorer window.

9 Repeat steps 6 and 7 to size and position the Windows Explorer, placing it at the right side of the desktop.

Now that you've got the windows side-by-side, you can see how you could refer to one window while working in the other.

When you are working with documents and programs, resizing and moving windows allows you to rearrange the desktop to suit your tastes and needs. Experiment with different sizes and placements of windows. Discover the most comfortable and efficient arrangement for your work.

At this point you have three programs open on the desktop. Go on to the next lesson to learn how to close them.

Lesson 7: Closing Your Programs and Files

Once you've finished working with a document, folder or program, it's a good idea to close it to free up the space in memory for something else. While you can run a number of programs at the same time, a large number of programs and documents open simultaneously can slow down your system.

This lesson teaches you how to close the programs you opened earlier in this chapter. Follow these steps:



- 1 Click the close button at the top right of the Windows Explorer window.**

That's all there is to it. Windows Explorer closes, removing its button from the taskbar.

- 2 Close Paint, and any other windows, folders or programs that might be open by clicking their close buttons.**

You can close all folders, programs, documents and most windows by clicking the close button on the title bar.

Now that you know how to close programs and folders, go on to the next lesson to learn how to save time when you are working on the desktop.

Lesson 8: Creating Shortcuts

By adding shortcuts to your desktop, you can open programs or files with the click of a button. You'll probably want to create shortcuts for the programs you use most frequently. This lesson explains how to create shortcuts to two Windows 95 accessories, Calculator and Character Map.

To create a shortcut, follow these steps.

- 1 Move the pointer to an empty area of the desktop and click the secondary button.**

Windows 95 displays the desktop shortcut menu.

- 2 Click New, then click Create Shortcut.**

Windows 95 displays the Create Shortcut dialog box.

- 3 In the Command line box, type `c:\windows\calc.exe` and click Next.**

Windows 95 prompts you to select a name for the shortcut.

- 4 Type Calculator and click Finish.**

Windows 95 displays the new shortcut on your desktop.

Now assume you want to create a shortcut, but don't know the location of the program.

- 5 Click Start, then point to Find.**

- 6 Click Files or Folders.**

Windows 95 displays the Find dialog box.

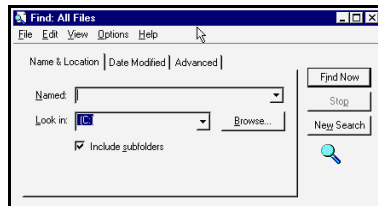

The Find dialog box

7 On the Name and Location tab, type char in the Named box.

8 Click Find Now.

Windows 95 displays a list with all the files with “char” in their names.

9 Click the Character Map file with the secondary button and drag it to the desktop.

Windows 95 displays a shortcut menu.

10 Click Create Shortcut(s) Here.

A shortcut to the Character Map appears on your desktop.

Clicking a shortcut icon opens the program or folder immediately. Place as many shortcuts on your desktop as you find useful.

Lesson 9: Changing the Wallpaper

Windows 95 treats all windows, icons, programs, drives, etc. as self-contained objects. You can set each object’s properties (such as size, position on-screen, and color) individually.

This lesson introduces object properties by showing you how to change one of the properties of the desktop, the wallpaper. Your computer came with the Toshiba wallpaper selected.

To change the wallpaper, follow these steps:

- 1 Move the pointer to an empty area of the desktop and click the secondary button.**

Windows 95 displays the desktop shortcut menu.

- 2 Click Properties.**

Windows 95 displays the Display Properties dialog box.

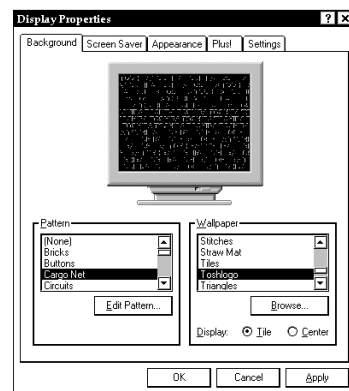

The Display Properties dialog box

- 3 Click the Background tab to bring it to the front.**
- 4 Scroll through the wallpaper pattern by clicking a name in the list box.**

Windows 95 displays a sample of the wallpaper selection in the monitor above the list box. Try several patterns.

- 5 To apply a pattern to your desktop, click Apply.**
- 6 After you've chosen a wallpaper pattern and applied it to your desktop, click OK.**

Windows 95 returns you to the desktop, with the new wallpaper displayed.

You can view any object's properties by clicking it with the secondary button, and choosing Properties from the shortcut menu that appears.

The next lesson explains how to set two other properties: the date and time.

Lesson 10: Setting the Date and Time

You set the computer's date and time properties when you turned the computer on the first time and set up Windows 95. To change the date and time settings now, follow these steps:

- 1 **Click Start, then point to Settings.**
- 2 **Click Control Panel.**

Windows 95 displays the Control Panel.

- 3 **Double-click the Date/Time icon.**

The system displays the Date/Time Properties dialog box.

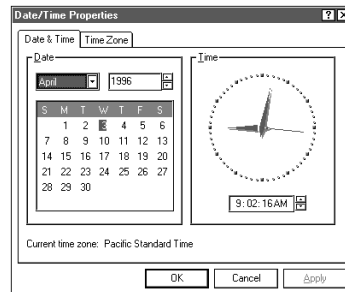

The Date/Time Properties dialog box

This dialog box has two tabs. Click on a tab to bring it to the front.



To open this dialog box more quickly, click the time display on the taskbar with the secondary button, then click Adjust Date/Time.

- 4 **On the Date & Time tab, select the correct month, year, day, and time.**

5 On the Time Zone tab, select your time zone from the drop-down list box.

6 When you've finished, click OK.

Go on to the next section to finish cleaning up the desktop.

Lesson 11: Removing Objects from the Desktop

Earlier in this tutorial, you created some new icons on the desktop. Since everything you've done up to this point has been for practice, you'll want to return the desktop to its original uncluttered state. This lesson explains how to remove objects from the desktop and introduces the Recycle Bin.

To remove your new icons from the desktop, follow these steps:

1 Click the icon for the folder you created in "Lesson 4: Creating a New Folder" and drag it until it's over the Recycle Bin.

2 Release the primary button.

The icon disappears. But, with Windows 95, it isn't really gone. It's merely set aside in the Recycle Bin, from where you can restore or delete it later.

3 Repeat steps 1 and 2 for any other icons you created during this tutorial.

Each icon disappears as you drop it on the Recycle Bin icon.

4 Double-click the Recycle Bin icon.

Windows 95 opens the Recycle Bin window.



The desktop with the Recycle Bin window open

Notice that all the icons you dropped on the Recycle Bin are listed.

5 To completely remove an object, click it and click File, then click Delete.

The object is gone forever.

Later on—in your real work, not in this tutorial—you'll use the Recycle Bin to delete other objects such as folders, documents and even programs. Still, the process is the same. Drag the object's icon to the Recycle Bin and, sometime when you're absolutely certain that you never want to see it again, delete it from there.

If you change your mind and you want to restore an object you sent to the Recycle Bin, click the object with the secondary button and click Restore. Windows 95 restores the object to the place from which it was deleted.



NOTE

To delete all objects from the Recycle Bin at once, choose Empty Recycle Bin from the File menu.

The next lesson explains what to do if you get lost somewhere in Windows 95.

Lesson 12: If I'm Lost—What Do I Do?

Your computer has an excellent help facility. If you can't figure out how to do something, the answer is probably only a few clicks away. This lesson teaches you how to use some of the help features in Windows 95.

Assume that you want to draw a picture but don't know how.

Follow these steps:

1 Click Start, then click Help.

Windows 95 opens the Help window.

2 If you don't see the Index page, click the Index tab.

Help displays the Index page.

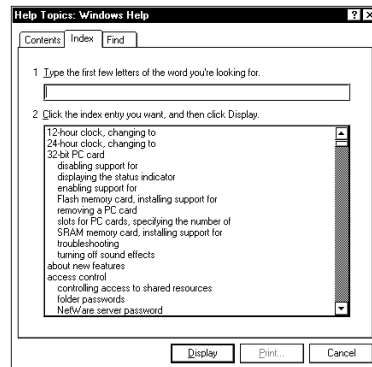

The Help window on the Index page

Most of the window contains a list of topics. The upper part of the window, where the pointer is flashing, lets you type in a topic.

3 Type picture.

Notice as you type that the topic list adjusts to locate what you typed. When you type the letter p, the topic list moves to the first entry that begins with P, etc.

There are a number of topics listed under picture. One of them, drawing, looks promising.

4 Double-click drawing.

Help opens a topic window that explains briefly how to draw pictures, and includes an icon to start the Paint program.

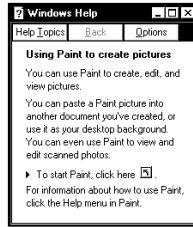

The Drawing help window

5 Click the click here icon.

Windows 95 opens the The Paint program.

Not every help topic window contains an icon to start a program. However, when you do encounter one, it's a great way to move from reading about your question to an instant solution.

6 Just to clean up the desktop, close both Help and Paint by clicking their close buttons.

You're almost done! The next (and last) lesson tells you how to shut down Windows 95 and turn your computer off.

Lesson 13: Turning Your Computer Off

It's very important that you let Windows 95 shut down your computer. As it shuts down, Windows 95 performs a number of tasks that ensure that everything's in place the next time you turn the computer on. This lesson teaches you how to shut down Windows 95.

To turn your computer off, follow these steps:

1 Click Start, then click Shut Down.

Windows 95 displays the Shut Down Windows dialog box.



The Shut Down Windows dialog box

2 Make sure the button next to Shut down the computer is highlighted. If it isn't, click it now.

3 Click Yes.

Windows 95 displays a message that it is shutting down and turns the computer off. When the power is off, the power/speed light goes out.

You have completed the tutorial. You should be comfortable with the desktop and the objects on it. You should be able to open and close programs, create documents and folders and delete them, work with the properties of objects on the desktop and you even know how to find help if you get lost. Continue to use what you have learned in these lessons and, before you know it, you will feel completely at home with your computer.

Learning the Basics

The information in this chapter is intended for the novice computer user. Simple steps describe many day-to-day computer operations. There are also lists of helpful computing tips. By the end of the chapter, you'll have developed many of the basic skills that more advanced users take for granted.

Computing Tips

It seems that everybody's grandmother has a list of rules that will make your life better. This section presents a few rules that your grandmother would include if she were teaching you how to use your computer.

Two Things Every User Learned the Hard Way

- ❖ Save your work frequently.

Both novice and experienced computer users occasionally forget to save their work. When the network you're working on goes down and you must restart your computer to reconnect, or your battery runs out of charge mid-flight, you'll say, "I wish I had saved!"

See the instructions in “How to Save Your Work” on page 86.

- ❖ Back up your files on a regular basis.

It's easy to put off backing up because it takes time. However, if the network crashes and you can't access the network drive without restarting your computer or your hard disk suddenly fails (it's a mechanical device and sooner or later...), you'll wish you had taken the time to do backups.

See the instructions in “How to Back Up Your Work” on page 96.

Five More Things Every Satellite Computer User Should Do

- ❖ Take frequent breaks to avoid repetitive strain injuries and eye strain.

As indicated in “Keep Yourself Comfortable” on page 3, it's important to stay comfortable while you're working at your computer.

- ❖ Exit Windows 95 before turning the computer off, unless Resume Mode is on. See “How to Start Where You Left Off” on page 76 for information about Resume Mode.

Windows 95 records information, such as your Desktop setup during its shutdown procedure. If you don't let Windows 95 shut down, it can forget things such as new icon positions.

- ❖ Set up your computer to fit your tastes and needs.

You're the one that's going to be looking at the screen while you work. If you don't like the colors on the screen, go ahead and change them. See Windows 95 Help for information on changing the appearance of your screen. To open Help, see “Lesson 12: If I'm Lost—What Do I Do?” on page 69.

- ❖ Scan all new files for viruses.

It's unlikely, but possible, even new programs you buy from your local computer store may contain a computer virus. See “Viruses and How To Cure Them” on page 239 for information about detecting and removing computer viruses.

- ❖ Run Create System Disks and Master Disk Creator or purchase master program diskettes.

At some point, you may need installation diskettes for the programs that came pre-installed on your computer's hard disk. See "Create Master Diskettes or Purchase the CD-ROM" on page 35 for more information.

Five Things You Should Never Do

- ❖ **Don't** spill a drink into the computer's keyboard.

If you do spill a drink that gets into the keyboard, turn the computer off immediately and unplug it. Leave the system off overnight to give it time to dry out before you return to work.

- ❖ **Don't** format a disk that contains valuable information.

Formatting removes all the information that's currently on the disk. If your files are important to you, always double-check a disk before you format it.

- ❖ **Don't** turn the computer off when a drive indicator light is on.

Turning the computer off while it's reading from or writing to a disk may damage the disk, the drive or both.

- ❖ **Don't** expose diskettes or the computer to magnetic fields, such as those generated by large stereo speakers.

Information on disks is stored magnetically. Getting a magnet too close to a disk can erase important files.

- ❖ **Don't** be afraid to use your computer, it's just a machine.

Many people are so nervous with their first computer that they forget it's merely a tool. Provided you follow the advice in this manual, you're unlikely to do your computer any harm. So use it and have fun.

When You Turn the Computer On

Between the time you press the power button and the time you get to work, the computer goes through its normal self-test and startup procedure. Skip these steps by using Windows 95's Suspend command or Toshiba's Resume Mode to save time and battery power.

All Those Messages

When you turn the computer on, it flashes a number of messages across the screen before it loads Windows 95. Don't worry if you don't understand any of these messages. They indicate that the computer's going through its normal startup procedure.

If you're really interested in what's going on, there's more information in "What Really Happens When You Turn the Computer On?" on page 266. The next section tells you how to get to work immediately without waiting for all of the messages to appear.

How to Start Where You Left Off

Many times, you'll turn your computer off, intending to continue a bit later. Then, when you're ready to return to work, you turn the power on and wait while the computer displays messages and loads Windows 95, before you can get back to work.

There's an easier way. By using Windows 95's Suspend command or Toshiba's Resume Mode, you can start your computer and have everything back to where it was when you turned the power off. These modes provide a sort of electronic bookmark. They use the computer's backup battery to store the current state in memory while the power is off and, when you turn the computer back on, to restore the state the system was in before you turned the power off.

Using Suspend Mode or Resume Mode is energy efficient. Avoiding the startup procedure, which requires accessing the hard disk drive, saves energy and extends the amount of work you can get done before you must recharge the battery.

Most of the time, you'll find Windows 95 Suspend Mode quite convenient. However, if you want to use Toshiba's System Auto Off and Panel Power On/Off options, you'll need to turn on Resume Mode. For more information about these options, refer to the following sections.

Using the Suspend Command

To turn the computer off using the Windows 95 Suspend command:

- 1 **Save any files you're using over a local area network.**



Your network connection may be lost when you suspend your computer.

- 2 **Click Start.**
- 3 **Click Suspend.**

The Suspend command saves the current system settings, shuts down Windows 95, and turns the computer off.

Using Resume Mode

There are several ways to turn Resume Mode on and off. This section describes how to use a key combination, called a hotkey, to select Resume Mode. This is the quickest method. Turn to "Starting Again Where You Left Off" on page 133 for the other methods.

To select Resume Mode, follow these steps:

- 1 **Start MaxTime, if it's not already running.**
- 2 **Press Fn + F3 to display the power-up pop-up window.**

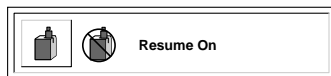

The power-up pop-up window

- 3 While continuing to hold Fn, press F3 until Resume Mode is highlighted.**
- 4 Release the Fn key.**

The system is now in Resume Mode. The next time you turn your computer off and back on, you'll be right back where you left off.



If the system displays the WARNING RESUME FAILURE message when you turn the computer back on in Resume Mode, the computer's backup battery is probably discharged. This may happen if you've had the computer turned off for a long time. Since the backup battery receives its charge from the battery pack, you'll need to charge the battery pack first, then wait approximately seven hours for the backup battery to charge completely.

How to Adjust the Display Panel

Where you use the computer affects how easily you can see the images on the display panel. For example, the display panel may be more difficult to read outdoors in full sunlight than in a dimly lit room. Adjusting the display panel angle often helps, but you may also need to adjust the display brightness.

You can adjust the contrast of the display by rotating the contrast control dial on the right side of the display panel.

You may also adjust the brightness of the display. To adjust the brightness, follow these steps:

- 1 Start MaxTime, if it's not already running.**
- 2 Choose Machine Settings from the Options menu.**

MaxTime displays the Machine Settings dialog box.

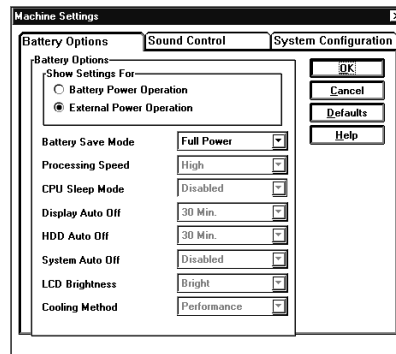

The Machine Settings dialog box

3 Set the LCD Brightness option to Bright.

You can do this two ways:

- ❖ Set the Battery Save Mode to Full Power. This automatically sets the LCD Brightness option to Bright, and changes the other battery save option settings to maximize system performance.
- ❖ Set the Battery Save Mode to User Settings, then set the LCD Brightness option to Bright. This method doesn't affect any other battery save option settings.

4 Click OK to save your settings and exit the Machine Settings dialog box.

For more information about MaxTime, see “MaxTime” on page 311.

How to Start a Program

Starting a program in Windows 95 is as easy as clicking the Start button, pointing to Programs and choosing the program's icon from the Programs menu. Of course, that only works if there is an icon for the program in the Programs menu.

Starting an MS-DOS program from a system prompt is a little more complex. To start an MS-DOS program, see “Starting an MS-DOS Program” on page 81.

Starting a Program from an Icon

To start a program from an icon, follow these steps, which use the Windows 95 Wordpad program as an example:

1 Click Start, then point to Programs.

Windows 95 displays the Programs menu.

2 Point to Accessories.

Windows 95 displays the Accessories menu.

3 Click Wordpad.

Windows 95 opens Wordpad. Wordpad is a text editor—a scaled-down word processor without the frills.

That’s really all there is to it. To close Wordpad, click the close button at the upper right corner of the window.

Starting a Program from the Explorer

These steps demonstrate how to start a program if it is not in the Start menu. To use this method, you need to know the file name and directory of the program you want to start.

This example, like the one above, opens Wordpad, using its file name of WORDPAD.EXE.

To start a program from the Explorer, follow these steps:

1 Click Start, then point to Programs.

2 Click Windows Explorer.

Windows 95 opens the Explorer.

3 In the left part of the screen, under the C: icon, double-click Program Files.

The Explorer shows the contents of the Program Files folder on the right side of the screen. The left side of the screen shows all the folders contained within the Program Files folder.

4 Click Accessories.

The Explorer shows the Accessories files on the right side of the screen.

5 Double-click Wordpad.exe.

Windows 95 opens Wordpad.

Starting an MS-DOS Program

To start an MS-DOS program, follow these steps:

1 Click Start, then click Shut Down.

Windows 95 displays the Shut Down Windows dialog box.

2 Click Restart the computer in MS-DOS mode, then click Yes.

Windows 95 shuts down the computer, then restarts it in MS-DOS mode and displays a system prompt.

3 Refer to the program's documentation for the command that starts the program.

4 At the system prompt, type the command and press Enter.

How to Use the Keyboard

If you've never used a computer before, you're probably asking yourself, "is this keyboard just like a typewriter? And if it is, what are all the extra keys for?" This section describes the keys on the keyboard and the differences between typing on a computer and that typewriter you may be used to using.

The Character Keys

For the letter and number keys, typing on a computer keyboard is very much like typing on a typewriter. However, there are some exceptions:

- ❖ When you press the spacebar, a computer does not simply pass over an area of the page like a typewriter does. Although you may not see anything on the screen, each time you press the spacebar, the computer creates a space character just as it creates characters representing letters or symbols.
- ❖ The lowercase l (el) and the number 1 are not interchangeable.
- ❖ The uppercase O and the number 0 are not interchangeable.
- ❖ On a typewriter, the shift lock key locks all the keys into their uppercase positions. On a computer keyboard, pressing the Caps Lock key changes only the alphabet keys to uppercase—the number and symbol keys aren't affected.

The Other Keys

In addition to the character keys, the computer keyboard contains a number of keys that carry out special computer tasks. This section describes these special keys.

- ❖ The 12 function keys (F1, F2, etc.) across the top of the keyboard carry out program-specific tasks. To find out what these keys do in your program, refer to the program's documentation.
- ❖ The function of the Ctrl key (Control key) also varies according to the program you're using.
- ❖ In Windows programs, pressing the Alt key lets you open menus.
- ❖ Pressing the Fn key simultaneously with one of the specially marked keys allows you to emulate a 101-key keyboard (discussed below), turn keyboard overlays on and off (page 250) and control various system functions.

Toshiba's powerful Fn-esse program lets you assign your own Fn key combination to launch a Windows program or document quickly from anywhere in Windows 95. Instructions for using this program are given in "Starting Programs Faster" on page 241.

Typing Numbers

The keys with white numbers on the right front make up the numeric overlay. This overlay lets you type numbers as you would from a 10-key keypad. The following illustration highlights the keys in the numeric overlay.

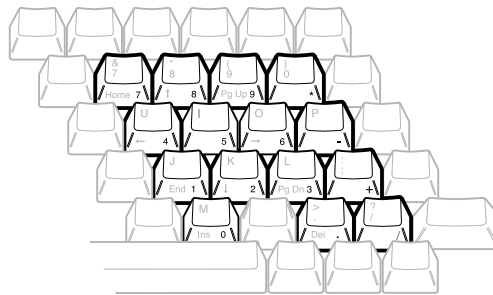

The numeric overlay

To turn the numeric overlay on and off, press Fn + F11. The numeric lock light on the indicator panel shows whether the numeric overlay is on or off.

You can still use the overlaid keys to type alphabetic characters while the numeric overlay is on. To do so:

- ❖ for lower case letters, hold Fn down while you press the keys.
- ❖ for upper case letters, hold Fn + Shift down while you press the keys.

To use the cursor control overlay keys when the numeric overlay is on, press and hold Shift while you use the overlay keys. To return to the numeric overlay, release Fn. The cursor control overlay is discussed in "The Cursor Control Overlay" on page 250.

How to Create Other Symbols

At some point, you may want to create other characters or symbols that are not represented on your keyboard. By typing a simple code, you can produce a variety of symbols and foreign language characters that are part of an extended character set.

Certain word processing programs allow you to insert these symbols directly into your document. Others provide a list of codes needed to create these symbols. In most cases, these codes may vary depending on the font you are using. Refer to your word processor's documentation for specific instructions.

The following lists some commonly used extended characters:

| <i>Symbol</i> | <i>Keystroke</i> |
|---------------|------------------|
| ™ | Alt + 0153 |
| ® | Alt + 0174 |
| © | Alt + 0169 |
| ¼ | Alt + 0188 |
| ½ | Alt + 0189 |
| ¾ | Alt + 0190 |
| é | Alt + 0233 |
| ñ | Alt + 0241 |
| ° | Alt + 0176 |
| – | Alt + 0150 |
| — | Alt + 0151 |

Using Character Map

Character Map is an accessory program included with Windows that displays the keystroke combination needed to create extended characters. To determine the correct keystroke combination for the symbol you want to create, follow these steps:

- 1 Click on Start and point to Programs, Accessories and click on Character Map.**

Character Map displays the available symbols for a particular font.

- 2 From the pull-down menu, select the font you would like to use.**

- 3 Click on the symbol you want to create.**

Character map enlarges the view of the character and displays the keystroke combination in the lower right corner of the window.

Installing Character Map

If you do not have Character Map installed, you can install it using the Add/Remove Programs icon in the Windows 95 Control Panel. To install Character Map, follow these steps:

- 1 Click Start and point to Settings, then click Control Panel.**

- 2 Double-click the Add/Remove Programs icon.**

The Add/Remove Programs Property window appears.

- 3 Click on the Windows Setup tab.**

- 4 From the list of components, double-click Accessories.**

- 5 Select Character Map from the Accessory list and click OK.**

Windows 95 installs Character Map to your desktop Accessories folder.

How to Save Your Work

When you're working on a document, all your work exists in the computer's temporary memory. When you turn the computer off, everything in memory is lost. Therefore it's important to save your files to the hard disk or to a diskette before turning the power off.

Saving documents is quick and easy, and it's a good idea to get in the habit of saving frequently. That way, if you run into trouble, you won't lose many long hours of work.

Many programs offer a feature that saves documents after a set period of time. Check your programs' documentation to see if they have an automatic save feature.

You use the same procedure to save files in all Windows programs. This section describes this procedure.

1 Choose Save from the File menu.

If you're working with a previously existing document, one that already has a file name, that's all there is to it. If you've created a new document, your program displays a Save As dialog box.

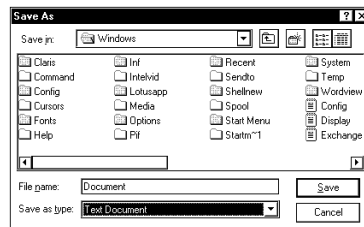

A sample Save As dialog box

You use this dialog box to specify where to store the file and to give it a file name.

2 Choose the drive and folder where you want your file to be stored.

3 Type a file name and choose OK.

Windows 95 supports file names of up to 255 characters, and the names may include spaces.

If you plan on sharing your files with a computer using MS-DOS or an older version of Windows, the file name must be limited to up to eight characters followed by a period and a three-character extension. You may use all the letters and numbers on the keyboard plus the following characters: `_`, `^`, `$`, `~`, `!`, `#`, `%`, `&`, `{`, `}`, `(`, `)`, `@` and `'`. An MS-DOS file name must not contain a space.

Most programs assign an extension that identifies the file as being created in that program with a particular format. For example, Microsoft Word saves files with a `.DOC` extension. While you can create your own extension, this is usually unwise. Using the default for your program is a helpful reminder of where your file came from. Also the program is unlikely to recognize a strange extension and may refuse to handle your file correctly.

How to Print Something You've Created

By this time, you've probably created a document and saved it—if not, save it now. Naturally, you want to see the results of your work by printing your file.

Before you can print your work, you need to have:

- ❖ connected the printer to the computer (discussed in “Connecting a Parallel Printer” on page 24)
- ❖ set up Windows 95 to work with the printer (discussed below)

You only need to perform the setup step the first time you connect the printer. If you'll be using more than one printer or changing printers, you'll need to set up Windows 95 to run with the additional printer(s).

Setting Up Windows 95 to Work with Your Printer

When you turned your computer on for the first time, the Windows 95 Setup program offered you the opportunity to define a printer. Read this section if you didn't have a printer at that time, or want to set up a different printer.

Setting up a printer involves choosing a printer driver. This special program acts as a translator that turns your work into a form the printer can understand. This section describes how to select a printer driver in Windows 95. If you're using any non-Windows programs, you'll need to set up a printer driver for each of those programs. Refer to your program's documentation for more information.

You set up a printer with the Add Printer Wizard. Follow these steps:

- 1 Click the Start button, then point to Settings.**
- 2 Click Printers.**

Windows 95 opens the Printers window.

- 3 Double-click Add Printer.**

Windows 95 opens the Add Printer Wizard.

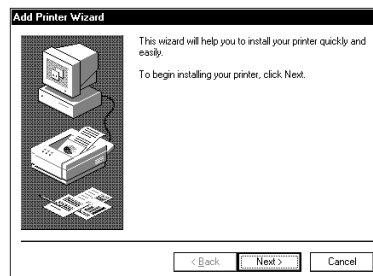

The Printer Wizard

- 4 Click Next.**

The Add Printer Wizard asks you whether you're installing a local or a network printer.



NOTE

If your printer is Plug and Play, Windows 95 recognizes it automatically. You can ignore the remainder of this section.

- 5 If the printer isn't connected to a network, select Local printer and click Next.**

If the printer you're setting up is connected to a network, select Network printer and click Next.

The Add Printer Wizard asks you to select your printer.

6 From the list of manufacturers and printers, select your printer and click Next.

The Add Printer Wizard asks for the printer port.

7 Select the port settings according to the instructions in your printer's documentation and the port to which your printer is connected, then click Next.

The Add Printer Wizard asks you to enter a "friendly" printer name.

8 Enter a name for your printer.

If you're using more than one printer, make sure the name is descriptive enough to help you tell the difference.

9 If you want this printer to be the default printer for Windows 95, click Yes, then click Next.

If you don't want this printer to be the default printer, click No, then click Next.

Windows 95 prompts you to print a test page.

10 If your printer is connected and turned on, choose Finish to print a test page.

To finish the setup procedure without printing a test page, choose No, then Finish.

You're ready to print.

Printing Your Work

Once you have set up your printer and software correctly, it requires only a simple action to print a file from within a Windows application. Follow these steps:

1 Turn your printer on if it's not already on.

2 Choose Print from the File menu of your Windows application.

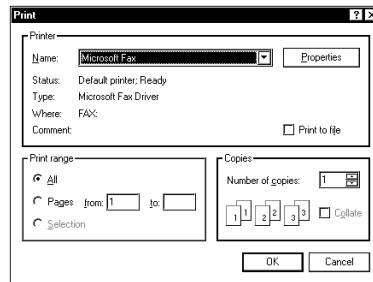

A sample Print dialog box

3 Choose OK to print.

That's all there is to it. Depending on your application, you may see different messages indicating the status of your print job.

Using the CD-ROM Drive

CD-ROMs are easy to use. You insert them while the computer is on, and change compact discs whenever you want to (as long as the system is not reading from the disc).

Once you insert a CD-ROM into the drive, refer to the documentation provided with the compact disc to perform any necessary installation procedures.

Inserting a CD-ROM

To insert a compact disc into the CD-ROM drive, follow these steps:

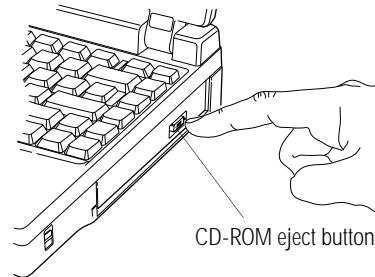

Pressing the CD-ROM eject button

- 1 With the power on, locate and press the CD-ROM eject button on the right side of the computer.**



NOTE

The CD-ROM drive won't open if the computer's power is off.

The CD-ROM drive slides partially open (about one inch).

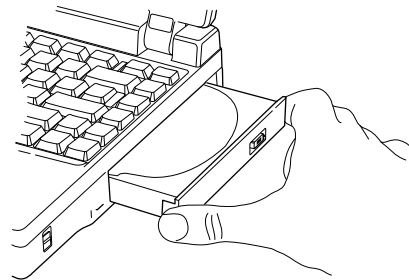

Opening the CD-ROM drive

- 2 Grasp the sides of the CD-ROM tray and pull the drive the rest of the way open.**

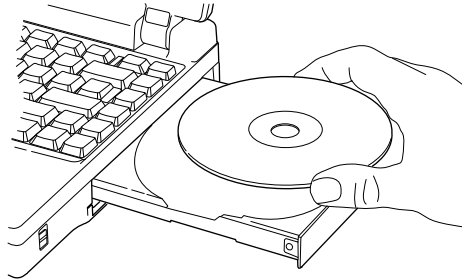

Placing the compact disc in the drive

- 3 Check the compact disc to make sure it is free of dust before inserting it.**
- 4 Carefully place the compact disc in the drive (with the label facing up).**

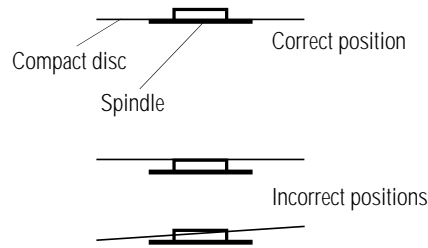

Positioning the compact disc on the spindle

- 5 Gently press the compact disc onto the center spindle until you feel it click into place.**

Make sure the disc is completely on the spindle and is lying flat.

- 6 Push the CD-ROM tray in by pressing gently on the center of the tray until it clicks into place.**

You're ready to use the CD-ROM.



Before moving the computer, even just across the room, remove the CD-ROM from the drive and place it in a safe place where it will not be damaged.

Removing a CD-ROM

To remove a compact disc from the CD-ROM drive, follow these steps:

- 1 With the power on, press the CD-ROM button on the right side of the computer.**

The CD-ROM drive slides partially open.



If the CD-ROM drive doesn't open, for example, if the battery is drained and you can't turn the power on, you can open the drive manually. Use a straightened paper clip or other object to press in the eject hole just to the right of the CD-ROM eject button.

- 2 Grasp the sides of the CD-ROM tray and pull the drive the rest of the way open.**
- 3 Remove the compact disc and place it in its protective cover.**
- 4 Push the CD-ROM tray in to close the drive.**

How to Prepare Diskettes for Use

Formatting makes it possible to use a diskette. You don't really need to know what's going on when you format a diskette, but if you're interested, the details are covered in "How Does a Disk Store Information?" on page 262.

You can buy two types of diskettes: preformatted and unformatted. If you've purchased preformatted diskettes, you don't need the information in this section because the diskette manufacturer has taken care of the process for you. If the package doesn't say anything about formatting, your diskettes are probably unformatted.

This section describes the simplest way to format a diskette. For more options, and an explanation of the other items in the Format dialog box, see Windows 95 Help or your Windows 95 documentation.

To format a diskette, follow these steps:

- 1 If your diskette drive is not installed in the SelectBay, connect the external diskette drive or swap drives in the SelectBay. To swap drives, see “Swapping Drives in the SelectBay” on page 104.**
- 2 Insert a write-enabled diskette into the diskette drive.**

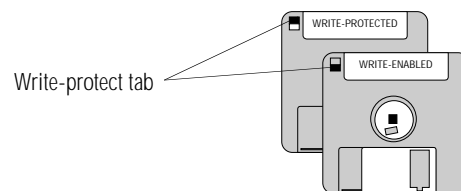

Write-protected and write-enabled diskettes

The tab at the left corner of the diskette should cover the square hole (see diagram on page 36).



Formatting a disk erases all information currently on the disk. Do not format a disk unless you're sure it's blank or contains only files you no longer need.

3 Double-click My Computer.

Windows 95 opens the My Computer window.

- 4 Click the drive A: icon with the secondary button, then click Format.**

Windows 95 opens the Format dialog box.

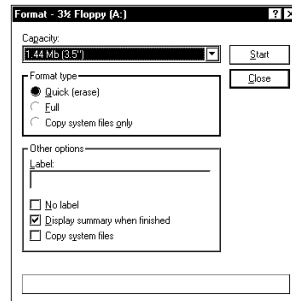

The Format dialog box

The options in the Format dialog box are already set to format your diskette.

5 Click Start.

Windows 95 formats the diskette, displaying the Format Results screen when it's finished.

6 Click Close.

7 Close the My Computer window.

How to Copy Something to a Diskette

Diskettes provide an easy means of transferring files from one computer to another. Copying a file to a diskette also gives you a backup copy in case something happens to the original on your hard disk. This section describes how to use the My Computer window to copy a file from the hard disk to a diskette.

To copy a file from the hard disk to a diskette, follow these steps:

- 1 If your diskette drive is not installed in the SelectBay, connect the external diskette drive or swap drives in the SelectBay. To swap drives, see “Swapping Drives in the SelectBay” on page 104.**
- 2 Insert a formatted diskette into the diskette drive. If you're unsure how to format a diskette, refer to “How to Prepare Diskettes for Use” on page 93.**

3 Double-click My Computer.

Windows 95 opens the My Computer window.

4 Double-click the drive that contains the file you want to copy.

Windows 95 displays the contents of the drive.

5 Double-click the folder that contains the file, then click the file you want to copy.

As in earlier versions of Windows, you can use the Ctrl and Shift keys to select more than one file.

6 Click File, then click Send To.**7 Click the icon for the diskette drive (drive A).**

Windows 95 copies the file(s).



You can also copy a file to diskette by clicking the file (or files) you want to copy with the secondary button, then pointing to Send To and clicking 3.5-inch Floppy (A).

How to Back Up Your Work

Murphy's law applies to everything—even computers. Therefore, it's a good idea to make a copy of everything on your computer's hard disk and store it in a safe place. This is called backing up your files. That way, if you somehow press the Delete key accidentally, you'll be able to recover your files quickly and easily.



Murphy's Law: If anything can go wrong, it will, at the worst possible moment.

Your computer comes with Microsoft's Windows 95 backup program pre-installed on the hard disk. Other backup programs are available at many computer stores.

This section explains how to use the backup program to back up all the files on your hard disk. Making backup copies of your computer's hard disk is not a one-time event. You should develop a regular habit of making backup copies of your hard disk. Complete information on the backup program, including instructions for backing up only a portion of the files on your hard disk, is in Help and your Windows 95 documentation.



Backing up all the files on your hard disk takes a considerable amount of time and lots of diskettes. However, in the unlikely event that you lose some or all of the information on your hard disk, you'll be glad you spent the time.

To back up all the files on your hard disk to diskette, follow these steps:

1 Attach the backup drive:

- ❖ If you're backing up your hard disk to diskettes, connect the external diskette drive or install the diskette drive module in the SelectBay.
- ❖ If you're backing up your hard disk to a tape drive or other external device, connect the drive to the computer, following the instructions provided with the drive.

2 Click Start, then point to Programs.

3 Point to Accessories, then point to System Tools.

4 Click Backup.

Windows 95 opens the Backup window.

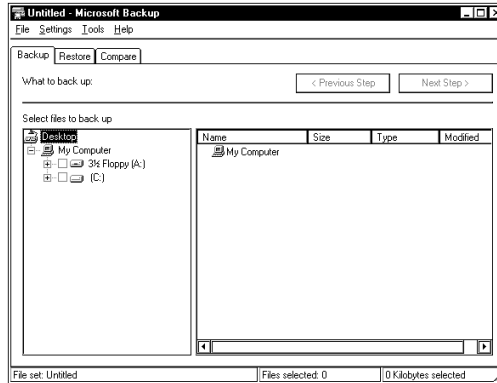

The Backup window

- 5 Click the files and folders you want to back up.**
- 6 Click Next Step.**
- 7 Select the drive to which you are backing up your files (the diskette drive or any external drive you connected).**
- 8 Click Start Backup.**
- 9 Type a name for the backup.**
- 10 Insert new diskettes as Backup instructs you to do so (if you're backing up to diskette).**

To restore information from your backup to your hard disk, use the Restore page in the backup program. Check Help or your Windows 95 documentation for information on restoring files.



When you're restoring files, the backup program prompts you if you try to overwrite a file that already exists on the hard disk. Make sure the backup version is the one you want before overwriting the existing file.

Transferring Files to Another Computer

You've learned how to use diskettes to copy files from one computer to another. Unfortunately, a high-density diskette can only hold 1.44 MB, a serious limitation if you want to transfer a large amount of information. There are several other ways. One is to use the Windows 95 briefcase. See Windows 95 Help for more information about the briefcase.

Another way is the TranXit™ program, included with your computer, which lets you transfer files through your computer's serial, parallel or infrared ports.



The steps in this section provide an overview of how to use TranXit to transfer files. For more detailed information about TranXit, refer to the program's on-line help.

To use TranXit to transfer files, you'll need one of the following:

- ❖ To use the serial port, you'll need a null modem serial cable.
- ❖ To use the parallel port, you'll need a LapLink-compatible parallel cable.
- ❖ To use the infrared port, you'll need another computer with either an internal or external infrared port.

Set Up Your File Transfer

To set up your file transfer, follow these steps:

1 Use one of these methods to connect the two computers:

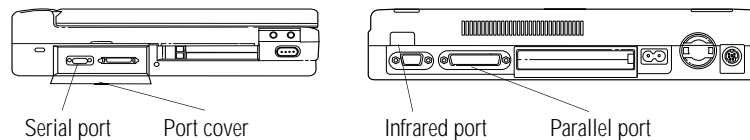

The left side and back of the computer

- ❖ For a serial connection, open the port cover on the left of the computer and connect the serial cable to the serial port. Connect the other end of the cable to the **serial port** on the other computer.
 - ❖ For a parallel connection, connect one end of the parallel cable to the **parallel port** on the back of the computer. Connect the other end to the parallel port on the other computer.
 - ❖ For an infrared connection, aim the computer's **infrared port** directly at the infrared port on the other computer. The two computers must be within 3 feet (1 meter) of each other.
- 2 **On one of the computers, click Start, then point to Programs.**
 - 3 **Point to TranXit2, then click TranXit.**
Windows 95 opens the TranXit program.
 - 4 **Choose Connection from the Setup Menu.**
 - 5 **If an appropriate Configured Connection is available, choose it and go on to step 9. Otherwise, continue with the next step.**
 - 6 **Choose the appropriate type of connection in the Connection Type list.**



The model name for infrared devices is Generic. Whether you should use fixed or variable mode depends on the device you're connecting to and what its settings are. Fixed mode should work for other computers running TranXit, but you may need to use variable mode to connect to infrared equipped printers.

- 7 **Choose the Setup Connection button.**
- 8 **Choose the port setting for the computer and choose OK.**
- 9 **Click the Enable Connection check box.**

An X in the box indicates that a connection is enabled.

- 10 Choose OK to accept the current settings.**
- 11 Repeat steps 2 through 10 on the other computer, making sure that the connection has been set up identically on both computers.**



Make sure the second computer has a different name than the first computer. If the two names are the same, you won't be able to establish a connection.

Transfer Your Files

Now that you're set up, it's time to transfer your files. Follow these steps:

- 1 If you haven't already done so, start TranXit on both computers.**
- 2 Click the File Transfer tab, bringing the File Transfer page to the front, on both computers.**



The connection status icon (the one that looks like a traffic signal) indicates your connection status:

- ❖ A red light indicates that a connection has not been enabled or no connection has been established.
 - ❖ A yellow light indicates that TranXit is trying to establish a connection.
 - ❖ A green light indicates that a connection has been established.
- 3 When the connection status icon is green, open the Options window on one computer.**
 - 4 If Auto New Window is checked, press Esc to close the Options menu.**

If it is not checked, choose Auto New Window.

5 Drag the desired file(s) to the destination drive or directory (folder) icon.

TranXit asks you to confirm the operation.

6 Click Yes to proceed with the file transfer.

7 When you've finished transferring files, click the close button to close TranXit.

Connecting to a Network

Although your computer is designed to be carried around on your travels, there may be times that you want to tap into your company's network. This section gives tips on how to connect your computer to an existing network.

Since most of the details in connecting to a network depend upon the network operating system your company uses and the type of cabling or wireless system installed, this section gives only a brief overview specific to your Satellite 200 Series computer. Talk to your network administrator for assistance in getting up and running on your network.

What Do I Need to Connect to a Network?

Before you can connect to a network, you need to purchase a network adapter card. These come in two forms that will work with your computer:

- ❖ PCMCIA-compatible PC network adapter card
- ❖ Parallel network adapter

The PC Card runs faster, but takes up one of your PC Card slots. The parallel adapter leaves more space for PC Cards and can be connected so that you can still use a parallel printer.

Making the Connection

Connecting to a network requires these general steps:

1 Insert the PC network adapter card in the slot.

Windows 95 automatically detects the card and installs the software for it.

2 Enter the network information.

Ask your network administrator for the Workgroup name and other requested information.

3 Click Close.

Windows 95 copies the necessary network files, then prompts you to restart your computer.

4 Click Yes.

Windows 95 restarts and prompts you to enter your name and password.

5 Type your name and password and click OK.

To connect to another type of network, refer to Windows Help, your network adapter documentation, and ask your network administrator for assistance.

Networks and Suspending the Computer

If you're connected to a network, don't suspend the computer. Not all networks and programs work with Windows 95's Suspend command and Toshiba's Resume Mode. When you turn the computer back on after suspending, you may lose access to your network drives and programs. If this happens restart your computer. If the computer is locked up or not responding, press the reset button to restart.

Swapping Drives in the SelectBay

At times, you may want to install the diskette drive into the computer and leave the CD-ROM drive at home. This section describes how to swap a different drive into the SelectBay.

To use the CD-ROM drive, you'll have to install it in the computer's SelectBay. The external chassis only works with the diskette drive.



Make sure the power is off before you swap a drive into or out of the SelectBay. Removing or inserting a drive while the computer is on may damage the computer, the drive or both.

Remove the Diskette Drive from the External Chassis

If you're installing the diskette drive into the SelectBay, the first step is to remove the drive from the external chassis.

If the diskette drive is currently in the SelectBay, the external chassis is empty. Proceed to the next section.

Follow these steps:

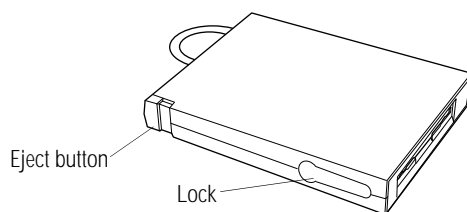

Releasing the drive in the external chassis

- 1 With one hand, press and hold the drive lock.**
- 2 With the other hand, firmly press the drive eject button.**

The drive partially ejects from the chassis.

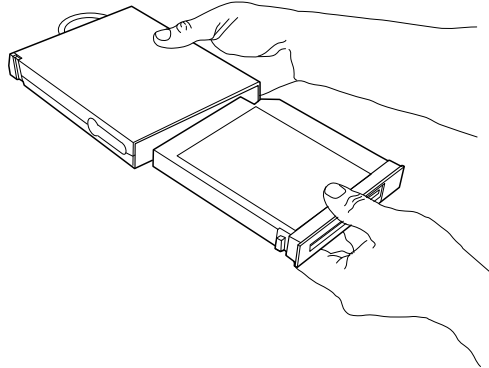

Removing the diskette drive from the external chassis

- 3 Pull the diskette drive out of the chassis and set it aside.**

Prepare the Computer

Follow these steps to prepare the computer for switching drives:

- 1 Shut down the computer.**

To return to work more quickly, use the Suspend command or Resume Mode to turn the computer off. See “Starting Again Where You Left Off” on page 133 for more information.



Make sure the power is off before you swap a drive into or out of the SelectBay. Removing or inserting a drive while the computer is on may damage the computer, the drive or both.

- 2 Disconnect the power cord and any other cables.**

Remove the Drive from the SelectBay

Follow these steps to remove the drive from the SelectBay:

- 1 **Turn the computer upside down with the front of the computer facing you.**

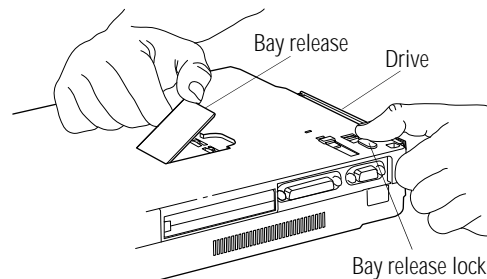

Releasing the drive from the SelectBay

- 2 **Slide the bay release lock toward the rear of the computer.**
- 3 **Pull up on the bay release until the drive ejects slightly.**



Pull the release only as far as needed to eject the drive. The release is not intended to be pulled straight up.

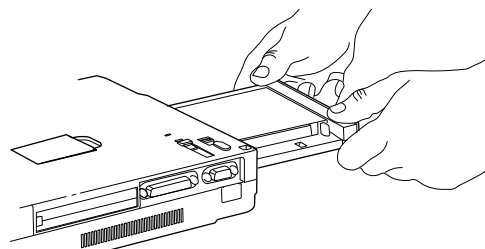

Removing the drive from the SelectBay

- 4 **Grasp the drive and pull it out.**
- 5 **If you removed the diskette drive from the SelectBay, slide it into the external chassis until you feel it click into place. If you removed the CD-ROM drive, set it aside.**

Install the Drives

To install the drive, follow these steps:



*Do not insert the CD-ROM module into the external chassis.
The drive operates only when installed in the SelectBay.*

- 1 Slide the drive into the SelectBay until you feel it click into place.**
- 2 Press down on the bay release until it is flush with the bottom of the computer.**
- 3 Slide the lock toward the front of the computer to lock the drive into place.**

How and When to Turn the Computer Off

It's a good idea to turn your computer off when you're not using it for an extended length of time. There are, however, several things to keep in mind when you want to turn off the power:

- ❖ Use either Windows 95 Shut Down or Suspend command to turn the computer off. To automatically return to where you left off after shutting down the computer, use the Windows 95 Suspend command instead of Shut Down. If you're using battery power, this also saves power.
- ❖ Don't turn the power off if the disk-in-use light on the indicator panel is on. Doing so may damage your hard disk or diskette drive.
- ❖ If Resume Mode is turned off, shut down Windows 95 before you turn the computer off.
- ❖ If you close the display panel while the computer is on, it beeps loudly. To prevent this alarm from going off in the future, use MaxTime or TSETUP to set the Panel Close Alarm option to Disabled. See "MaxTime" on page 311 or "TSETUP" on page 341 for more information.

To turn the computer off, press and hold the power button until you hear a beep.

Caring for Your Computer

This section offers easy tips on looking after your computer. For information about caring for the computer's battery, see "Looking After Your Battery" on page 143.

Replacing the AccuPoint Cap

Over a period of time, your AccuPoint cap may become worn from use. If your finger slips off the AccuPoint, you should replace the cap with a new one included with your computer.

To replace the AccuPoint cap, follow these steps:

- 1 Remove the worn cap by grasping it firmly and pulling it straight up.**
- 2 Position a new cap on the AccuPoint peg and push down until it is firmly seated on the peg.**



NOTE

The AccuPoint peg is square. Be sure to align the square hole in the cap with the square peg.

Cleaning the Computer

To keep your computer clean, perform the following tasks regularly:

- ❖ Clean the exterior case of the computer with a lightly dampened cloth.
- ❖ To clean the screen, dilute a glass cleaner by adding an equal amount of water. Spray a small amount of the diluted cleaner on a cloth and gently wipe the screen.



Keep liquid, including cleaning fluid, out of the computer's keyboard, speaker grill and other openings. Never spray cleaner directly onto the computer. Never use harsh or caustic chemical products to clean the computer.

- ❖ Ask your Toshiba dealer for suggestions for appropriate cleaning products.

Moving the Computer

Your notebook computer is built to withstand reasonable shock and vibration. Before carrying or transporting your computer, follow these steps:

- 1 Make sure all disk activity has ended (the drive indicator light stops glowing).**
- 2 Turn the computer off.**
- 3 Disconnect the power cord.**
- 4 Disconnect the external diskette drive.**
- 5 Disconnect all external optional devices.**
- 6 Close the display panel.**



Do not pick up the computer by its display panel or by the back (where the ports are located).

For long trips, transport the computer in a carrying case. You can purchase a carrying case from your Toshiba dealer or through the Toshiba Accessory Catalog.

Before You Go to a Computer Store

If you're new to computers, buying computer equipment and programs (software) can be a confusing experience.

This chapter provides advice and explains what you need to know to purchase programs and devices that will work with your Satellite 200 Series computer.

Buying Programs

The entertainment, business and personal programs you can buy is enormous.

Your computer comes with a 3.5-inch diskette drive and a CD-ROM drive, allowing you to buy programs either on diskettes or on CD-ROM (compact disc).

Buying programs on CD-ROM rather than diskettes saves you the time it would take to insert and remove all those installation diskettes, and eliminates the possibility of encountering a damaged diskette in the middle of a multi-diskette software installation.

What Types of Programs Can I Buy?

The following sections describe some types of programs that may fit your needs.

If You're a Writer

Almost everyone needs a word processor. This includes professional writers as well as others who use computers for daily correspondence.

To go beyond working with text and create a book, an advertisement or a newsletter you'll need a desktop publishing program.

If you are a public speaker, a presentation package can help you design professional-looking overheads, handouts, questionnaires and announcements.

If You Want to Draw

If you are a graphics artist or a creative artist, a variety of flexible two- and three-dimensional drawing programs are available. Some require a tablet connected to your computer through the serial port.

If You're an Accountant or Financial Analyst

There are a number of outstanding spreadsheet programs on the market. In addition, personal and professional accounting software is a category you should investigate.

If You're a Designer

Your computer dealer can introduce you to a variety of sophisticated design programs including programs to design a garden, or to build or remodel a house, as well as the more common Computer Aided Design (CAD) tools.

If You're a Researcher or Student

On-line services such as CompuServe, America Online and Prodigy, and access to the Internet provide almost endless resources for conducting professional research.

In addition, you can purchase dictionaries, and other reference materials on disk or CD-ROM for your own personal library.

Understanding the Information on the Box

In addition to listing the features of the product on the box, the manufacturer usually prints the system requirements.

Below is an actual example of the system requirements for a graphics program. Your computer meets all of these requirements.

Minimum Requirements: Microsoft Windows 95, 8 MB of RAM, VGA video adapter, mouse or other pointing device, 55 MB of free hard disk space.

Recommended: SVGA video adapter and monitor, sound card and speakers, CD-ROM drive.

The following sections explain each of the characteristics above.

Windows Compatibility

The Satellite 200 Series computer comes with Microsoft Windows 95. Windows 95 can run programs written for Windows (version 3.0 or later), Windows for Workgroups (all versions), and MS-DOS. When possible, use programs written specifically for Windows 95.

MPC Compatibility

The Multimedia Personal Computer (MPC-2) specification was designed to ensure compatibility between multimedia programs and hardware. Your computer is MPC-compliant, allowing you to use all multimedia programs that are themselves MPC-compliant.

Processor

The Satellite 200 Series computer has a 100 MHz Intel Pentium microprocessor. It will run programs requiring a 286, 386, 486 or Pentium processor.

Memory

The Satellite 200 Series computer comes with 8 MB of EDO DRAM. Unless you've added additional memory, use this number when evaluating program requirements. Some programs may list two memory numbers: an amount which is essential for running the program and a recommended amount for better performance.

To check your system's RAM, follow these steps:

- 1 Click the My Computer icon with the secondary button, then click Properties.**

Windows 95 displays the System Properties folder.

- 2 Click the Performance tab.**

Windows 95 displays your computer's performance status, including the amount of memory installed in your computer.

Hard Disk

The Satellite Series hard disk drive has a capacity of 810 million bytes, which is equivalent to 772 MB. Although these capacities well exceed the 55 MB stated in the system requirements example, it is the amount of available hard disk space that matters. Much of your hard disk may be filled with programs and data.

To determine the available space on your hard disk, follow these steps:

- 1 In the desktop, double-click the My Computer icon.**

Windows 95 opens the My Computer window.

- 2 Click (don't double-click) on the C: icon.**

Windows 95 displays the space remaining (Free Space) and total capacity of the drive at the bottom of the My Computer

window. These numbers are listed in megabytes (MB). See “How Big Is a Megabyte, Anyway?” on page 263 for more information on megabytes.

If you can't see these numbers, widen the window until you can see them. To resize a window, see “Lesson 6: Resizing and Reshaping Windows” on page 60.

Graphics Card

A graphics card is also called a display adapter. It may be a board installed in a desktop computer or a chip, as in the Satellite 200 Series. Program requirements are generally listed by the type of adapter or the maximum resolution the adapter supports.

The Satellite 200 Series display adapter is compatible with the VGA (Video Graphics Array) and SVGA (Super VGA) standards. The adapter has a maximum resolution of 1024 x 768 pixels. For programs requiring resolutions higher than 800 x 600, you'll need an external monitor or the internal display's virtual display mode. See “Using an External Monitor” on page 211 for more information about connecting an external monitor to your computer. Information about virtual display mode is found in “Changing the Display Mode” on page 257.

Sound Card

Your Satellite 200 Series computer has a SoundBlaster Pro compatible sound card that provides microphone, headphone and line-in jacks and a volume control dial.

Pointing Device

The AccuPoint is a pointing device that performs all the functions of a mouse.

If a program requires a joystick, you can connect your computer to a NoteDock,TM then connect your joystick to the NoteDock's joystick port. Or you can connect a joystick equipped with a PC Card interface to your PC Card slot on your computer. Your dealer can tell you which joysticks are compatible with your computer.

Tips on Buying Programs

Before you buy:

- ❖ It's a good idea to see a demonstration of the program.
- ❖ Talk to friends and your company's computer experts about the programs they recommend.
- ❖ Check the Internet or on-line services for information about new programs.
- ❖ Make sure you have enough space available on the hard disk.

For more information, see "Hard Disk" on page 114.

- ❖ Make sure your computer has enough memory.

For more information, see "Memory" on page 114.

Installing Programs

Windows 95 makes installing programs onto your computer's hard disk easy. Most programs come with an installation program on diskette or CD-ROM. By following the steps in this section, you'll ensure that your installation program installs the program files completely and sets them up to run with Windows 95.

To install a new program in Windows 95, follow these steps:

- 1 Click Start, then point to Settings.**
- 2 Click Control Panel.**

Windows 95 opens the Control Panel.

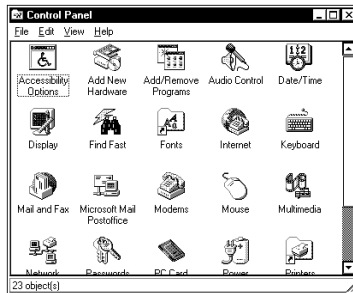

The Control Panel

3 Double-click the Add/Remove Programs icon.

Windows 95 opens the Add/Remove Programs Properties panel.

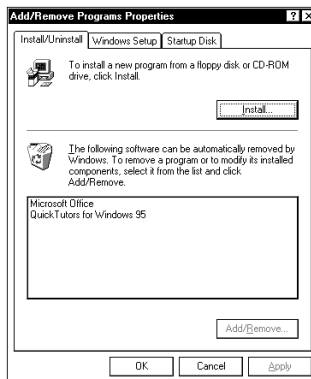

The Add/Remove Programs Properties panel

4 Click the Install/Uninstall tab.

The Install/Uninstall page moves to the front of the panel.

5 Click Install.

6 Insert the program's installation diskette or CD-ROM into the drive.

If you're installing a program from diskette and your diskette drive is not installed in the SelectBay, connect the external diskette drive or swap drives in the SelectBay. To swap drives, see "Swapping Drives in the SelectBay" on page 104.

7 Click Next.

Windows 95 searches the installation diskette or CD-ROM for the installation program.



If Windows 95 doesn't find the installation program or searches the wrong drive, click the Browse button and find the installation program manually.

8 Click Finish to run the installation program.

9 Continue with the program's normal installation process.

Creating a Backup Copy of Program Diskette(s)

It's important to create backup diskettes for any programs you install on your computer, in case you accidentally damage or lose the original program diskettes. You'll need one blank, formatted diskette for each program diskette you have to copy.

Follow these steps:

1 If your diskette drive is not installed in the SelectBay, connect the external diskette drive or swap drives in the SelectBay. To swap drives, see "Swapping Drives in the SelectBay" on page 104.

2 Place the original diskette into the diskette drive.

3 From the desktop, double-click the My Computer icon.

Windows 95 opens the My Computer window.

4 Click the A: icon.

5 Click File, then click Copy Disk.

6 In the Copy Disk dialog box, click Start.

Windows 95 copies the files on the diskette into memory and displays a message asking you to insert the destination diskette (the one you're copying to) into the diskette drive.

7 Remove the original diskette from the diskette drive and replace it with your blank one.

8 Click OK.

Windows 95 copies the files onto the new diskette.

9 If you have more than one diskette to copy, repeat steps 2 through 8 for each diskette.

10 Store the original diskettes in a safe place.

Buying Hardware

In addition to the basic system requirements, some programs require devices such as a modem or printer. These items are available as add-on devices for your computer.

What Kind of Devices Can I Buy?

Many devices, such as fax/modems, removable hard disk drives, and network adapters are available as PC Cards. For more information about these cards, see "Little Cards That Do Big Things" on page 173.

The Toshiba Accessories Catalog lists the add-on devices you can purchase from Toshiba. Talk to your dealer about these Toshiba options and other third-party devices.

This manual also lists a large number of available options. To find these, try looking in the Index under "devices."

Tips on Buying Hardware

- ❖ If a device is cheaper than you think it should be, it may be an older version. On the other hand, depending on your needs, an older version may suit you just fine.
- ❖ Check the Internet or an on-line service information about the product.
- ❖ Check Toshiba's BBS or the Toshiba Forum on CompuServe (refer to "Contacting Toshiba" on page 297 for instructions) and search for information about using the new hardware with your computer.
- ❖ Check the warranty and support policy.

Taking Your Computer on the Road

Probably the main reason you bought a notebook computer was so you could use it in a variety of places. Of course, some of the places you'll be using it may not have a convenient power source.

This chapter describes all the aspects of running your computer while traveling.

Toshiba's Energy-Saver Design



Toshiba is a partner in the Environmental Protection Agency's (EPA) Energy Star Program. As an Energy Star Partner, Toshiba designed this product to meet the Energy Star guidelines for energy efficiency.

The Satellite 200 Series computer enters a low-power, stand-by state when it is not being used, thereby conserving energy and saving money in the process. It has a number of other features that enhance its energy efficiency.

Many of these energy-saving features have been set by Toshiba. By leaving these features active, your computer will operate at its maximum energy efficiency.

Running the Computer on Battery Power

The Satellite 200 Series computer contains a removable NiMH battery pack that provides power when you are away from an AC outlet. You can recharge the battery many times. If you spend a lot of time on the road, you may purchase additional batteries, giving you the potential of many more working hours away from a power source.

To charge the battery, plug the computer into a live wall socket. The battery charges when the computer is on or off. It takes up to two hours to charge the battery with the computer off, or approximately three to six hours when the computer is on.

There is also an optional battery charger that charges up to two batteries at the same time. See “Charging More than One Battery at a Time” on page 144 for more information about the battery charger.

Aside from the battery pack that powers the computer, there are two additional batteries: the backup battery and the real-time clock (RTC) battery. These batteries quietly go about their business in the background, you never have to worry about them. If you're really curious about these batteries, see “What Other Batteries Does the Computer Have?” on page 261.

Monitoring Battery Power

The computer's battery light gives you an indication of the current battery charge. The possible states of the battery light are:

- ❖ Green indicates a full charge.
- ❖ Orange indicates the battery is charging.
- ❖ Flashing orange indicates that the charge is running low.

Toshiba's MaxTime program also contains a battery gauge that lets you check how much time you have before the power runs out. You can set the MaxTime gauge so that it is always visible, providing a constant reminder of your current battery state.

This section describes how to use MaxTime to monitor the battery charge. To learn more about MaxTime, read the complete description of MaxTime features, which starts in “MaxTime” on page 311.

The computer calculates the remaining battery charge as it operates, based on your current rate of power use.



The computer drains battery power more quickly at low temperatures. Check your remaining charge frequently if you're working in temperatures below 50 degrees Fahrenheit.

Displaying the Battery Gauge

The battery gauge window is the first screen you see when you open MaxTime. If MaxTime is not already open, follow these steps:

- 1 Click Start, then point to Programs.**
- 2 Point to Toshiba Utilities, then click MaxTime.**

MaxTime displays a window showing the battery gauge:



The MaxTime battery gauge

The illustration above shows the battery gauge in two different forms: a bar graph and a percentage. The next section describes how to choose between these forms.

Changing the Appearance of the Battery Gauge

The battery gauge comes in two different forms, called modules. Each provides the same information in a different way:

- ❖ The Bargraph module displays the current battery charge as a horizontal bar graph.

- ❖ The Percent Remaining module displays the current battery charge as a percentage of battery capacity.

To set the module(s) you want displayed, follow these steps:

1 Choose Display from the MaxTime Options menu.

MaxTime opens the Display dialog box.

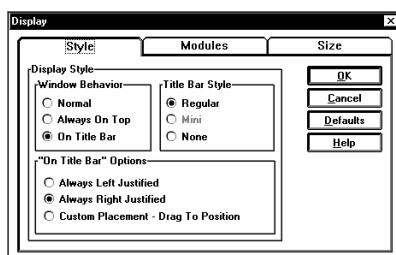

The Display dialog box

2 Choose the Modules page by clicking the Modules tab.

MaxTime displays a screen that shows the available modules.

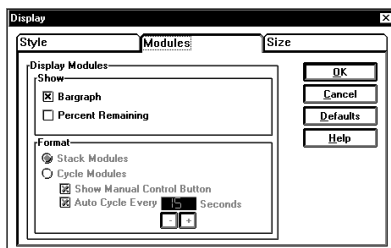

The Modules page

3 Click the check box next to each of the modules you wish to include in the battery gauge.

You may choose any or all of these modules. If you don't choose a module, MaxTime displays the Bargraph module.

4 If you choose to display more than one module, the Format options are activated:

- ❖ Choose Stack Modules to display all selected modules at once.
- ❖ Choose Cycle Modules to cycle between the selected modules.

5 If you choose Cycle Modules, you can choose one or both of the following settings:

- ❖ Click Show Manual Control Button to include a manual control button in the MaxTime window. You can click this button to switch to the next selected module.
- ❖ Click Auto Cycle Every *xx* Seconds to switch to the next selected module every *xx* seconds, where *xx* is a number you set by clicking the + and - buttons.

6 Choose OK to save your changes, exit the dialog box and return to the battery gauge.

The battery gauge now shows the module(s) you selected.

Keeping the Battery Gauge Visible at All Times

When you first open the MaxTime battery gauge, it acts as a normal Windows program. Opening other programs may cover the battery gauge. If you prefer to see the battery gauge at all times, change the Style option in MaxTime.

The Style Option has these values:

- ❖ Normal - sets the battery gauge to act as a normal Windows program. Other programs may display on top of the battery gauge.
- ❖ Always on Top - displays the battery gauge on top of all other Windows programs. This gives you a constant reminder of how long you have before running out of power.
- ❖ On Title Bar - places the battery gauge on the title bar of the active window. This also displays the battery gauge at all times.

To set how the battery gauge displays, follow these steps:

1 Choose Display from the MaxTime Options menu.

MaxTime opens the Display dialog box with the Style page on top.

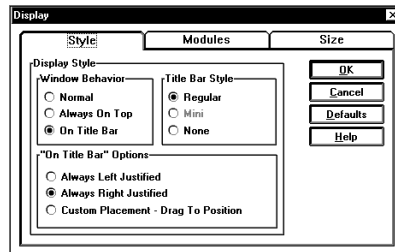

The Display dialog box

2 Click the checkbox next to the setting you want.

If you don't select any of the options, the computer selects Normal.

3 If you choose On Title Bar, the On Title Bar Options become available:

- ❖ Click Always Left Justified to place the MaxTime window at the left side of the title bar of the currently active window.
- ❖ Click Always Right Justified to place the MaxTime window at the right side of the title bar of the currently active window.
- ❖ Click Custom Placement - Drag to Position to choose the placement of the MaxTime window on the title bar of the currently active window.

4 Choose OK to save your changes, exit the dialog box and return to the battery gauge.

MaxTime displays the battery gauge in the way you selected.

What to Do When Your Computer Doesn't Know the Battery Charge

When you insert a fresh battery, your computer may not be able to calculate the battery's charge immediately. In this case, you may want to estimate the battery charge yourself. To do this, follow these steps:

- 1 If MaxTime is open, go to step 4.**
- 2 Click Start, then point to Programs.**
- 3 Point to Toshiba Utilities, then click MaxTime.**

MaxTime displays the battery gauge window.



The MaxTime battery gauge window

- 4 Choose Set Battery Charge from the MaxTime Options menu. This menu item is only available if the system does not know the current battery charge.**

MaxTime opens the Set Battery Charge dialog box.

- 5 Click and drag the slider left or right to set the estimated battery charge.**
- 6 Choose OK to accept your change and exit the dialog box.**

The battery gauge window changes to reflect the charge you set.

What to Do When the Battery Alarm Sounds

Don't panic.

The Satellite 200 Series computer has three alarms, designed to give you sufficient warning before your battery becomes fully discharged. Two of the alarms, the Low Battery Alarm and the Critical Battery Alarm, function only when you're running Windows 95 and MaxTime is open (although MaxTime may be

minimized). The third, the Emergency Battery Alert, operates at all times.

This section describes the three battery alarms, what they mean and how to set each one to fit your personal computing style.

The Low Battery Alarm

If MaxTime is open, it warns you when you're beginning to get low on battery power. MaxTime beeps once and displays the Low Battery Alarm warning. This means you have less than 20% battery capacity remaining. If you've changed the alarm threshold (described in "Setting the Alarms" on page 132), this alarm means you've reached the threshold level you set.

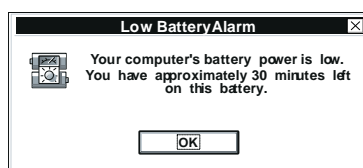

The Low Battery Alarm warning

This warning is just a reminder that the battery charge is a finite resource that can eventually run out. Unless you've told the system to display this message at a really low power level, you don't need to do anything at this point.

To close the Alarm dialog box, choose OK. To change the level of charge that sets off this warning, see "Setting the Alarms" on page 132.

The Critical Battery Alarm

If MaxTime is open, it warns you when you're getting fairly low on battery power. MaxTime beeps once and displays the Critical Battery Alarm warning. This means you have less than 10% battery capacity remaining. If you've changed the alarm threshold (described in "Setting the Alarms" on page 132), this alarm means you've reached the threshold level you set.

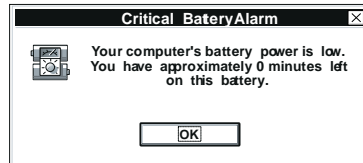

The Critical Battery Alarm warning

When this alarm goes off, start planning your remaining battery time carefully. No frantic actions are required yet, but it's a good idea to begin to think about what you absolutely must do before you find a place to plug in the power cord or turn the computer off.

To close the Alarm dialog box, choose OK. To set the level of charge that sets off this warning, see "Setting the Alarms" on page 132.

The Emergency Battery Alert

OK. Now it's serious. When the battery runs down and you have only about five minutes of time left, the computer starts beeping continuously. If MaxTime is open, it also displays the Emergency Battery Alert.

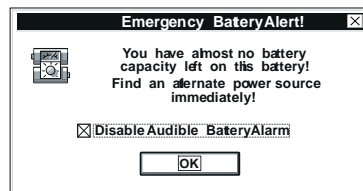

The Emergency Battery Alert

When you reach this point, plug the computer into a live power outlet or save all your files and turn the computer off immediately. Doing this ensures that you won't lose any work and also provides relief to everybody around you who's getting tired of the beeping sound from your computer.

If you don't manage to plug the computer in or turn it off before the battery completely runs out of power, the computer turns off automatically. Don't panic, all is not lost. Before shutting down, the computer automatically turns on Resume Mode (more fully described on page 133). Resume Mode keeps track of where you were so when you turn the power on again you can continue where you left off.

The computer's backup battery stores this information in memory for about eight hours before it too runs out of power.

Setting the Alarms

The Low Battery and Critical Battery alarms sound when the remaining battery charge reaches threshold power levels. The Low Battery Alarm is initially set to 20% of battery capacity. The initial threshold for the Critical Battery Alarm is 10% of battery capacity.

If these threshold levels don't fit your needs, you can use MaxTime to change them. To set the threshold levels for the Low Battery and Critical Battery alarms, follow these steps:

1 Choose Alarms from the MaxTime options menu.

MaxTime displays the Alarms dialog box.

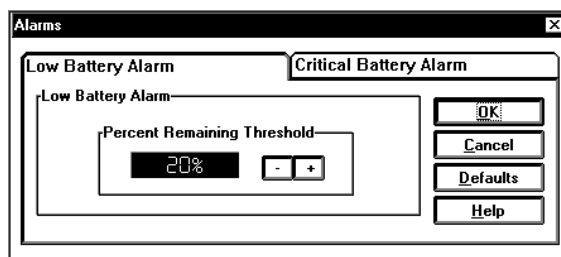

The Alarms dialog box

- 2 Switch to the desired page by clicking the tab for the alarm you want to set.
- 3 To change the Percent Remaining Threshold, click the + or - buttons.

4 Select a Trigger Alarm setting:

To set the alarm to sound when the battery charge reaches the Percent Remaining Threshold, choose Based on Percent Remaining Threshold.

5 Choose OK to save your settings and return to the Max-Time battery gauge window.

Starting Again Where You Left Off

To turn your computer off and on again without all the time it normally takes to start your computer up again, Windows 95's Suspend command and Toshiba's Resume Mode are for you. These modes provide a sort of electronic bookmark, storing the current state of the computer, including all your open files and programs, in memory until you turn the computer on again.

Suspending the computer uses power supplied by the backup battery to store this information. If the backup battery ever discharges completely, your information is lost. What this means to you is that, although suspending will store your open files, you should still save all your work before you turn the computer off.

There are four ways to suspend the computer:

- ❖ Click the Start button, then click Suspend.
- ❖ Use a special key combination (hotkey) to turn on Resume Mode from the keyboard, then turn the computer off by pressing the power button.
- ❖ Use MaxTime to turn on Resume Mode in Windows 95.
- ❖ Use TSETUP to turn on Resume Mode in MS-DOS. TSETUP is described in "TSETUP" on page 341.

The Windows 95 Suspend feature is the easiest way to suspend the computer, however, if you want to use the Panel Power On/Off and System Auto Off options, you must suspend the computer using Toshiba's Resume Mode. These options are described in "MaxTime" on page 311.

The following sections describe how to turn Resume Mode on and off with a hotkey and in MaxTime.

Using a Hotkey

To select Resume Mode with a hotkey, follow these steps:

- 1 Start MaxTime, if it's not already running.**
- 2 Press `Fn + F3` to display the power-up pop-up window.**

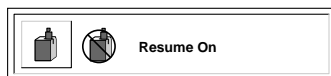

The power-up pop-up window

- 3 While continuing to press `Fn`, press `F3` until the pop-up window indicates Resume On.**
- 4 Release the `Fn` key.**

You're now in Resume Mode.

Using MaxTime

MaxTime lets you select Resume Mode when you're using Windows 95. Follow these steps:

- 1 In the MaxTime battery gauge window, choose Machine Settings from the MaxTime Options menu.**

MaxTime displays the Machine Settings dialog box.

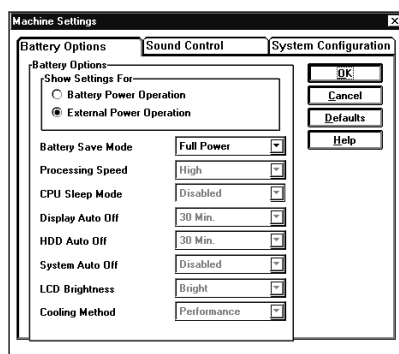

The Machine Settings dialog box

- 2 Switch to the System Configuration page by clicking the System Configuration tab.

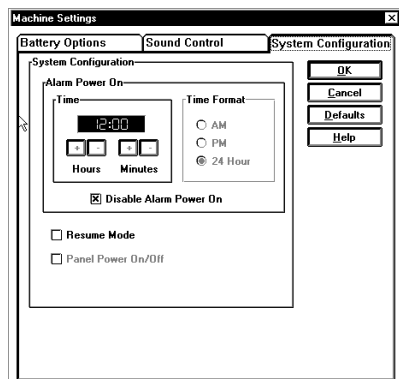

The System Configuration page

- 3 Click the checkbox next to Resume Mode. An X in this box turns Resume Mode on. An empty box turns Resume Mode off.
- 4 Choose OK to save your settings and return to the Max-Time battery gauge window.

Replacing Batteries

When your battery runs out of power, you have two options: plug in the computer or replace the battery with a charged spare, if you have one. You may need to replace the battery if it becomes damaged or wears out after long years of use.



Replacing the battery requires you to open up part of the computer. Be careful when you're following these steps.

To replace the battery, follow these steps:

- 1 Turn the computer off.**
- 2 Turn the computer upside down.**

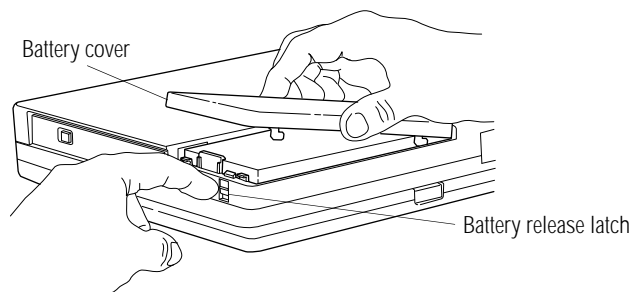

Releasing the battery

- 3 Slide the battery release latch toward the top of the computer and hold it there.**
- 4 Slide the battery cover about 1/2 inch toward the battery release latch.**
- 5 Lift the cover off completely.**

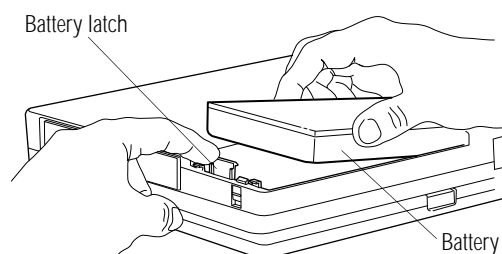

Removing the battery

- 6 With one hand, move the battery latch off the battery.**
- 7 With the other hand, remove the discharged battery from the computer.**
- 8 Wipe the battery terminals of the charged battery with a clean cloth to ensure a good connection.**
- 9 Align the charged battery so the label is down, and the side terminals (the bumpy side) face away from the battery release latch.**
- 10 With the edge of the battery on the latch, press down until the battery drops into place.**
- 11 Place the battery cover over the battery and slide it back into place until it snaps closed.**
- 12 Turn the computer right side up.**

Disposing of Used Batteries Safely

Eventually, after years of faithful service, you'll need to retire each battery and replace it with a new one. Under federal, state and local laws, it may be illegal to dispose of old batteries by placing them in the trash.

The materials that came with your computer may include an insert regarding the disposal of batteries. If not, check with your local government for information on where to recycle or dispose of old batteries.

If you cannot find the information you need, contact Toshiba for assistance. See “Contacting Toshiba” on page 297 for information on contacting Toshiba offices around the world.

Conserving Power

It's a fact: if you're running your computer on battery power, your battery will eventually discharge. However, by using Toshiba's power-saving options, you can greatly increase the amount of time before you need to recharge the battery.

These options have been combined into preset battery save modes. Using one of these modes lets you choose between maximum power savings and peak system performance. You may also set individual power-saving options to suit your own needs.

The following sections describe how to choose a battery save mode and discuss each power-saving option.

The Easy Way—Choosing a Battery Save Mode

There are two battery save modes:

- ❖ Full power provides maximum system performance, while using the most power.
- ❖ Low power decreases battery use by reducing overall system performance.

The following table shows the battery save option settings for both battery save modes:

| <i>Battery Save Options</i> | <i>Full Power</i> | <i>Low Power</i> |
|-----------------------------|-------------------|------------------|
| Processing Speed | High | Low |
| CPU Sleep Mode | Disabled | Enabled |
| Display Auto Off | Disabled | 3 Min. |
| HDD Auto Off | 30 Min. | 3 Min. |
| System Auto Off | Disabled | 30 Min |
| LCD Brightness | Bright | Semi-Bright |
| Cooling Method | Performance | Quiet |

There is also a User Setting that lets you set the power-saving options individually.

You may set the battery save mode with a hotkey, in MaxTime (if you're working in Windows 95) or in TSETUP (if you're working in MS-DOS). This chapter covers setting the battery save mode with a hotkey and in MaxTime. Using TSETUP to set the battery save mode is discussed in "TSETUP" on page 341.

Using a Hotkey

To select a battery save mode with a hotkey, follow these steps:

- 1 Start MaxTime, if it's not already running.**
- 2 Press Fn + F2 to display the battery save pop-up window.**



The battery save pop-up window

- 3 While continuing to press Fn, press F2 until you select the desired battery save mode.**
- 4 Release the Fn key.**

You're now in the selected mode.

Using MaxTime

To select a battery save mode in MaxTime, follow these steps:

- 1 In the MaxTime battery gauge window, choose Machine Settings from the MaxTime Options menu.**

MaxTime displays the Machine Settings dialog box, with the Battery Options page on top.

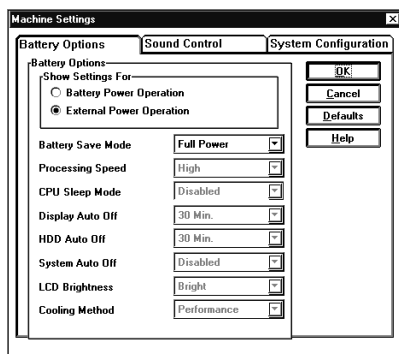

The Machine Settings dialog box

2 In the Show Settings For box, choose Battery Power or External Power.

Your computer has two sets of battery settings. One sets how the system works under battery power. The other sets how the computer works when it's connected to a power outlet.

3 Click the arrow next to the Battery Save Mode option list box to view the available settings.

4 Click the desired setting to highlight it.

5 Choose OK to save your settings and return to the Max-Time battery gauge window.

Setting Your Own Battery Save Options

If you set the battery save mode to User Settings, you can set your computer's power-saving options individually. For example, if you want the computer's processing speed set to its maximum level but want to take advantage of all the other power-saving features, this is the way to do it.

This section describes each of the power-saving options. Settings that save power are indicated with an Energy Star logo.

Processing Speed

This option sets the speed at which the computer processes information. You have two choices:



Low sets a lower processing speed and saves power.

High sets the computer to its maximum processing speed.

CPU Sleep Mode

This option temporarily shuts down the computer's central processing unit (CPU) when it is inactive. Pressing a key, moving the AccuPoint or a signal from a device returns the processor to its normal operating speed. You have two choices:



Enabled turns CPU Sleep Mode on.

Disabled turns CPU Sleep Mode off.

Display Auto Off

This option saves power by temporarily shutting down the display if you have not used the keyboard or AccuPoint for a selected period of time. To turn the display back on, press a key or move the AccuPoint. You have eight choices:

Disabled turns the option off.



1 Min, 3 Min, 5 Min, 10 Min, 15 Min, 20 Min and 30 Min selections blank the display if you haven't used the keyboard or AccuPoint for the selected amount of time.

If you're using an external monitor, Display Auto Off blanks the monitor after the selected time.

HDD Auto Off

This option saves power by temporarily shutting down the hard disk if it hasn't been accessed for a set period of time. The drive turns back on the next time the computer reads from or writes to it. You have seven choices:



1 Min, 3 Min, 5 Min, 10 Min, 15 Min, 20 Min and 30 Min selections turn the hard disk drive off if the computer hasn't accessed the hard disk for the time selected.

System Auto Off

This option saves power by turning the computer off if it hasn't been used for a selected period of time. This option is available only if Resume Mode is turned on. You have seven choices:

Disabled leaves the computer on until you use the power button to turn it off.



10 Min, 20 Min, 30 Min, 40 Min, 50 Min and 60 Min selections turn the computer off if you haven't used it for the time selected.

LCD Brightness

This option saves power by reducing the brightness of the computer's display. You have two choices:



Semi-bright reduces the brightness of the display.

Bright sets the display to its maximum brightness.

Cooling Method

If the computer's central processing unit (CPU) starts to overheat, the CPU fan provides additional cooling to the CPU. This option lets you control how active the CPU fan is in cooling the processor chip.

Performance option uses the fan to cool the processor chip, maintaining maximum system performance. If the fan turns on frequently, you may want to set this option to **Quiet** to conserve battery life.



Quiet cools the system by reducing processing speed first. If the system remains too hot, the system turns on Resume Mode and shuts down automatically.

Looking After Your Battery

It doesn't take much effort, but by treating your battery right you can make sure it provides maximum power storage for a long time. The following sections offer tips on how to take care of your battery.

Five Steps to a Happy Battery

- ❖ Don't leave the computer plugged in and unused for more than a week at a time. If you're not going to use the computer for a long period, disconnect the power cord and let the battery discharge completely.
- ❖ Alternate between batteries if you have a spare.
- ❖ Don't touch the metal terminals on the battery with another metal object.
- ❖ Always turn your computer off when you're replacing the battery.
- ❖ Follow the steps in the next section to maintain your battery's maximum potential.

Maximizing Your Battery's Potential

Over time, the amount of charge your battery can store may decrease. If you notice a your battery charge doesn't last as long as it used to, or as a monthly maintenance routine, follow these steps:

- 1 Set the battery save mode to Full Power by following the steps in “Conserving Power” on page 138.**
- 2 Turn the computer off.**
- 3 Disconnect the power plug.**
- 4 Turn the computer on and leave it on until the battery completely discharges and the system automatically shuts down.**
- 5 Remove the battery and wait 30 seconds.**

- 6 Reinsert the battery.
- 7 Connect the power plug and leave the computer off until the battery is fully charged (approximately two and a half hours).

The battery light glows green when the battery is fully charged.

Additional Power Options

Depending on the amount of time you spend away from external power sources, the capacity of one battery pack may be sufficient for your needs. However, if you need more portable power, Toshiba provides two options:

- ❖ You can buy extra battery packs.
- ❖ You can buy a battery charger that charges more than one battery at a time.

Additional Battery Packs Extend Battery Time

Having one or more extra batteries gives you the opportunity to replace a discharged battery with a charged spare. This can greatly increase the amount of time you can work without having to find a power outlet.

Charging More than One Battery at a Time

The optional battery charger provides an alternative to charging the battery in your computer. This is especially useful if you have one or more extra batteries. You can charge up to two spares at a time in the battery charger while continuing to work on the computer. While the battery charger requires a power source, it provides an easy way for you to take more than one charged battery with you when you travel.



Don't leave batteries in the battery charger for more than a week at a time. Doing so may reduce the potential charge of the battery.

Charging the Computer's Battery in Your Car

The optional automobile power adapter lets you plug the computer into the cigarette lighter of your car. This is a great way to charge the computer's battery while driving to your next appointment.

How about a Carrying Case?

When you're on the road, you'll probably want a way to carry your computer with you. Toshiba offers four choices of carrying cases for the Satellite 200 Series computer:

- ❖ a sturdy fabric carrying case
- ❖ a leather attaché
- ❖ a leather Executive Portfolio
- ❖ a backpack-style case

All of these cases help protect the computer from the bumps and bruises of normal travel. They also provide plenty of extra space for manuals, power cords and diskettes.

Leave the Manual at Home

While you're packing for a trip, you think how nice it would be to be able to leave this heavy manual at home. Fortunately, you can do that without giving up the information you may need.

The entire contents of this manual are available in electronic form on your computer's hard disk. For complete information about using this on-line documentation, see "Using The Electronic Guide" on page 40.

The Wide World of Multimedia

You've heard of multimedia, but what is it? The term *multimedia* refers to the use of two or more communications media (such as text, graphics, sound, animation, and video) to present ideas. A multimedia *title* is the computer presentation of two or more media elements that are experienced simultaneously. You may purchase a multimedia title on compact disc or access one over the Internet.

Unlike television programs or audio tapes, multimedia titles allow you to interact with the information by choosing what to view or listen to and when to see it or hear it.

Your computer has everything you need to enjoy multimedia: a CD-ROM drive, a high-speed Pentium processor, a color display, and advanced sound capabilities.

This chapter introduces the multimedia elements you can explore with the CD-ROM supplied with the Satellite 200 Series. Without investing in additional hardware or software, you can, for example, capture a video and keep track of your compact discs.

In addition to the information provided in this chapter, you may wish to read any of the several excellent books that explain multimedia concepts and procedures in detail.

Building Your Compact Disc Library

The information available on compact discs is extensive. Some current examples are:

- ❖ audio CDs with music
- ❖ instructional CDs with full motion video
- ❖ data base CDs with medical books, telephone books, cook-books and other extensive reference material.
- ❖ searchable texts of books, stories, poems, the Bible and other literature
- ❖ adventure games, fantasy games and simulations
- ❖ children's stories and learning games
- ❖ multimedia presentations
- ❖ photo CDs with your own electronic photographs
- ❖ CDs filled with clip art files
- ❖ CDs with computer programs to help you redesign your home or garden, plan your vacation, balance your budget, chart your stars or raise your child
- ❖ extensive catalogs of hobbies such as coin collections, astronomical references, and fishing lures
- ❖ data bases with census data, financial records, maps and charts

You will want to collect a library of compact discs to help you at work, at home, in study or recreation.

Playing a Pre-installed Compact Disc

For each installed compact disc title, the hard disk holds a small program that displays the title's icon. It does not store the title's content. To view a compact disc:

- 1 Place the disc in the CD-ROM drive.**
- 2 Click Start, then point to Programs.**
- 3 Locate the folder that contains the compact disc icon and title.**
- 4 Double-click the icon.**

If you double-click the icon and the compact disc isn't in the CD-ROM drive, Windows 95 prompts you to insert the disc.

Adding New Titles

When you buy a new compact disc, always run the installation program that comes with the disc. This program installs the icon that will access the contents of the compact disc.

For information about managing CD-ROM titles, see "Managing Your CD-ROMs" on page 160.

Playing an Audio CD

When you insert an audio CD into your computer's CD-ROM drive, Windows 95 loads CD Player, a program that automatically plays the CD. To view the CD Player window, click CD Player on the taskbar.



The CD Player window

To adjust the volume, turn the volume control dial on the front of the computer.

To stop the CD, click the stop button.

To eject a CD, click the eject button in the CD Player window, or press the CD-ROM eject button on the right side of the computer.

If Windows 95 didn't start CD Player automatically when you inserted the audio CD, follow these steps to start it now:

1 Double-click the My Computer icon.

Windows 95 opens the My Computer window.

2 Click the Audio CD icon with the secondary button.

3 Click Play.

Windows 95 opens the CD Player and starts playing your audio compact disc.

Playing Back Sound, Video and Animation Files

Multimedia files are stored in a variety of formats depending on the type of file.

Sound Files

Traditionally, sound is recorded in an analog form. For example, a magnetic tape recorder uses electrical signals to create a single model of a given sound or *waveform*.

Most multimedia computers support two types of sound files, wave files and MIDI files.

Digital Audio Wave Files

Digital audio uses computer-based technology to record, handle and recreate sound. Digital audio systems sample the waveform at fixed time intervals, for example, at 30 times per second, and reduce the sound to a sequence of numbers.

When you play back a digital waveform or wave file, the software transforms the numeric data back into its original acoustic waveform.

If you use the microphone to record sounds, the computer stores them as wave files.

Wave files have the extension .WAV.

MIDI Files

Musical Instrument Digital Interface (MIDI) is a standard language used by composers to create music to be played by a synthesizer. MIDI songs consist of commands, not actual digital sounds. For this reason, the size of a MIDI file is much smaller than a .WAV file.

You can connect an external MIDI device, such as a keyboard with a built-in synthesizer, or you can play MIDI files using the computer's internal synthesizer.

To learn more about the system's MIDI capabilities, look up MIDI in the Windows 95 Help index.

MIDI files have the extension .MID.

Video and Animation Files

Full-motion video includes both traditional film and animation. A video plays back on your VCR at 30 frames per second. To play back the same video on your computer would require 9 megabytes of data per second at 640 by 480 resolution.

Since playing back video requires so much data, multimedia applications that use film or animation normally play back at 15 frames per second with a resolution of 320 by 200 pixels. This is why the

video on a computer is not as smooth as what you are used to seeing on television.

To reduce the storage required, all video files must be compressed before they can be distributed and decompressed when you view them. Two compression and decompression techniques are in general use.

AVI Files

The most common technique for storing and playing back video on personal computers is Microsoft's Audio Video Interleaved (AVI) format. This software technique displays video using up to 15 frames per second in a small window.

AVI files have the extension .AVI.



DEFINITION

A frame is a still picture that, when combined with thousands of others, makes a motion picture.

Full-motion video means motion pictures played back at 30 frames per second.

Interleaving video is the process of displaying every other row of pixels each time the computer refreshes the screen. This increases the rate at which the system updates the screen.

A pixel is the smallest dot on your screen that can be controlled by software.

Resolution is the number of pixels on the screen.

MPEG Files

Fifteen frames per second is not adequate for the games and multimedia titles the industry wants to produce. The Motion Picture Expert Group (MPEG) has developed compression and decompression standards that are capable of delivering true full-motion video on your computer. MPEG files have the extension .MPG.

Full-Motion Video on the Satellite 200 Series Computer

For best results, MPEG requires specialized hardware to bypass the computer's Central Processing Unit (CPU) and system bus (the backbone of the computer to which all internal devices are connected).

Your computer's PC Card slots are Zoomed Video (ZV) compatible. ZV PC Cards conform to the new Zoomed Video standard and provide such services as video capture and the decompression of MPEG-compressed multimedia data (audio and video). To capture video, you need to purchase a ZV PC Card and insert it into the Type II PC Card slot on your computer. Toshiba sells a ZV PC Card, which may be available from your dealer.

Audio and video data flow from the hard disk, a compact disc, the Internet or another source across the system bus to the PC Card controller. The controller passes them to the MPEG decoder on the PC Card, which delivers uncompressed video data back to the PC Card controller.

The PC Card controller then sends a decompressed video stream directly to the video/graphics controller, which displays it on your screen. It sends decompressed audio data directly to the audio sound chip, which controls the speakers.

By bypassing the CPU and system bus, a ZV PC Card can deliver high-performance video data at 30 frames per second.

Play Back Programs

Windows 95 comes with three programs for playing multimedia files:

- ❖ CD Player is used to play an audio CD. The section "Playing an Audio CD" on page 149 explains how to use this program.
- ❖ Media Player is used to play back audio, video and animation files.
- ❖ Volume Control lets you adjust the volume.

Using Media Player

You can use Media Player to play back wave and Video for Windows files in addition to playing back several other formats such as MIDI and Quick Time for Windows files.

To play a file, follow these steps:

- 1 **Click Start and point to Programs.**
- 2 **Point to Accessories, then point to Multimedia.**
- 3 **Click Media Player.**

Windows 95 displays the Media Player window.

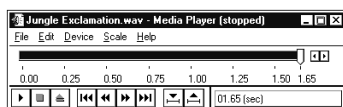

Media Player ready to play a wave file

- 4 **Choose Open from the File menu.**
- 5 **Locate the file you want to play in the Look in box.**
- 6 **To display the list of file types Media Player can play, click the down arrow next to the Files of type list box.**
- 7 **Click the name of the file you want to play.**



HINT

Another way to play a multimedia file is to click on the file name with the secondary button. This opens a list that includes the Play command.

Adjusting the Volume

You can change the volume in two ways:

- ❖ by using the Volume Control program
- ❖ by turning the volume control dial on the front of the computer

The Volume Control program sets the volume and balance for both CDs and multimedia files that contain sound.

To access this program, follow these steps.

- 1 Click Start and point to Programs.
- 2 Point to Accessories, then point to Multimedia.
- 3 Click Volume Control.

Windows 95 displays the Volume Control mixer window.

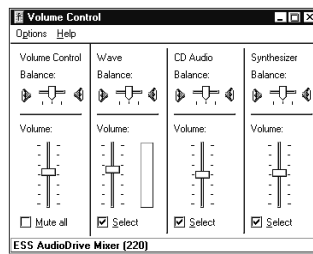

The Volume Control mixer window

- 4 Move the sliders to adjust the volume for the various types of sound files.



NOTE

To avoid confusion, set all the mixer sliders in the Volume Control program to their medium settings and adjust the volume with the volume control dial.

Recording Sounds as Wave Files

You may record sounds using the built-in microphone, an external microphone, the built-in CD-ROM drive or, using the line-in jack, from an outside source, such as your stereo system. This section describes how to record sounds.

Using the Built-In Microphone

The easiest way to record is through the computer's built-in microphone. To do this, follow these steps:

- 1 **Click Start, then point to Programs.**
- 2 **Point to Accessories, then point to Multimedia.**
- 3 **Click Sound Recorder.**

Windows 95 opens the Sound Recorder window.



- 4 **Click the record button.**

It's the red circle at the bottom right of the window.

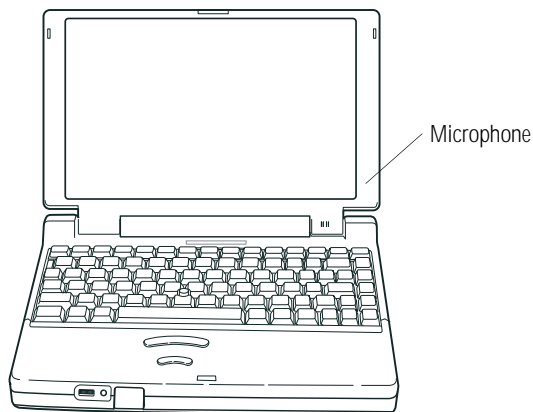

Locating the built-in microphone

- 5 **Speak normally into the microphone.**
- 6 **When you've finished recording, click the stop button.**



The Sound Recorder window displays a waveform display of the new sound file.



- 7 **To hear what you just recorded, click the play button.**
- 8 **To save the file, choose Save from the File menu.**

Using an External Microphone

The computer has a built-in microphone for recording sounds. To record higher quality sounds, you may wish to use an external monaural microphone. To attach an external monaural microphone, follow these steps:

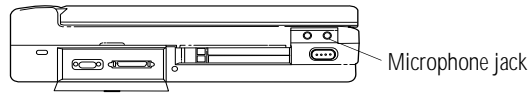

The microphone jack

- 1 Locate the microphone jack on the left side of the computer.**
- 2 Plug the microphone cord into the microphone jack.**
- 3 Turn the microphone on.**

The built-in microphone is automatically disabled.

Once the external microphone is connected, the recording process is the same as for the built-in microphone. See “Using the Built-In Microphone” on page 156 for instructions. To adjust the quality of the recording, see “Adjusting Recording Quality” on page 159.

Recording from the Computer’s CD-ROM Drive

To record from an audio compact disc, follow these steps:

- 1 Insert the audio CD from which you wish to record into the computer’s CD-ROM drive.**

Windows 95 starts the CD Player program automatically.

- 2 Click Start, then point to Programs.**
- 3 Point to Accessories, then point to Multimedia.**
- 4 Click Volume Control.**

Windows 95 displays the Volume Control mixer window.

- 5 Click View, then click Volume Control.**

The CD Player opens the Volume Control window.

6 Choose Properties from the Options menu.

7 In the Properties dialog box, click the button next to Recording.

You can choose from four volume controls:

- ❖ Synth
- ❖ Line
- ❖ MixOut
- ❖ Mic

8 Make sure the box next to MixOut is selected (checked).

9 Click OK.

This leaves the mixer open on the desktop with the recording controls displayed.

10 In the MixOut section of the window, select the check box next to Select.

There should be a check mark in the check box.

11 Click Start, then point to Programs.

12 Point to Accessories, then point to Multimedia.

13 Click Sound Recorder.

Windows 95 opens the Sound Recorder program.

14 With the audio CD playing, click the record button on the Sound Recorder.

15 When you've finished recording, click the stop button on the Sound Recorder.

Using an External Audio Input Device

To record sounds from an external audio device, such as a stereo amplifier, tape deck, or CD player, follow these steps:



The line-in jack

- 1 Locate the line-in jack on the left side of the computer.**
- 2 Using any necessary adapters, plug the cord from the audio device into the line-in jack.**

Once an external audio device is connected, the recording process is the same as for the built-in microphone. See “Using the Built-In Microphone” on page 156 for instructions. To adjust the quality of the recording, see “Adjusting Recording Quality” on page 159.

Adjusting Recording Quality

You can adjust the quality of your recordings. However, the better the quality of the recording, the more disk space the sound file will require. Experiment a bit to find a balance that fits your needs.

To adjust the recording quality, follow these steps:

- 1 If you already have the Sound Recorder open, skip to step 5.**
- 2 Click Start, then point to Programs.**
- 3 Point to Accessories, then point to Multimedia.**
- 4 Click Sound Recorder.**

Windows 95 opens the Sound Recorder window.

- 5 Click Edit, then click Audio Properties.**

Sound Recorder opens the Audio Properties sheet.

6 Adjust the Recording Volume, Preferred device, and Preferred quality according to your needs.

7 Click OK.

Your new settings will take effect the next time you record.

Using External Speakers or Headphones

To play back sound files through an external device such as headphones or stereo speakers, follow these steps:

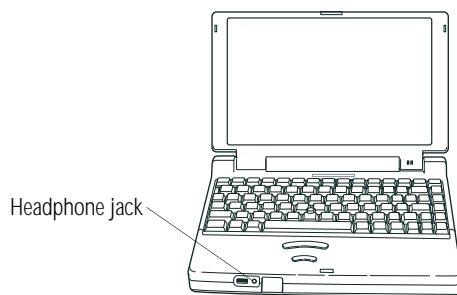

The headphone jack

- 1 Locate the headphone jack on the front of the computer.**
- 2 Plug the cord from the external audio device into the headphone jack.**

The headphone jack requires a 16-ohm stereo mini-jack. If your device uses a different jack, you can purchase an adapter at most electronics stores.

- 3 Follow the steps in the previous section.**

Managing Your CD-ROMs

If you have a large number of CD-ROMs, you might find yourself wishing for an easy way to keep track of what's on all of them. That's where Toshiba's magiCDisc CD-ROM management program comes in.

With magiCDisc, you can launch an associated program whenever you insert a CD-ROM into the drive. You can search for a specific CD-ROM by title, category or other key word, and look at only CD-ROMs of a particular type, such as data, audio or photo. If a CD-ROM includes programs to install on your hard disk, you can start the installation program from magiCDisc. You can also use magiCDisc to browse through and sample the multimedia files (sound, animation and graphical images) on a CD-ROM.



NOTE

To use magiCDisc, you must have the CD-ROM drive installed in the SelectBay.

Opening magiCDisc

To open magiCDisc, follow these steps:

- 1 Click **Start**, then point to **Programs**.
- 2 Point to **magiCDisc**.
- 3 Click **magiCDisc**.

There are two primary screens in magiCDisc. The main screen is shown in the following illustration. The other is the CD Rack, which contains a list of your CD-ROMs. The CD Rack is described in “Looking at a List of CD-ROMs” on page 164.

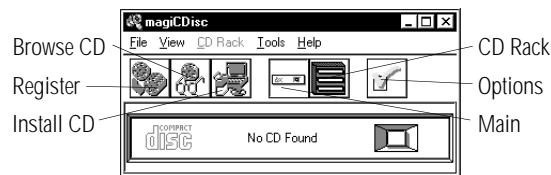

The main screen

From here, you may perform a number of tasks:

- ❖ You can add the CD-ROM to your list by choosing the **Register button**. See “Adding a CD-ROM to the List” on page 162.

- ❖ You can look through the files on the CD-ROM and play one or more of them by choosing the **Browse CD button**. See “Looking at and Playing the Files on a CD-ROM” on page 166.
- ❖ If the CD-ROM contains files that need to be installed on your hard disk, you can start the installation process by choosing the **Install CD button**. See “Installing Programs from a CD-ROM” on page 168.
- ❖ You can view your list of CD-ROMs by choosing the **CD Rack button**. See “Looking at a List of CD-ROMs” on page 164.
- ❖ You can customize magiCDisc by choosing the **Options button**. See “Changing How magiCDisc Operates” on page 168.

Inserting a New CD-ROM

The first time you insert a CD-ROM into the drive, magiCDisc displays the Inspector dialog box.

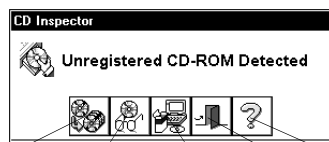

Register Browse CD Install CD Close Help

The Inspector dialog box

This dialog box informs you that you have not previously registered the current CD-ROM. It also includes magiCDisc tools that let you register, browse or install the CD-ROM. This dialog box opens automatically, relieving you of the need to remember whether a CD-ROM is registered or not.

Adding a CD-ROM to the List

To add a CD-ROM to your list, follow these steps:



- 1 **Click the Register button in the Inspector dialog box or from the magiCDisc toolbar.**

The New Registration dialog box opens.

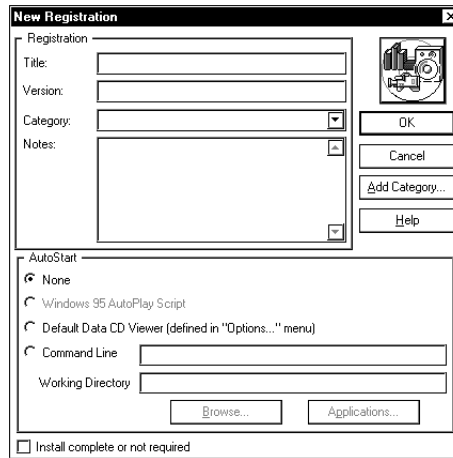

The New Registration dialog box

There are three types of CD-ROMs: data, audio and photo. The system determines the type of your CD-ROM, and displays the appropriate icon in the upper right corner. The previous illustration shows the New Registration dialog box for a data CD-ROM.

The options in the dialog box are different depending on the CD-ROM type.

- 2 Enter a title and version (data CD), artist (audio CD) or date (photo CD).**
- 3 Use the Category drop-down list box to enter a category.**
To add a new category, click the Add Category button.
- 4 Type in any additional information in the Notes box.**
- 5 Select None if you don't want the system to start a program automatically when you insert the CD-ROM.**

Select Windows 95 AutoPlay Script to run the associated AutoPlay script file on the CD-ROM when you insert the CD-ROM. This option is only available if the CD-ROM being registered supports the Windows 95 AutoPlay script capability.

Select Default Media Player to start the player appropriate for the type of CD-ROM when you insert the CD-ROM into the drive. Using this option lets you set the media player for all CD-ROMs of a specific type. To define the player, see “Customizing the Media Player” on page 170.

Select Command Line to start a specific program when you insert the CD-ROM into the drive. Enter the exact command and working directory into the indicated boxes or use the Browse or Applications buttons to locate the program.

6 Click OK to complete the registration process and close the New Registration dialog box.

That’s all there is to it. The next time you look at the rack screen, your new CD-ROM will appear in the list (unless you’ve set the rack screen to display only CDs of a different type).

Looking at a List of CD-ROMs



To examine a list of your registered CD-ROMs, click the CD Rack button on the main screen. The rack screen opens. You may look at all the registered CD-ROMs, or only those that meet certain criteria. To set these criteria, see “Locating a CD-ROM” on page 165.

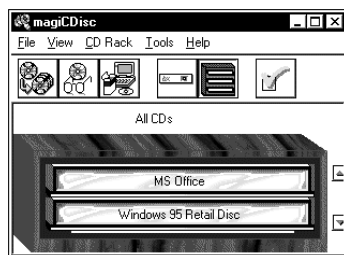

The rack screen

The lower portion of this screen shows a list of registered CD-ROMs that meet the criteria you’ve entered.

The toolbar buttons are the same as those on the main screen. However, the Register, Browse and Install buttons have no effect

unless you select a CD-ROM from the list. See the next section for details.

Selecting a CD-ROM from the List

To select a CD-ROM from the list, click it. Once an item is selected, you can:



- ❖ modify the registration information for the CD-ROM by choosing the Register button. You can change this information at any time. See “Adding a CD-ROM to the List” on page 162.



- ❖ browse through multimedia and data files on the CD-ROM and play one or more of them by choosing the Browse button. You cannot browse an audio CD-ROM. You can only browse the CD-ROM you selected in the rack if it is the same as the one in the drive. See “Looking at and Playing the Files on a CD-ROM” on page 166.



- ❖ install the CD-ROM by choosing the Install button. You can only install the CD-ROM you selected in the rack if it is the same as the one in the drive. See “Installing Programs from a CD-ROM” on page 168.

Locating a CD-ROM

If you have a large number of CD-ROMs, you can set the rack to show only one type of CD-ROM, only those CD-ROMs in a particular category or those CD-ROMs whose description contain one or more key words. All of these options are available through the CD Rack menu, as described below:

- ❖ To show all your CD-ROMs, choose Display All CDs from the CD Rack menu.
- ❖ To show only one type of CD-ROM, choose Display *type* CDs only from the CD Rack menu, where *type* is Data, Audio or Photo.
- ❖ To show all the CD-ROMs in one or more categories, choosing Search by Category from the CD Rack menu opens the Search by Category dialog box. Select the desired category or categories from the list and click OK.

- ❖ To display those CD-ROMs whose descriptions use a key word, choosing Search by Text from the CD Rack menu opens the Search for Text dialog box. Enter one or more key words separated by semicolons (;) into this box and click OK.
- ❖ To show all the CD-ROMs of the selected type, (all, data, audio or photo), choose Clear Previous Search.

Looking at and Playing the Files on a CD-ROM

To look through a list of files on a CD-ROM, follow these steps:



1 Click the Browse button.

This button is available in the both the main and rack screens, and the Inspector dialog box. You can only browse the CD-ROM if the CD-ROM selected in the rack is the same as the one in the drive.

The CD-ROM Browser opens.

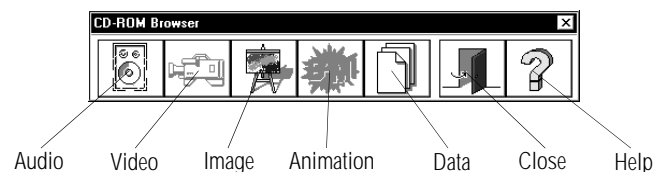

The initial CD-ROM Browser

2 Click the Audio, Video, Image, Animation or Data button to search for files of a particular type.

The extended CD-ROM Browser opens.

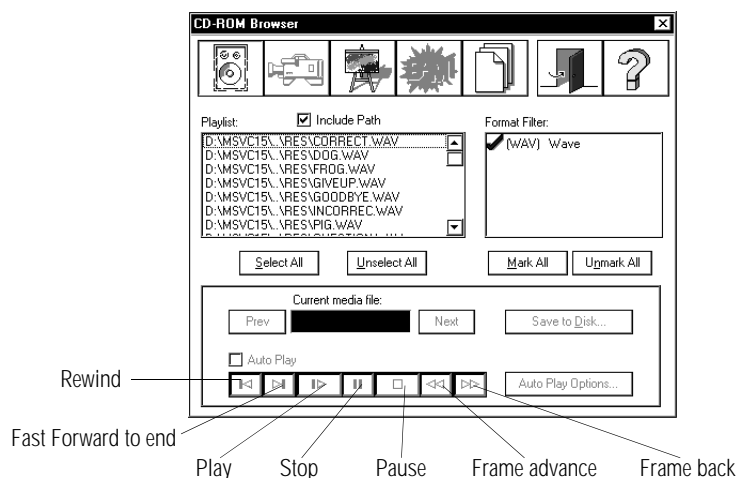

The CD-ROM Browser

3 Select one or more files in the playlist.

To select more than one file, press Ctrl as you click files beyond the first. To select several adjacent files, press Shift when you click the second file.

4 Click the Play button to play the file.

Choosing the Next and Previous buttons moves you forward and backward through the selected files in the playlist.

To play all the selected files in the playlist, select AutoPlay before choosing the Play button. Click the AutoPlay Options button to set how the multiple files play. For example, you can set magiCDisc to limit the play time for each file.

5 When you've finished playing your files, click the Close button to close the CD-ROM Browser.

Installing Programs from a CD-ROM



Many CD-ROMs have programs that you must install onto the hard disk. To install these files through magiCDisc, click the Install CD icon on the toolbar. The magiCDisc program searches for the CD-ROM's installation program and lets you start it. If there is more than one installation program, magiCDisc offers you a choice between them.

Changing How magiCDisc Operates

So far, you've seen how to manage your CD-ROMs with all of magiCDisc's settings set to their original values. However, you can customize many features of magiCDisc to fit your needs.

Customizing the Inspector

To customize how the Inspector operates, follow these steps:



1 Click the Options button from the main or rack screen.

The Registration Options dialog box displays with the CD Inspector page selected.

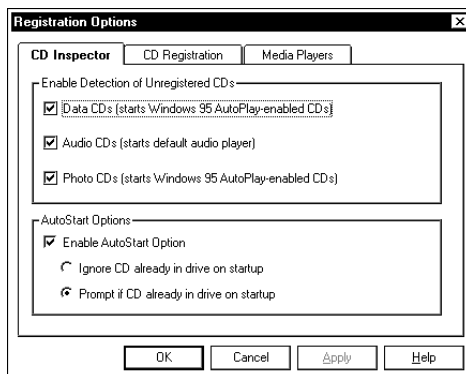

The CD Inspector page

- 2 To enable the Inspector for unregistered CD-ROMs, click the checkbox next to each desired type.**

If the unregistered CD-ROM contains a Windows 95 AutoPlay script, the Inspector executes the script. If no Windows 95 AutoPlay script is found on the CD-ROM, the Inspector dialog box opens.

If the disc is an unregistered audio CD-ROM, the Inspector launches the default audio player.

- 3 To automatically start programs when you insert a registered CD-ROM, click the box next to Enable AutoStart Option. A check appears in the box when the option is enabled.**



If this option isn't set, registered CD-ROMs won't start programs automatically, even if the AutoStart option is selected in the individual CD-ROM's registration information.

- 4 Click OK to close the Registration Options dialog box with your settings in effect.**

Customizing CD-ROM Registration

To customize the registration process, follow these steps:



- 1 Click the Options button on the main or rack screen.**

The Registration Options dialog box displays with the CD Inspector page selected.

- 2 Click the CD Registration tab to move to the CD Registration page.**

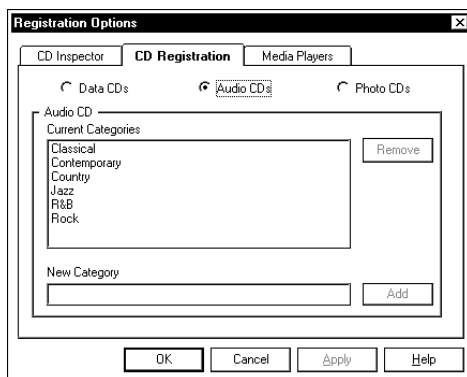

The CD Registration page

- 3 Choose one type of CD-ROM to display the current categories for that type.**
- 4 Change the list of categories as necessary:**
 - ❖ to remove a category, select it and click the Remove button.
 - ❖ to add a category, click the Add Category button.
- 5 Click OK to close the Registration Options dialog box with your settings in effect.**

Customizing the Media Player

Setting a default media player lets you change or upgrade the media player for all CD-ROMs of a specific type, rather than changing the AutoStart settings for each individual CD-ROM.



Setting the default media player only affects an individual CD-ROM if AutoStart is set to Default Media Player in the CD-ROM's registration information.

To set the default media player for each type of CD-ROM, follow these steps:



1 Click the Options button on the main or rack screen.

The Registration Options dialog box displays with the CD Inspector page selected.

2 Click the Media Player tab to move to the Media Player page.

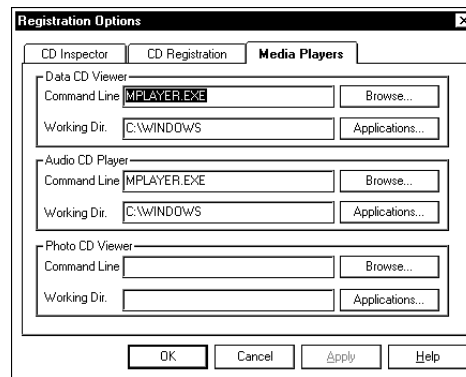

The Media Player page

3 Enter the Application name and Working Directory for the player of each type of CD-ROM (Data, Audio and Photo).

You may use the Browse or Applications buttons to locate and select the desired media player.

4 Click OK to close the Registration Options dialog box with your settings in effect.

Little Cards That Do Big Things

PCMCIA-compatible PC cards greatly increase the capabilities of your computer. These cards pack all the performance of full-sized expansion boards into a case the size of a credit card.

Your computer comes with one PC card slot that lets you take advantage of these little cards. You can install up to two Type I or Type II cards, or one Type III card. Type III cards, such as hard disk drive PC Cards, require extra thickness. When you buy a PC card, check the package for the Type of card you're buying.

Your computer's PC Card slots are Zoomed Video (ZV) Card ready, allowing you to use PC Cards that comply with this standard.

This chapter describes the different types of PC cards, tells you how to install PC cards and provides general tips on using them. Since each card is different, you'll have to read your cards' documentation to use the card, but this chapter will help you get started.

174 Little Cards That Do Big Things

What Do PC Cards Do?



If your PC card came with a diskette, read "Programs that Make Your PC Card Work" on page 175 before installing any of its programs. The programs on the diskette may conflict with the built-in Windows 95 drivers.

What Do PC Cards Do?

New PC cards are being introduced every day. Among the PC cards currently available are:

- ❖ Modems and fax/modems
- ❖ Network adapters
- ❖ Removable hard disk devices
- ❖ Memory
- ❖ SCSI adapters
- ❖ Global Positioning System (GPS) receivers
- ❖ ZV Port cards

Some PC cards combine the functions of several different cards. One popular example is a PC card that combines a network card with a modem. These are handy if you want to get the most out of your PC card slots.



PC card technology has changed considerably over the last few years and it's important that your card is current with the times. Check the package to make sure the PC card you buy conforms to the PCMCIA (Personal Computer Memory Card International Association) 2.1 standard (or later). Cards that do not conform to this standard may work with your computer, but are likely to be much more difficult to set up and use.

Cards You Can Buy From Toshiba

Toshiba's Noteworthy PC cards are specifically designed to work with your Satellite 200 Series computer and are available from your Toshiba dealer. Noteworthy PC cards include:

- ❖ Fax/Modems
- ❖ Removable hard disk drives
- ❖ Token ring network adapters
- ❖ Ethernet network adapters
- ❖ SCSI adapters
- ❖ Global Positioning Systems (GPS)
- ❖ ZV port card for video capture

Programs that Make Your PC Card Work

PC cards require Card and Socket Services software—a set of programs that acts as a translator between the PC card and the computer. These programs makes hot swapping (switching cards while the computer is on) possible.

Windows 95 comes with all the Card and Socket Services programs already installed. Rather than using the programs that may have come with your PC card, use the Windows 95 versions to ensure complete compatibility with all the features of Windows 95.

If you do use another manufacturer's Card and Socket Services software instead, the system may not recognize your PC card when you turn the computer on after suspending. Shut down and restart the computer and the system will recognize the card.

To set up the Card and Socket Services programs for your PC card, see "Setting Up Your PC Card for Your Computer" on page 177.

Hot Swapping

One of the really great things about PC cards is that you can exchange one PC card for another card even while the computer is on. This is called “hot swapping.” For example, if you want to switch between a hard disk and a modem PC card, you can do it while you’re working without turning the computer off and back on again.

Hot Swapping Cautions

While you can insert a PC card at any time, applying a bit of common sense about when you remove a card will make your computing life much happier. Just remember not to remove a card while it’s in use. You probably won’t break anything, but you could lose valuable information. For example:

- ❖ Do not remove a modem card while it is communicating.
- ❖ Do not remove a hard disk card while the system is accessing the card.
- ❖ Do not remove a SCSI card while any of the SCSI devices connected to it are operating.
- ❖ Do not remove a network card while the network drivers are loaded.

Before removing a PC card, stop the card by clicking the PC Card (PCMCIA) icon on the taskbar.

Inserting PC Cards

OK. You’ve bought your first PC card and want to install it. This section describes what to do.



Toshiba provides CardSoft for your PC card installations. Even if your PC card comes with a version of Card and Socket Services, you should use the files included from Toshiba.

You may insert Type I or Type II cards into either the upper or lower socket. You may insert a Type III card into the lower socket only. Inserting a Type III card takes up all the space for both slots—you cannot have a Type III card installed with any other card.

To insert a PC card, follow these steps:

1 Locate the PC card slot on the left side of the computer.

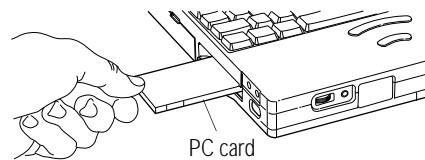

Inserting a Type II PC card into the PC card slot

2 Insert the PC card.

If you have a Type III card, insert the connector into the lower part of the socket. If you have a Type I or Type II card, insert it into either the top or bottom half of the slot.

3 When the card is almost all the way into the slot, push firmly, but gently, to ensure a firm connection with the computer.

When the card is fully seated, an eject button pops out: the top button for the upper slot and the bottom button for the lower slot.

4 Pull the eject button out slightly and fold it down to the left.

Do not force the card into position.

Setting Up Your PC Card for Your Computer

Some PC Cards, such as many fax/modems and hard disk (ATA) cards, are ready to use as soon as you install them. Others, such as network cards and SCSI adapters, require additional steps to set them up to work with your computer.

Setting Up PC Card Support in Windows 95

When you insert your PC Card, Windows 95 attempts to recognize the card automatically. If Windows 95 recognizes the card, there is nothing more you need to do. You are ready to use the card.

Using the Card Wizard

If Windows 95 cannot identify the card, it displays the New Hardware Found dialog box. This dialog box has four options.

| <i>Option</i> | <i>What it means</i> |
|---|---|
| Windows default driver | If Windows 95 has a driver for your card built-in, you should use it. The manual that came with your card should indicate if the driver is built into Windows 95. |
| Driver from disk provided by hardware manufacturer | If a driver diskette came with the card and the manual instructs you to install it, follow the directions in the manual. |
| Do not install a driver (Windows will not prompt you again) | This is really not an option if you want to use the card. If you choose this option you the card won't work. |
| Select from a list of alternative drivers | Some PC Cards can run with a driver other than the one specifically designed for the card. If you choose this option, Windows 95 displays a list of manufacturers and model names (the drivers). Based on the information in the manual that came with the card, try an alternative driver. |

Using the PCMCIA Wizard

If Windows 95 did not detect your card automatically, and using the Card Wizard did not work, follow these steps:

- 1 Click the My Computer icon with the secondary button, then click Properties.**

Windows 95 opens the System Properties sheet.

- 2 Click the Device Manager tab to access the Device Manager page.**

The Device Manager page should list a PCMCIA socket. If it doesn't, refer to the steps under "The system does not recognize your PC Card or PCMCIA socket controller." on page 292 to set up PC card support.

- 3 Click the "+" to the left of the PCMCIA Socket icon in Device Manager.**

Device Manager lists the controller(s).

- 4 The controller icon(s) appears in one of the following ways:**

- ❖ If the icon appears normally, PC card support is set up correctly. Close the System Properties sheet and Control Panel.
- ❖ If there is a red X over the icon, you need to set up the PC card drivers, Continue with the remainder of this section.
- ❖ If there is a yellow exclamation point (!) over the icon, refer to "PC Cards" on page 290 for troubleshooting information.

- 5 Click OK to close the System Properties sheet and return to the Control Panel.**

- 6 Double-click the PC Card (PCMCIA) icon.**

Windows 95 opens the PCMCIA Wizard.

- 7 Follow the instructions on the screen to set up PC card support.**

Removing a PC Card

To remove a PC card, follow these steps:

- 1 Click the PC Card icon on the taskbar.**
- 2 Click Stop .xxx, where xxx is the identifier or name for your PC card.**

Windows 95 displays a message that you may safely remove the card.

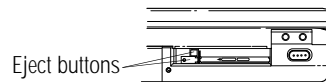

Locating the PC card eject buttons

- 3 If the eject button that corresponds to the slot in which your PC card installed is folded, unfold it and press it to eject the PC card.**

The top button corresponds to the upper slot, the bottom button to the lower slot.

- 4 Grasp the edges of the PC card and slide it out of the slot.**

Depending on the type of card inserted, Windows 95 may need to install additional software. For example, a network card will need to be set up for your network environment.

Connecting to the World

On its own, your Venice 4N Series computer is an extremely powerful tool. However, not until you connect it to one or more additional computers, through a modem, network or cellular connection, can you begin to recognize its full potential.

By using Windows 95's Dial-Up Networking feature and your modem, you can communicate with your office's local-area network (LAN), a larger corporate wide-area network (WAN) or the Internet. For specific information about connecting to a LAN or WAN, consult your network administrator.

This chapter explains how to install and set up a fax/modem and how to fax a document directly from your computer. It describes the many ways you can use your modem to connect to other computers and services, such as the Internet.

If You're Ready to Go

This section provides a brief overview of the steps contained in the remainder of the chapter. If you're an experienced computer user, this may be enough for you. If you need more help, each step tells you where to go for more information. Follow these steps:

1 Install the fax/modem:

You may use a PC Card or an external serial fax/modem. For more information, see "Setting Up" on page 184.

2 Determine the COM port the fax/modem is using.

You'll need to know this to set up your communications program. If you're using a communications program designed for Windows 95, your program may determine the COM port automatically. For more information, see "Determining the COM Port" on page 190.

3 Install the communications program.

This may be a general-purpose communications program or one supplied by a specific service provider. For more information, see "Connecting to a Telephone Line" on page 191.

4 Sign up.

If you're planning to use an on-line service or the Internet, you'll need to register with a provider. For more information, see "Etiquette Online" on page 200.

Setting Up

To communicate with the outside world you'll need:

- ❖ a modem (see the next section for information).
- ❖ a telephone line.

- ❖ a communications program (see “What Software Do You Need?” on page 196. If you’re planning on using an on-line service or the Internet, or if you’re connecting directly to another computer or a bulletin board system (BBS), you’ll need a general purpose communications program, such as the Hyterminal Program included with Windows 95. Refer to “Connecting Directly to Another Computer” on page 205 for information about general communications programs.
- ❖ if you’re planning on using the Internet, you’ll need an Internet service provider (ISP) (see “Etiquette Online” on page 200).

Choosing a Modem

A modem converts the digital signals from a computer into the analog signals required by a voice-grade telephone line. Two types of modems work with your Venice 4N Series computer. You can use either:

- ❖ a PCMCIA-compatible PC Card modem that slips into one of your computer’s PC Card sockets. PC Cards that support the cellular network let you communicate using a cellular telephone.
- ❖ an external modem connected to the computer through the serial port.

Which Modem is for Me?

The right modem for you depends on your work habits and needs. You would use an external modem while in your office, at home or if you wish to keep the two PC Card slots free for other devices. When traveling, a PC Card modem provides a compact way to keep in touch.

Faster is Better

Modems support a variety of speeds from 300 bits per second (bps) to 36.6 kilobits (Kbps) per second (for use on regular telephone lines). In general, you should buy the fastest modem you can afford.

The faster the modem, the quicker you'll be able to send and receive messages, files and information. Transmission speed has a lot to do with how much time you spend connected to the phone line.

Where to Buy a Modem

Toshiba sells PC Card fax/modems specifically designed to work with your computer. Refer to the *Accessories Catalog* for more information on how to purchase one. Your dealer may be able to sell you other fax/modem and fax/voice/modem PC Cards.

Using a PC Card Modem

Once you've purchased your PC Card modem and taken it out of its box, this section describes how to install it and make it ready to use.

Installing a PC Card Modem

If you purchased a PC Card modem, follow these steps:

- 1 Locate the PC Card slot on the left side of the computer.**

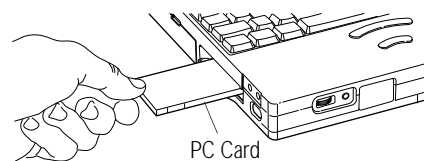

Inserting a Type II PC Card into the PC Card slot

- 2 Insert the modem into either the top or bottom half of the slot.**

If you have a Type III card, insert the connector into the lower part of the socket. If you have a Type I or Type II card, insert it into either the top or bottom half of the slot.

- 3 When the card is almost all the way into the slot, push firmly, but gently, to ensure a firm connection with the computer.**

When the card is fully seated, an eject button pops out: the top button for the upper slot and the bottom button for the lower slot.

- 4 Pull the eject button out slightly and fold it down to the left.**

Do not force the card into position.



NOTE

For more information about using PC Cards, see "Little Cards That Do Big Things" on page 173.

After you've installed the card, connect the telephone cable from the card to the wall jack.

Setting Up a PC Card Modem

When you insert a PC Card modem into the computer, Windows 95 attempts to recognize it automatically and should display a New Hardware Found message.

If Windows 95 can't recognize the card, follow the steps in "Setting Up Your PC Card for Your Computer" on page 177.

Using an External Modem

Once you've purchased your external modem and taken it out of its box, this section describes how to install it and make it ready to use.

Installing an External Modem

To connect an external modem to the computer, follow these steps:

- 1 Turn the computer off.**

Opening the port cover

- 2 Open the port cover on the left side of the computer.**

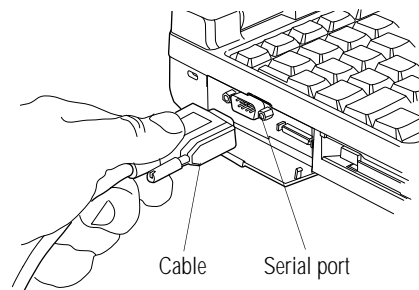

Connecting the cable to the serial port

- 3 Plug one end of the serial cable into the modem and the other end into the computer's serial port.**
- 4 Plug one end of the modem's power cable into the modem and other end into a live wall outlet.**
- 5 Plug one end of the telephone cable into the line out jack on the modem and the other end into the wall jack.**
- 6 Turn the modem's power on.**
- 7 Turn the computer on.**

Setting Up an External Modem

Before you can use your external modem, you must give Windows 95 the information it needs to communicate with your modem successfully. This information includes the model number and manufacturer of your modem. To set up your modem, follow these steps:

1 Click the Start button, point to Settings and click Control Panel.

Windows 95 displays the Control Panel.

2 Double-click the Add New Hardware icon.

Windows 95 opens the Add New Hardware Wizard.

3 Click Next.

The Add New Hardware Wizard asks if it should detect the new hardware for you.

4 Click Yes and then click Next.

Windows 95 displays a message advising you to close all programs.

5 Once you have closed all other programs, click Next to continue.

Windows 95 scans your system for new hardware. If Windows 95 finds your external modem, skip to step 10. If Windows 95 doesn't detect your external modem, click Next to manually install the modem. Windows 95 then displays a list of hardware types.

6 Select Modem and click Next.

The Install New Modem menu opens.

7 To manually install your modem, select Don't detect my modem; I will select it from a list and then click Next.

- 8 Select the manufacturer and model number of your modem. If your modem manufacturer supplied a Windows 95 installation disk, click Have Disk, then click OK. Otherwise, click Next to use the Windows 95 modem drivers.**
- 9 Select the port the modem is connected to (typically COM2), then click Next.**

Windows 95 asks you to enter the dialing information it needs to complete outgoing calls. For example, country code, area code, and any prefix necessary to reach an outside line.

- 10 Enter the dialing information and click Finish.**

Determining the COM Port

Your modem is connected to one of the computer's COM (communications) ports.



Although the terms are often used interchangeably, the serial port and COM port are really two different things. The serial port is the physical port on the left side of the computer. The COM port is a unique identifier the computer uses to communicate with the serial port or other serial devices.

If you're using a Windows 95 communications program, such as Hyperterminal, it determines the COM port automatically. Skip to the following section.

If you are going to install and set up a non-Windows 95 communications program, you must tell it which COM port your modem is using.

To find out which port your modem is connected to, follow these steps:

- 1 Click Start, then point to Settings.**
- 2 Click Control Panel.**

Windows 95 opens the Control Panel.

3 Double-click Modems.

Windows 95 displays the Modem Properties dialog box.

4 Click the Diagnostics tab.

Your modem should be listed next to one of the computer's COM ports.

5 Make a note of the COM port number.

6 To verify that the modem is set up properly, click on the port to which your modem is connected and then click More Info to run the Windows 95 Modem Diagnostics.

Windows 95 communicates with the modem and displays identifying information reported by the modem. If Windows 95 can't communicate with the modem, it displays an error message. Consult the troubleshooting sections of your modem and Windows 95 documentation.

7 Click OK to close the Modem Properties dialog box.

8 Close the Control Panel.

Connecting to a Telephone Line

You need to connect the modem to a voice-grade telephone line with a standard modular phone jack. As the business world becomes more accustomed to busy executives and their portable computing needs, it's becoming much easier to find these jacks. For example, many hotels that cater to business travelers have one or more phone jacks in each room.

Plug one end of the telephone cable into the modem/fax jack and the other end into the wall jack.



If you are using the telephone line at home, disable call waiting before you connect through the modem. Call waiting interrupts transmission.

If you have a modem that is capable of transmitting over the cellular network you can use any cellular line. You need to remain stationary while transmitting data over a cellular phone. Transmitting data while you are moving will cause problems when the cellular network hands off the call to the next cell.

Now that you're set up it's time to communicate. You're ready to send a fax (see the following section) or use the modem to connect to the exciting virtual world of the Internet or an on-line service (see "The Internet and Other Fascinating Places" on page 193).

Faxing a Document

Sending a fax through your computer's fax/modem is almost as simple as printing a document. All you need is a fax program such as MS Fax, which is included with Windows 95.

Windows 95 treats your fax program as if it is another printer. To send a fax:

- 1 Set up your fax/modem, following the steps in "Using a PC Card Modem" on page 186.**
- 2 Choose Print Setup from within the program you're using to prepare your document.**
- 3 Select your fax printer driver from the list of available printers.**

If you're using MS Fax, set the printer to MS Fax. For more information about using MS Fax, refer to the MS Fax on-line Help program.

- 4 Choose Print.**

If you're using MS Fax, it prompts you for a telephone number and gives you an opportunity to attach a standard cover sheet.

Other fax programs will operate in much the same way. If you're using a different fax program, refer to the program's documentation for more information.

- 5 Choose Send to send the fax.**

The Internet and Other Fascinating Places

If you've never used a modem before, you might not realize the vast array of possibilities that await you. You can:

- ❖ Subscribe to an on-line service.
- ❖ Explore the vastness of the Internet.
- ❖ Log on to an electronic Bulletin Board Service (BBS).
- ❖ Communicate directly with another computer that is equipped with a modem, such as one owned by a friend.

The following sections describe each of these options and provide a brief overview of how to access them.

On-line Services

On-line services, such as America Online (AOL) and CompuServe, provide easy access to home shopping, travel arrangements, stock quotes, and forums on a wide variety of topics. You can send e-mail to other subscribers, ask questions on almost any subject, and access a variety of reference materials. Information on most of these services is available through an easy-to-use user interface. Most on-line services also provide complete access to the Internet. Information about the Internet is contained in the following section.

Other on-line services are aimed at a much more specific audience. For example, the Dow Jones Personal Journal delivers an electronic version of the Wall Street Journal, containing only articles that match conditions you set up to suit your interests.

Exploring the World of the Internet



This section contains only a brief overview of the Internet. For more information, look through the books on the Internet that are available at your local book or computer store.

The Internet is a network of computers located all around the world. Information available on the Internet is actually contained on one or more of the member networks. The Internet's origins trace back to the ARPANET, a system created by the U.S. Defense Department. The National Science Foundation (NSF) greatly expanded the system, providing researchers at various sites, such as universities, access to one large body of information.

An on-line service, such as CompuServe or AOL, is operated by a governing corporate body. The Internet, on the other hand, is much more random. No governing body controls who may access its resources or what information may be published on it. Every user is free to contribute and participate without restriction. As more users log on, contributing their own personal styles, the Internet continues to change. The open, international nature of the Internet makes it impossible to regulate or control effectively.

Here are some of the things you can do on the Internet:

- ❖ Search for information on any topic.
- ❖ Send and receive electronic mail (e-mail).
- ❖ Join a written conversation in progress with one or more other people.
- ❖ Shop and do your banking.
- ❖ Get computer programs and other information files.
- ❖ Listen to the radio.
- ❖ Play games with people from around the world.
- ❖ Watch live concerts and interviews.
- ❖ Publish your own articles, books and multimedia works.

On-line Service vs. Internet Service Provider

Deciding which option is best for you may not be easy. Fortunately, you can always change your mind. When making a decision, consider the following:

- ❖ On-line services combine an easy-to-use interface and a wide range of useful services with full Internet access. Each on-line service has a different flavor. Look at advertising material for more than one service to see what each provides. Then decide which service seems most suitable for you.
- ❖ If you don't need the special services offered by an on-line service, logging on to the Internet via an Internet Service Provider (ISP) may be best for you. Because of the enormous size and number of options on the Internet, it can be more difficult to find your way around. If possible, ask a knowledgeable friend to help you.

Some service providers, such as NetCom and Pipeline, provide service to a large area. Others may serve an area as small as a single county. To find out about Internet service providers in your area, check with your computer store, look in computer magazines and local newspapers or ask a friend who's already connected.

What Will it Cost?



NOTE

When you call to sign up to an on-line service or Internet service provider, make sure you have a credit card handy. Even if your service offers an initial free period, your credit card will be billed for use beyond that time.

When you sign up with an Internet service provider or on-line service, make sure you understand the costs involved. Most services charge a monthly rate for a certain number of hours or for unlimited access. An hourly rate applies to additional time on line. If you don't have a local telephone access number, long distance call charges also apply.

Some services charge by the hour. If your service charges by the hour, make sure you know how long you've been on line. It's easy to lose track of time and run up the costs when you're exploring the Internet or an on-line service.

Some services offer both flat and hourly rates.

What Software Do You Need?

To sign up with an on-line service or log on to the Internet directly, you need a suitable communications program.

- ❖ If you're subscribing to an on-line service or an Internet service provider, you need a start-up kit for the service. The start-up kit includes everything you need to set up your account along with the program you use to access the service. It may be supplied free, as an inducement to use that service, or you may need to buy it.
- ❖ If you're using a local Internet service provider, the provider will likely offer or recommend a software package for accessing the Internet.

Types of Internet Services

Each network that belongs to the Internet is a "site" on the Internet. There are different types of Internet sites:

- ❖ A World Wide Web (WWW) site is a place where people can publish their own home pages. Each page has a unique address, in the form of a Universal Resource Locator (URL). You can locate a specific home page by entering its URL or you can click on a hypertext link—indicated by a different color of text or some other obvious means—and jump to the connecting page.
- ❖ Mail servers store and forward electronic mail (e-mail). In many ways, e-mail works like regular mail, but it can be much faster and more convenient.

- ❖ FTP sites store computer files. You can download files from an FTP site. For example, many computer companies distribute minor upgrades to their programs through FTP sites.



When you download a file you transfer the file from another computer (or an FTP site) to your computer.

- ❖ Usenet sites maintain newsgroups, which are lists of messages dedicated to a particular topic. Subscribers to a newsgroup can read and respond to messages posted by others, and post messages of their own.
- ❖ LISTSERV sites administer mailing lists, which are lists of people who are interested in the same topics. Individuals send their message to the centralized LISTSERV site. The LISTSERV server “broadcasts” the message to all the members of the mailing list. This way one person can correspond with lots of people all at once. Mailing lists are different from newsgroups in that you receive all messages automatically.
- ❖ Chat sites allow people to “talk” in real time. Whereas you send your written message to a newsgroup to be read later, in a chat session you type your message and other people in the virtual chat session can respond immediately.
- ❖ Gopher sites provide lists of what is available elsewhere on the Internet. Searching a gopher site is a good way to look for specific information.
- ❖ Telnet sites let you log on to a computer somewhere else in the world and use its resources as if it were on your own local network.

Understanding Internet Addresses

Every Internet user has an e-mail address. A sample e-mail address is:

user@host.subdomain.domain

where:

user is the name you select when you first subscribe to your on-line service or Internet service provider. See “What Software Do You Need?” on page 196 for information about Internet service providers.

host is the server on which your e-mail is located.

subdomain is a local network or computer within the Internet service provider’s system. Many addresses do not include a subdomain.

domain domain indicates the type of host. In the United States, there are six domains:

- com for commercial hosts
- gov for hosts in government institutions
- edu for educational institutions
- mil for military organizations
- net for network and service companies
- org for other organizations

The second type of address is the Universal Resource Locator (URL), used to locate specific sites on the Internet. A sample URL is:

http://aaa.bbb.ccc/dir1/dir2/dir3/page

where:

- | | |
|------------------------|---|
| <i>http://</i> | is the type of server the client is requesting. HTTP stands for Hypertext Transfer Protocol and indicates a site on the WWW. Other server types you might see in a URL include FTP (File Transfer Protocol) and NNTP (Network News Transfer Protocol) |
| <i>aaa.bbb.ccc.dd/</i> | is the host (<i>aaa</i>), optional subdomain (<i>bbb</i>) and domain (<i>ccc</i>) of the server where the information is stored. Country code (<i>dd</i>) is optional and usually indicates a server outside the USA. For example, addresses ending in <i>ca</i> are in Canada. |
| <i>dir1/dir2/dir3</i> | is the folder (directory on the host computer) in which the information is located. |
| <i>page</i> | the name of the page or file. WWW pages usually end in .htm or .html. If no page is specified, the browser displays a file called index.html, which is usually the home page in a WWW site or a list of files in an FTP site. |

Etiquette Online

When you use the internet, it's important to remember that you're dealing with people. You should give other people and "local" customs the same respect on line as you would face-to-face.

Keep the following points in mind:

- ❖ If you're unsure about what might or might not be proper behavior, most newsgroups have a list of FAQs (Frequently Asked Questions). There's also a list of general Internet FAQs on the news.announce.newusers newsgroup.
- ❖ If you're still unsure, read the offerings from others before you post something of your own (this is called "lurking"). This way you can get a feel for what's going on without letting anybody know you're there or making a major social blunder.
- ❖ Whenever you post something on the Internet, include your name and e-mail address. It's a common courtesy to let others know who they're dealing with, and gives them a chance to respond.
- ❖ Be considerate. Just as nobody likes being insulted face-to-face, it's no fun on line either. This isn't to say you can't disagree with anybody on the Internet. A wide variety of differing viewpoints is one of the things that keeps the Internet so vital and alive.

Logging On to an On-line Service or the Internet

This section gives some tips for logging on to an on-line service or the Internet. The basic steps you need to take are as follows:

- ❖ Set up an account with an Internet Service Provider (ISP) or on-line service and obtain your user name and password (for more information see See "Installing TCP/IP Networking" on page 201.).

Request PPP (Point-to-Point Protocol) service, as it is faster and more secure than SLIP (Serial Line Internet Protocol).



If you are connecting to a Local Area Network (LAN) or Wide Area Network (WAN) that has direct Internet access, you may have remote access to the Internet through your network. Ask your network administrator.

- ❖ Install, configure and verify your modem (for more information see “Using a PC Card Modem” on page 186 or “Using an External Modem” on page 187).
- ❖ Add Microsoft’s TCP/IP (Transmission Control Protocol/Internet Protocol) networking protocol to your computer (for more information see “Installing TCP/IP Networking” on page 201).
- ❖ Install Dial-Up Networking and setup your Internet connection (for more information see “Installing Dial-Up Networking” on page 202).

Installing TCP/IP Networking

To set up Microsoft’s TCP/IP networking protocol, follow these steps:

1 Click Start, point to Settings, click Control Panel.

Windows 95 opens the Control Panel.

2 Double-click Network.

3 Click Add.

4 Select Protocol and click Add.

The system will display the Select Network Protocol dialog box.

5 Under Manufacturers, select Microsoft.

6 Select TCP/IP and click OK.

Windows installs TCP/IP on your computer.

- 7 Restart Windows to activate the TCP/IP protocol.**
- 8 To verify that TCP/IP is properly connected to the Windows 95's Dial-Up feature, highlight Dial-Up Adapter in the Network menu and click Properties.**

To get to the Network menu, click Start, point to Settings and click Control Panel.
- 9 Click the Bindings tab and deselect all protocols except TCP/IP.**
- 10 Click OK twice to exit the Network menu.**

Installing Dial-Up Networking

To install Dial-Up Networking, follow these steps:

- 1 Click Start, point to settings, click Control Panel**

Windows 95 displays the Control Panel.
- 2 Double-click Add/Remove Programs.**
- 3 Click the Windows Setup tab.**
- 4 Highlight Communications and click Details.**
- 5 Select Dial-Up Networking and click OK.**
- 6 Click OK to continue.**

Windows 95 adds Dial-Up Networking to your system.
- 7 Click OK to finish and then close the Control Panel.**
- 8 Restart your computer.**

Dial-Up Networking is ready to use. If you have not already installed TCP/IP, do so before restarting the computer.

Setting Up Your Internet Connection

To set up your Internet connection, follow these steps:

- 1 To verify that the computer and modem are connected, click the Start button, point to Settings, click Control Panel then double-click Modems.**

2 Select the Diagnostics tab and click More Info.

Windows 95 should display the name and model of your modem. If it does not display the correct information, you may have to reinstall your modem (see “Using a PC Card Modem” on page 186 or “Using an External Modem” on page 187 for more information).

3 Click OK twice to exit modem diagnostics and then close the Control Panel.

4 Click Start, point to Programs, point to Accessories, and click Dial-Up Networking.

The system opens the Dial-Up Networking Wizard.

5 Click Next to begin the setup.

6 Type a name to identify the location you are calling.

For example, “My Office” if you are calling your office’s local area network (LAN) or “XXX” where XXX is the name of your Internet service provider.

The modem you installed should be listed under Select a Modem.

7 Click Next to continue.

8 Type the telephone number of the network you are calling, including the area code and click Next.

Select the appropriate country code if you are dialing an international number. You can set up additional Dial-Up Networking locations after you have completed the setup for the first location.

9 Click Finish to add the connection to your Dial-Up Networking folder.

10 To set specific connection options, click the connection in the Dial-Up Networking folder, then right-click and select Properties.

De-select Use country code and area code for local calls.

11 Click Server type to select network-specific options

Network options include logon options and protocols. Ask your network administrator or Internet service provider (ISP) for the correct option settings.

12 Click OK twice to exit and then close the Dial-Up Networking folder.

Some Interesting Places to Start

If you're new to the Internet and don't know where to start, this section gives you a few sites you might find interesting.



The Internet is constantly changing. It's possible that one or more of these sites have changed addresses or disappeared altogether.

WWW Sites

- ❖ Toshiba's home pages are:
 - <http://www.toshiba.com> (worldwide Toshiba corporate site)
 - <http://computers.toshiba.com> (marketing and product information in the USA)
 - <http://pcsupport.tais.com> (Product Support in the USA)
 - <http://www.toshiba.ca> (Canada)
 - <http://www.toshiba-tice.com> (Toshiba Europe)
 - <http://www.toshiba.co.jp/> (Japan)
- ❖ <http://river.ihs.gov/> has some great information and pictures about Grand Canyon river running.
- ❖ <http://snow.water.ca.gov/> gives information about the California snow pack.
- ❖ <http://www.irs.ustreas.gov/prod/cover.html> is the site operated by the U.S. Internal Revenue Service.
- ❖ <http://nwsfo.atmos.albany.edu> provides weather-related information.

- ❖ <http://www.epicurious.com/> presents a delicious array of recipes and information on food and drink.

A Few Newsgroups

- ❖ alt.comedy.british is for fans of British humour.
- ❖ alt.sports.badminton lets you keep current with information about badminton.
- ❖ news.newusers.questions is dedicated to information for new users of the Internet.
- ❖ rec.backcountry contains information about outdoor activities, such as backpacking and camping.
- ❖ sci.anthropology provides discussions on anthropology.

Search Engines

- ❖ <http://www.yahoo.com/>
- ❖ <http://www.webcrawler.com/>
- ❖ <http://www.altavista.digital.com/>
- ❖ <http://www.albany.net/allinone/>

Additional Places of Interest

- ❖ president@whitehouse.gov is the e-mail address of the U.S. President.
- ❖ marvel.loc.gov is the gopher for the Library of Congress.

Connecting Directly to Another Computer

If you're connecting directly to another computer or a bulletin board system (BBS), you'll need a general-purpose communications program, such as the Hyperterminal program included with Windows 95. This section describes some of the things you'll need to know to connect to another computer, but does not contain spe-

cific instructions for any communications programs. Refer to Hyperterminal's Help for information about using Hyperterminal.

There are two things you need to know before you can connect to another computer:

- ❖ The communications parameters
- ❖ The file transfer protocol (only if you're downloading or uploading files)

The following sections explain what these mean.

Communications Parameters

There are four communications parameters:

- ❖ Modem speed is the speed at which the modem transfers information. Speeds are measured in bits per second. Your modem manual documents the speed of your modem.
- ❖ Data bits is the number of bits in one character. This number is usually seven or eight.
- ❖ Stop bits indicate the end of a character. This number is usually one or two.
- ❖ Parity is an error-checking method and will be set to even, odd or none.

These parameters, except for the modem speed, are usually abbreviated and combined. Common examples are N81 (no parity, eight data bits and one stop bit) and E72 (even parity, seven data bits and 2 stop bits).

You set each of these parameters in your communications program. Each parameter must be set the same on both computers or you won't be able to connect.

File Transfer Protocols

File transfer protocols are standards that govern how computers transfer files between modems over a telephone line. Protocols determine what type of error checking and data compression, if any, occur during transfer. Based on a number of factors, some

protocols are faster than others. Popular protocols include XMODEM (one of the earliest and still one of the most reliable protocols) and ZMODEM (about the fastest available these days).

You don't really need to know anything about specific protocols—just make sure you're using the same as the computer with which you're communicating. If you would like to know more, protocols are described in any book on telecommunications, available at your local book or computer store.

Using Bulletin Board Services

Local electronic bulletin board services (BBSs), like their mundane counterpart hanging on your wall, let you post messages for friends, or questions to which a wide variety of people can respond. Many BBSs also offer software (programs) or shareware that you can copy to your computer (called downloading).



Shareware programs are copyrighted programs that you can try out for free. If you decide you like the program, you must send in a small registration fee. Upon registering some shareware programs, you may receive additional benefits, such as a printed manual or free future upgrades.

Most BBSs serve a particular interest group and are run by an individual or small group of people. For example, a science fiction BBS may have messages from people looking for out-of-print books and offer a few sample sections of new works.

Most computer companies offer a BBS as one way to provide customers with software updates and answers to their questions. Toshiba's 24-hour BBS offers Toshiba computing information and is a good source of Toshiba utilities files and technical bulletins. Complete information about accessing Toshiba's BBS is found in "Toshiba's Bulletin Board Service" on page 298.

To access a BBS, you'll need an all-purpose communications program, such as Hyperterminal, provided with Windows 95. See the following section for information about using all-purpose communications programs.

Discovering Toshiba's On-line Resources

In addition to the Toshiba Internet sites listed under "WWW Sites" on page 204, Toshiba maintains a number of on-line sites to which you can connect. These sites can provide information about Toshiba products, help with technical questions and keep you up to date with future upgrades.

- ❖ On CompuServe, type go toshiba.
- ❖ To access Toshiba's BBS, set your modem to N81 and call 714-837-4408.

Using Your Computer on Your Desk

Your Satellite 200 Series computer was designed to be easy to carry around and use while you travel. However, it's also powerful enough to use as your primary desktop computer.

This chapter describes how to connect several optional devices that can make your computer at home on your desk.

Using an External Monitor

You can easily attach an external monitor to your computer. Some external monitors display more information than the computer's built-in screen is capable of displaying. Also, having an external monitor makes the entire display bigger.

Connecting an External Monitor

To connect an external monitor, follow these steps:

- 1 Turn the computer off.**

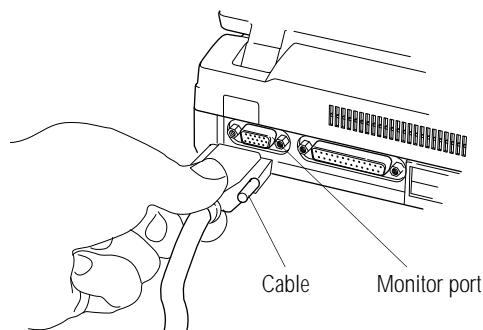

Connecting an external monitor

- 2 Connect the monitor's video cable to the monitor port on the back of the computer.**
- 3 Turn the external monitor on.**
- 4 Turn the computer on.**

The computer uses the external monitor.

If your external monitor can display higher resolution video modes than 800 by 600, you can take advantage of this feature by changing the video mode. To do this, see “Changing the Display Mode” on page 257.

Directing the Display When You Turn the Computer On

When you turn the computer on, it sends information to the external monitor. To send information to the built-in display as well, you'll need to change the Power On Display setting in Hardware Setup or TSETUP. This option has two settings:

- ❖ Internal/External sends the display to the external monitor. If no external monitor is attached, it sends information to the computer's built-in display. (This is the default).
- ❖ Simultaneous sends display output to both the external monitor and the built-in display. This is especially useful if you're mak-

ing a presentation and wish to guide the discussion from your notebook computer.



NOTE

Simultaneous mode won't work if your external monitor can't display resolutions higher than 640 by 480.

This section explains how to change the Power On Display option using Hardware Setup. To change this option using TSETUP, see “TSETUP” on page 341.

The Hardware Configuration program lets you set configuration options in Windows 95. To set the Power On Display option in Windows 95, follow these steps:

- 1 Click Start, then point to Programs.**
- 2 Point to Toshiba Utilities, then click Hardware Setup.**

Hardware Setup displays the Hardware Configuration dialog box.

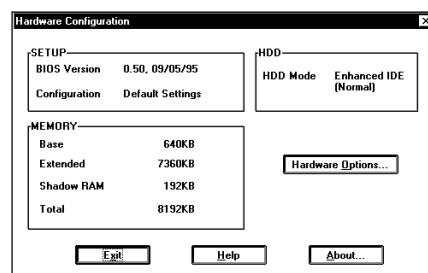

The Hardware Configuration dialog box

This box contains information about the system.

- 3 Click Hardware Options.**

Hardware Setup displays the Hardware Configuration Options dialog box.

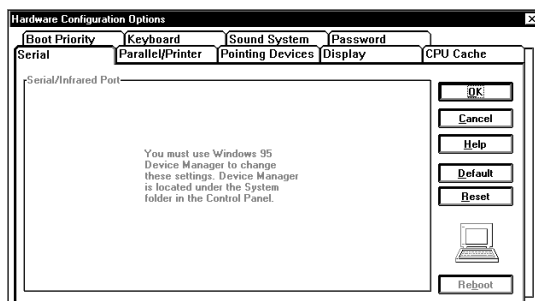

The Hardware Configuration Options dialog box

4 Click the Display tab.

Hardware Setup displays a page of display options.

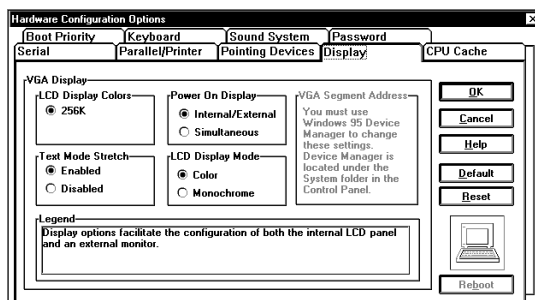

The Display page

5 Click the circle to the left of the desired Power On Display setting.

6 Click OK.

Hardware Setup displays a dialog box asking if you want to reboot (restart) the computer.

7 Click Yes or No:

- ❖ Yes restarts the computer immediately with your changes in effect.
- ❖ No allows you to save files. After you save, restart the computer using the reset button or Ctrl + Alt + Del to make your changes take effect.

Using an External Keyboard

If you prefer to use a standard desktop keyboard, you can attach one to your computer. The PS/2 port supports any PS/2-compatible keyboard.



You can only connect one PS/2 device at a time. If you're already using a PS/2 mouse, you must remove it before connecting a keyboard or you can purchase a Y-cable from your dealer to simultaneously support both devices.

Connecting the Keyboard

To connect an external keyboard, follow these steps:

1 Turn the computer off.



Make sure the computer is off before you attach the keyboard. Connecting a keyboard with the computer's power on may damage the keyboard, the computer or both.

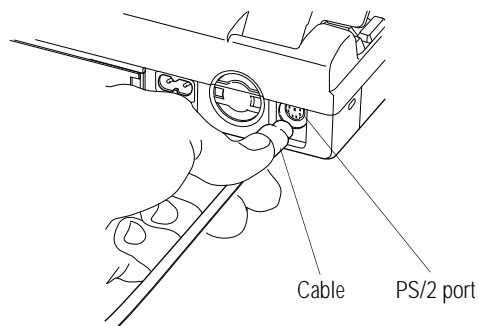

Connecting an external keyboard

2 Attach the keyboard cable to the PS/2 port on the back of the computer.

- 3 See the keyboard's documentation for additional configuration steps.
- 4 Turn the computer on.

The keyboard is ready to use. If you experience any problems, refer to "The Keyboard" on page 285.

Making Your External Keyboard Pretend it Has the Fn Key

An external keyboard doesn't have the Fn key contained on the Satellite 200 Series computer's built-in keyboard. If you use the computer's hotkeys or have set up key combinations in Fn-esse, you'll probably miss these features when using an external keyboard. Don't worry: with the Fn Key Emulation option in Hardware Setup or TSETUP, you can make your external keyboard act as if it had the Fn key.

For more information about Fn-esse, see "Starting Programs Faster" on page 241.

To find out how to set the Fn Key Emulation option using TSETUP, see "TSETUP" on page 341.

To set the Fn Key Emulation option in Hardware Setup, follow these steps:

- 1 Click Start, then point to Programs.
- 2 Point to Toshiba Utilities, then click Hardware Setup.

Hardware Setup displays the Hardware Configuration dialog box.

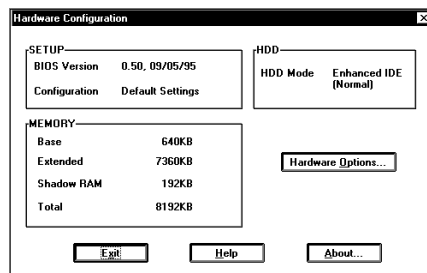

The Hardware Configuration dialog box

3 Choose Hardware Options.

Hardware Setup displays the Hardware Configuration Options dialog box.

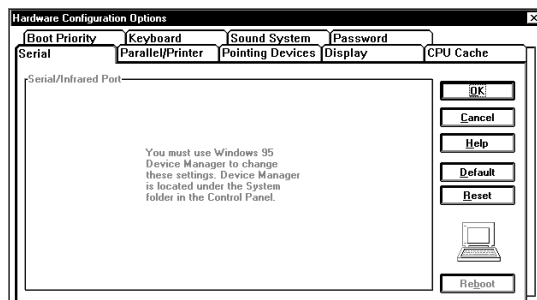

The Hardware Configuration Options dialog box

4 Click the Keyboard tab.

Hardware Setup displays a page with the External Keyboard Fn Key option.

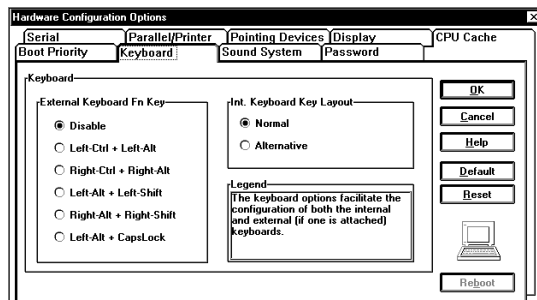

The Keyboard page

- 5 Click the circle to the left of the desired External Keyboard Fn Key setting.
- 6 Choose OK to close Hardware Setup with your setting in effect.

Using a Serial Mouse

You may want to use a mouse instead of the AccuPoint. You can use a serial mouse or a PS/2 mouse. See “Using a PS/2 Mouse” on page 220 if you wish to use a PS/2 mouse.

Connecting the Mouse

To connect a serial mouse, follow these steps:

- 1 Turn the computer off.**

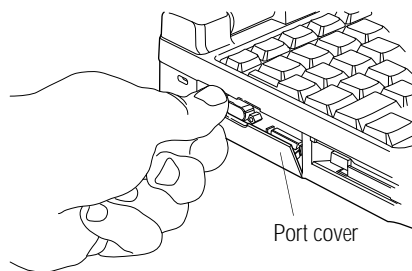

Opening the port cover

- 2 Open the port cover on the left side of the computer.**

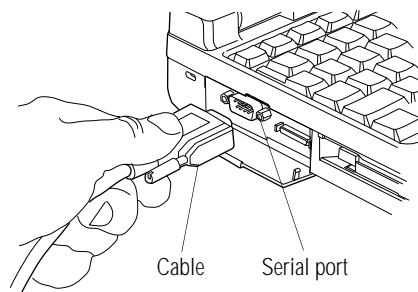

Connecting the cable to the serial port

- 3 Plug the mouse cable into the computer's serial port.**
- 4 Turn the computer on.**

Configuring the Mouse in Windows 95

Before you use the serial mouse for the first time, you will need to complete the following steps:

1 Click the Start button and point to Settings

2 Click Control Panel.

Windows 95 displays the Control Panel.

3 Double-click Add New Hardware.

Windows 95 starts the Add New Hardware Wizard.

4 Click Next.

The Add New Hardware Wizard asks if it should search for new hardware.

5 Select No, then click Next.

The Add New Hardware Wizard prompts you to choose a hardware type.

6 Select Mouse, then click Next.

The Add New Hardware Wizard prompts you to choose your mouse.

7 Select your mouse from the list provided and click Next.

Typically, you'll select Standard Serial Mouse.

8 Click Finish, then Yes to load the new settings.

Using a PS/2 Mouse

If you prefer to use a PS/2-compatible mouse, you can attach one to your computer. The PS/2 port supports any PS/2-compatible mouse.



You can only connect one PS/2 device at a time. If you're already using a PS/2 keyboard, you must remove it before connecting a mouse.

Connecting the PS/2 Mouse

To connect a PS/2 mouse, follow these steps:

1 Turn the computer off.



Make sure the computer is off before you attach the mouse. Connecting a mouse with the computer's power on may damage the mouse, the computer or both.

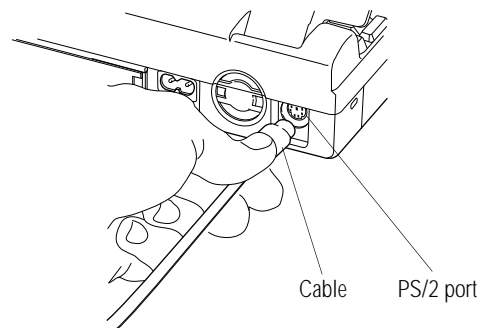

Connecting a PS/2 mouse

2 Attach the PS/2 mouse cable to the PS/2 port on the back of the computer.

- 3 See your mouse documentation for additional configuration steps.
- 4 Turn the computer on.

Setting Up a PS/2 Mouse

If you connect a PS/2 mouse to PS/2 port, you may use the mouse, the AccuPoint or both.

To set how the PS/2 mouse works with the AccuPoint, follow these steps:

- 1 Click Start, then point to Programs.
- 2 Point to Toshiba Utilities, then click Hardware Setup.

Hardware Setup displays the Hardware Configuration dialog box which contains information about your system.

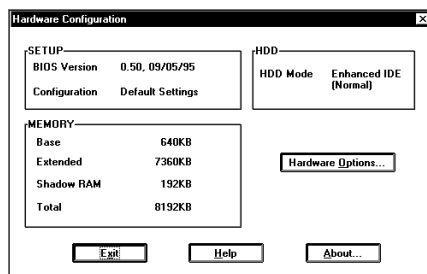

The Hardware Configuration dialog box

- 3 Choose Hardware Options.

Hardware Setup displays the Hardware Configuration Options dialog box.

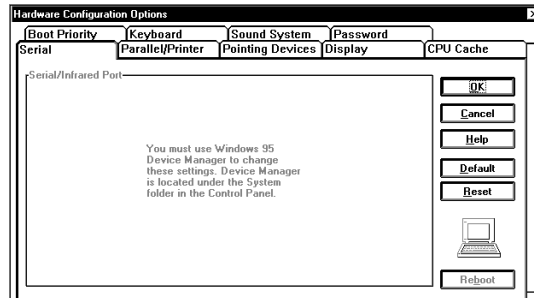

The Hardware Configuration Options dialog box

4 Click the Pointing Devices tab.

Hardware Setup displays a page of pointing device options.

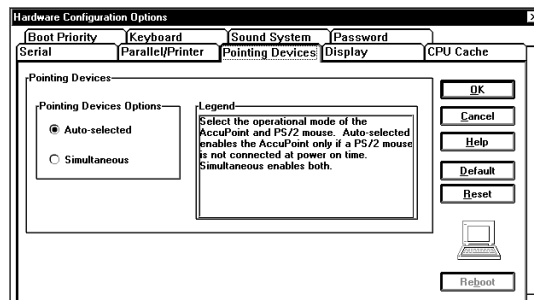

The Pointing Devices page

5 Choose the desired option.

Auto-Selected checks for a PS/2 mouse. If one is connected, Hardware Setup makes the mouse active and disables. If no PS/2 mouse is connected, the AccuPoint is active.

Simultaneous lets you use both the AccuPoint and the PS/2 mouse.

6 Click OK.

Hardware Setup displays a dialog box asking if you want to reboot (restart) the computer.

7 Click Yes or No.

- ❖ Yes restarts the computer immediately with your changes in effect.
- ❖ No lets you save open files. After you save, restart the computer using the reset button or Ctrl + Alt + Del to make your changes take effect.

Using the Optional NoteDock

The optional NoteDock port allows you to connect your Satellite 200 Series computer to an optional NoteDock. The NoteDock is an excellent investment if you're using your computer both in and out of the office.

Imagine that you're a salesperson who frequently works away from the office. When you return to your desk, you want to be able to connect to your network, print reports from your computer, and use a mouse instead of the AccuPoint. Connecting cables for each of these devices every time you return to the office is time-consuming and inconvenient.

By connecting external devices to the NoteDock instead of directly to your computer, you can leave the devices connected while you are using your computer away from your desk. When you return, you can quickly connect your computer to the NoteDock and have immediate access to the devices.

NoteDock Features

This section identifies and describes the features of the NoteDock.

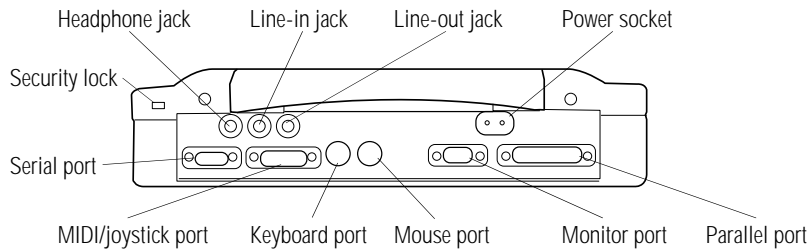

The rear of the NoteDock



Use the **headphone jack** to connect stereo headphones or externally powered speakers.



Use the **audio line-in jack** to play and record stereo sound from an external audio device, such as a stereo system.



Use the **audio line-out jack** to connect your computer to a tape recorder or a stereo amplifier to record or play sounds from your computer.



Use the **serial port** to connect a serial device, such as a serial printer, modem or mouse. This port replaces the computer's serial port.



The **MIDI/Joystick port** lets you connect a joystick or a MIDI device, such as a synthesizer.



Use the **PS/2 mouse port** to connect a PS/2-compatible pointing device. With the NoteDock, you can use both a PS/2-compatible pointing device and a PS/2 keyboard at the same time.



Use the **PS/2 keyboard port** to connect a PS/2 keyboard. This port replaces the computer's PS/2 keyboard port. With the NoteDock, you can use both a PS/2 keyboard and a PS/2-compatible pointing device at the same time.



Use the **monitor port** to connect an external monitor. This port replaces the computer's monitor port.



Use the **parallel port** to connect a parallel printer or other parallel device. This port replaces the computer's parallel port.



Use the **power socket** to connect the NoteDock to AC power, using a power cord.



Use the **security lock slot** to attach a security cable to the NoteDock. This cable is discussed in "Applying Physical Restraints" on page 238.

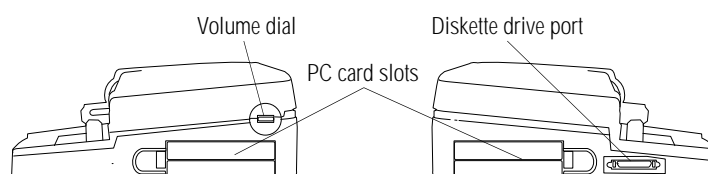

The right and left sides of the NoteDock



Use the two **PC card slots** to install Type III PC cards. The slot on the right of the NoteDock is referred to as Slot 2. The slot on the left side is referred to as Slot 3. For more information, see "Using PC Cards in the NoteDock" on page 227.

Use the **volume dial** to adjust the loudness of the system speaker.



Use the external **diskette drive port** to connect the external 3.5-inch diskette drive.

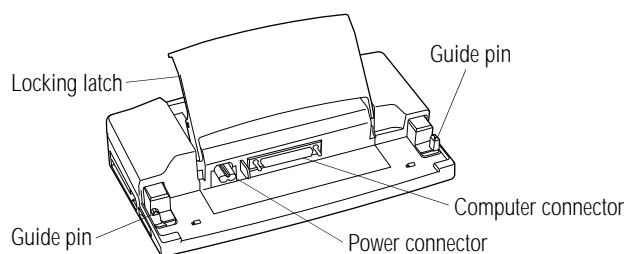

The front of the NoteDock

The view of the NoteDock above identifies:

- ❖ the **locking latch** and **metal latches** that secure the computer to the NoteDock.

- ❖ the **computer connector** that connects to the NoteDock port on the back of your computer.
- ❖ the **power connector** that provides power to the computer when you connect the NoteDock to a power source.
- ❖ the **guide pins** that help align the computer with the NoteDock, ensuring a proper connection.

Connecting the Computer to the NoteDock

To attach the computer to the NoteDock, follow these steps:

- 1 Turn the computer off.**
- 2 Remove all cables from the back of the computer.**

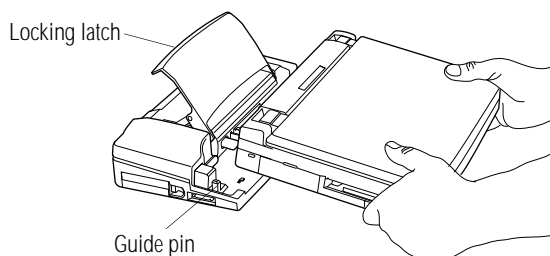

Attaching the computer to the NoteDock

- 3 Lift the locking latch on the NoteDock.**
- 4 Align the two holes on the bottom of the computer with the guide pins on the NoteDock.**
- 5 Gently press the locking latch down.**
The computer slides into place and connects to the NoteDock.
- 6 Attach the power cord to the NoteDock's power socket.**
- 7 Connect the power cord to a wall socket.**

To disconnect the computer from the NoteDock, turn the computer's power off, lift the locking latch and remove the computer.

Using PC Cards in the NoteDock

The NoteDock provides two additional PC card slots. These slots function in the same way as those in the computer.

For information about setting up PC cards, refer to “Setting Up Your PC Card for Your Computer” on page 177.

The first time you use the NoteDock, Windows 95 will create a “Dock 1” configuration, that will be able to determine when you are docked (connected) to the NoteDock.

To use the PCMCIA card slots in the NoteDock, you may need to set up PC card support the first time you connect to the NoteDock. To set up PC card support, follow these steps:

- 1 Click the Start button and point to Settings.**
- 2 Click Control Panel.**
Windows 95 displays the Control Panel.
- 3 Select the PC card (PCMCIA) icon.**
- 4 Follow the setup instructions.**

Keeping Your Files Safe

At some time, you'll almost certainly have files on your computer that you want to keep private. Your Satellite 200 Series computer comes with several options that can help you keep your computer and files safe from unwanted intrusion.

This chapter describes the security options for your notebook computer.

Using a Password

Setting a password lets you leave your computer, secure in the knowledge that nobody can access your files. When you set a password, you must enter the password before you can work on your computer again.

Toshiba supports three types of passwords:

- ❖ A power-on password requires you to enter the password every time you start or resume the computer. You do not need to enter the password when you restart (Ctrl + Alt + Del).

- ❖ An instant password lets you get up and walk away from your computer for a few moments without having to turn the computer off.
- ❖ A supervisor-level password protects system settings by restricting who can make changes in MaxTime, Hardware Setup and TSETUP. This is useful if more than one person is using the computer.

Working with User-Level Passwords

The user-level password is the basic level of password security. For most users, this is all the password security you'll need.

You may create a user-level password in either Hardware Setup or TSETUP. This section describes how to create a user-level password in Hardware Setup and how to use it as an instant and power-on password.

When you create a password in TSETUP you may also create a password service diskette. You can use this diskette to start the computer if you forget your password. "Password Retrieval" on page 232 describes how to create a user-level password and password service diskette in TSETUP.

Creating a User-Level Password



When you register a password in Hardware Setup, you cannot create a password service diskette. If you forget your password, you must contact Toshiba (US telephone number 800-999-4273) before you can start your computer again. To register a password and create a password service diskette, follow the steps in "Password Retrieval" on page 232 to use TSETUP.

To create (register) a password in Hardware Setup, follow these steps:

- 1 Click Start, then point at Programs.**

2 Point at Toshiba Utilities, then click Hardware Setup.

Hardware Setup displays the following dialog box:

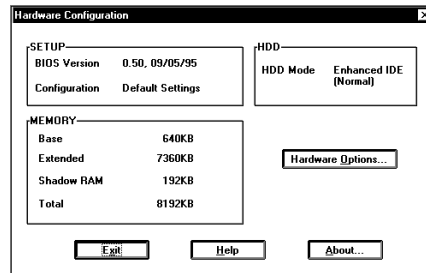

The Hardware Configuration dialog box

3 Click Hardware Options.

Hardware Setup opens the Hardware Configuration Options screen.

4 Click the Password tab to access the Password page.



The Password page

5 Click Registered.

Hardware Setup asks you to enter a password.

6 Type a password of one to 16 characters and press Enter.

You may use any combination of letters and numbers in your password.

7 When Hardware Setup prompts you to do so, verify the password by typing it again and pressing Enter.

If the two passwords match, Hardware Setup displays:
Registered.

If the two passwords don't match Hardware Setup displays an error message. Repeat steps 5 and 6 to enter the password again.

8 If you would like, you may also enter an Owner String

The Owner String will appear with the password message any time you start or restart the computer.

9 Continue with the next section to create a password service diskette.

Password Retrieval

If you ever forget your password, a password service diskette lets you bypass the password when starting your computer. You can create a password service diskette when you register a password in TSETUP.



If you forget your password and have lost your password service diskette, contact Toshiba service (US telephone number 800-999-4273).

To register a password in TSETUP and create a password service diskette, follow these steps:

1 If your diskette drive is not installed in the SelectBay, connect the external diskette drive or swap drives in the SelectBay.

To swap drives, see “Swapping Drives in the SelectBay” on page 104.

2 Insert a diskette into the diskette drive.



NOTE

Run TSETUP outside of Windows 95, at a system prompt. If you try to run TSETUP from an MS-DOS session under Windows 95, results can be unpredictable.

3 If you're currently in Windows 95, click Start, then click Shut Down.

4 Click the button next to Restart the computer in MS-DOS mode and click Yes.

Windows 95 shuts down the computer, then restarts it in MS-DOS mode and displays a system prompt.

5 Type: c:\dos\tsetup

TSETUP displays a screen similar to the following:

| MEMORY | | SYSTEM SETUP | | I/O PORTS | |
|---------------------|-------------------------|--------------------|--------------------|---------------------|--|
| Total | = 8192KB | Serial Port | = COM1 (IR04/3FBH) | BIOS VERSION = X.XX | |
| Base | = 640KB | Infrared Port | = Not Used | | |
| Extended | = 7360KB | Parallel Port | = LPT1 (378H) | | |
| Shadow BIOS ROM | = 192KB | Sound System | = Address/IRQ/DMA | | |
| DISPLAY | | OTHERS | | | |
| Display Adaptor | = VGA Compatible | Power-up Mode | = Boot | | |
| LCD Display Mode | = Color | CPU Cache | = Enabled | | |
| VGA Segment Address | = E000H | Battery Save Mode | = Full Power | | |
| LCD Display Colors | = 256K Colors | Alarm Volume | = High | | |
| Power On Display | = Internal/External | System Beep | = Enabled | | |
| Text Mode Stretch | = Enabled | Panel Power On/Off | = Disabled | | |
| HARD DISK | | Alarm Power On | = Disabled | | |
| HDD Mode | = Enhanced IDE (Normal) | Keyboard | = Layout/Fn | | |
| PASSWORD | | Pointing Devices | = Auto-Selected | | |
| Not Registered | | Boot Priority | = FDD→HDD | | |

↑←→:Select items Space, BkSp:Change Values
Esc:Exit without saving Home:Set default values End:Save changes and Exit

A sample System Setup screen

6 Press p to highlight the Password section.

7 Press the spacebar.

TSETUP asks you to enter a new password.

8 Type a password of one to 16 characters and press Enter.

You may use any combination of letters and numbers in your password.

9 When TSETUP prompts you to do so, verify the password by typing it again and pressing Enter.

If the two passwords match, TSETUP displays: Registered.

If the two passwords don't match TSETUP displays an error message. Repeat steps 6 and 7 to enter the password again.

10 Press End to save your change and close TSETUP.

11 Press Y to confirm you want to quit.



The computer overwrites all existing information on the password service diskette. Make sure the diskette you use does not contain any important information.

TSETUP asks you to enter the type of diskette you're using.

12 Press 2 if you're using a 1.44 MB diskette or press 1 if you're using a 720 KB diskette.

TSETUP creates the password service diskette and displays a message when it's finished.

13 Remove the diskette and press any key to continue.

TSETUP closes, returning you to the system prompt. The next time you start the computer your password will be in effect.

14 Place your password service diskette in a safe place, away from the computer.



Do not use your password service diskette for any other purpose. If you try to access the diskette, you'll receive an error message, and will have to reset your password and create a new password service diskette.

Power-On Password

Whenever you start or restart your computer with a power-on password in effect, the computer prompts you to enter the password before it goes through its normal startup procedure. The power-on password operates whether or not the computer is operating in Resume Mode.

When your computer prompts you to enter your password, type it in and press Enter. If you enter the password correctly, the computer continues with its normal startup procedure. If you enter an incorrect password, the computer beeps. After three incorrect attempts, the beep sounds repeatedly and turns off automatically.

If you've forgotten your password, follow these steps:

1 If your diskette drive is not installed in the SelectBay, connect the external diskette drive or swap drives in the SelectBay. To swap drives, see “Swapping Drives in the SelectBay” on page 104.

2 Turn the computer on with Resume Mode turned off.

The system prompts you for your password.

3 Insert the write-enabled password service diskette into the diskette drive and press Enter.

The system prompts you, “Set Password Again (Y/N)?”



The password service diskette is not reusable. Once you use it, you must create a new diskette, even if you set the same password.

4 To enter TSETUP and reset your password, press Y. Follow the instructions in “Password Retrieval” on page 232 to reset your password.

To remove your password, press N. It will no longer be registered.

Instant Password

An instant password secures your system with a single keystroke. Use this feature when you need to leave your desk for a few minutes and don't want to turn the computer off.

To use an instant password, press Fn + F1. Pressing this hotkey freezes the keyboard and AccuPoint and blanks the screen. An instant password has no effect on an optional serial mouse or trackball.

To unlock the password, follow these steps:

- 1 **Press** Enter.

If a password is registered, the screen remains blank.

- 2 **Enter your password and press** Enter.

If you enter the password correctly, the computer returns to where it was when you pressed the hotkey.

Disabling a User-Level Password

To disable your password, follow these steps:

- 1 **Click Start, then point at Programs.**

- 2 **Point at Toshiba Utilities, then click Hardware Setup.**

Hardware Setup displays the following dialog box:

- 3 **Click Hardware Options.**

Hardware Setup opens the Hardware Configuration Options screen.

- 4 **Click the Password tab to access the Password page.**

- 5 **Click Not Registered.**

Hardware Setup asks you to enter the current password.

- 6 **Type the existing password and press** Enter.

If you entered the correct password, Hardware Setup displays Not Registered.

If you entered an incorrect password, Setup displays an error message. Repeat steps 5 and 6 to enter the password again.

If you enter an incorrect password three times, Hardware Setup displays an Access Denied message indicating that you cannot change the password. The password remains registered.

- 7 Click OK to restart the computer with the password disabled.**

Working with Supervisor-Level Passwords

When a supervisor-level password is set, you must enter the supervisor password to make changes in MaxTime, Hardware Setup or TSETUP. This section describes how to create and use a supervisor-level password.

Creating a Supervisor-Level Password

To create a supervisor-level password, follow these steps:

- 1 If you're currently in Windows 95, click Start, then click Shut Down.**
- 2 Click the button next to Restart the computer in MS-DOS mode and click Yes.**

Windows 95 shuts down the computer, then restarts it in MS-DOS mode and displays a system prompt.

- 3 Type `c:\dos\svpw` and press Enter.**

The Supervisor Password program asks if you want to register (create) a password.

- 4 Press Y.**

The Supervisor Password program asks you to enter a password.

- 5 Type in a password and press Enter.**

A password can be any combination of up to 10 letters and numbers. To protect from spying eyes, the Supervisor Pass-

word program displays an asterisk (*) for each character you type.

The Supervisor Password program indicates that your password is registered.

- 6 Type in the password again to verify it and press** Enter.
- 7 Type** exit **to return to Windows 95.**

Deleting a Supervisor-Level Password

To delete a supervisor-level password, follow these steps:

- 1 If you're currently in Windows 95, click Start, then click Shut Down.**
- 2 Click the button next to Restart the computer in MS-DOS mode and click Yes.**

Windows 95 shuts down the computer, then restarts it in MS-DOS mode and displays a system prompt.

- 3 Type** c:\dos\svpw **and press** Enter.

The Supervisor Password program asks if you want to delete a password.

- 4 Press Y.**

The Supervisor Password program asks you to enter your password. Once again, the program displays an asterisk for each character you type.

- 5 The Supervisor Password program indicates that a password is not registered.**
- 6 Type** exit **to return to Windows 95.**

Applying Physical Restraints

You can connect the optional Noteworthy Computer Lock cable to deter theft. One end of this cable fits into the security lock slot on the left side of the computer. Secure the other end of the cable to your desk or other large, heavy object.

If you're using an optional NoteDock, you'll want to purchase two of these cables: one for the computer and another for the NoteDock.

Viruses and How To Cure Them

Over the last few years, there have been a number of computer virus scares. Pranksters with too much time on their hands find perverse pleasure in unleashing these potentially destructive programs on the general public.

Viruses, while a potential problem, don't need to have a devastating effect on your computer. By taking a few simple precautions, you can avoid infection. And, by making sure you have a complete backup of all your programs and data files, you can ensure a speedy recovery if you do run into problems.

There are many virus detection/removal programs available. Ask your dealer for help in selecting one that adequately meets your needs.

Making Life Easier

Your Satellite 200 Series computer is already a computing powerhouse right out of the box. You can run the most powerful business programs and work for hours away from an external power source without needing to change anything. By adding extras and using the additional built-in features of your computer, you can make your life even easier.

This chapter discusses some convenient options that are already included with your computer.

Starting Programs Faster

Normally, when you have a Windows program open and want to open a different program, you need to wade through the long maze of the Start menu. While you may use Windows 95 shortcuts, Toshiba's Fn-esse program provides a quick way to open programs and documents from within any Windows program.

By assigning a key combination with the Fn key, you can:

- ❖ open a Windows program or a document in a Windows program.

- ❖ display a pop-up list of Windows programs and/or documents from which to choose.
- ❖ switch between open programs and documents.

You can assign any key that is not associated with a hotkey or a keyboard overlay. This section explains how to assign your Fn key combinations and use them to open programs and documents quickly.

Starting Fn-esse

To start Fn-esse, follow these steps:

- 1 Click Start, and point to Programs.**
- 2 Point to Toshiba Utilities, then click Fn-esse.**

Fn-esse displays the Fn-esse window:



The Fn-esse window

The keys are color coded as follows:

- ❖ available keys are black
- ❖ assigned keys are blue
- ❖ unavailable keys are dark gray
- ❖ keys associated with a pop-up list have a small dot on the upper left corner of the key

Assigning a Key to a Program or Document

There are three ways to assign a key to open a program or document:

- ❖ drag-and-drop
- ❖ the Browse for Applications dialog box

- ❖ the Application Explorer dialog box

The following sections describe each of these methods. Experiment with each to find the one that best suits your tastes.

Using Drag-and-Drop

To use the drag-and-drop method of assigning a key to a program or document, follow these steps:

- 1 Open both Fn-esse and the Windows Explorer.**
- 2 Resize the Explorer window so that you can see both the Fn-esse keyboard and the Explorer at the same time.**

If you're unsure how to do this, refer to "Lesson 6: Resizing and Reshaping Windows" on page 60.

- 3 In the Explorer window, highlight the program or document file you wish to assign to a key.**
- 4 Click and hold the primary button as you drag the highlighted item from the Explorer to the key on the Fn-esse keyboard to which you wish to assign it.**
- 5 Release the primary button.**

Fn-esse displays the Add/Edit Command dialog box completely filled in to reflect the selected program or document.

- 6 Choose OK to close the Add/Edit Command dialog box with your key assignment in place.**

The program or document is now associated with the key you just selected. To open the program or document, press Fn plus the appropriate key from within any Windows program.

Using the Browse for Applications Dialog Box

To use the Browse for Applications dialog box to assign a key to a program or document, follow these steps:

- 1 Click the desired key in the Fn-esse keyboard with the secondary button.**

Fn-esse displays the Assignment Type dialog box.

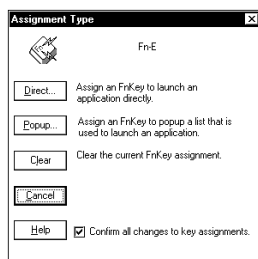

The Assignment Type dialog box

2 Choose Direct.

Fn-esse displays the Add/Edit Command dialog box:

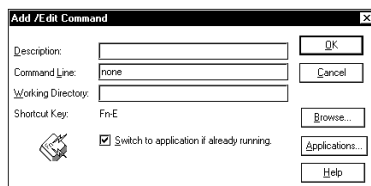

The Add/Edit Command dialog box

3 Choose Browse.

Fn-esse displays the Browse for Applications dialog box.

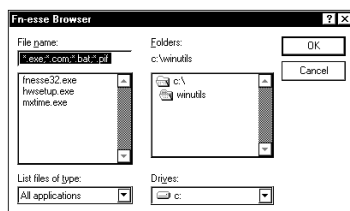

The Browse for Applications dialog box

4 Use the Drive and Directory fields to locate your file.

You may narrow down your search with the List Files of Type list box.

5 In the File Name field, highlight the file you wish to assign to the key and choose OK.

Fn-esse displays the Add/Edit Command dialog box completely filled in to reflect your choice.

6 Choose OK to save your key assignment and exit the dialog box.

The program or document is now associated with the key you just selected. To open the program or document, press Fn plus the appropriate key from within any Windows program.

Using the Application Explorer Dialog Box

To use the Application Explorer dialog box to assign a key to a program or document, follow these steps:

1 Click the desired key in the Fn-esse keyboard with the secondary button.

Fn-esse displays the Assignment Type dialog box.

2 Choose Direct.

Fn-esse displays the Add/Edit Command dialog box.

3 Choose Applications.

Fn-esse displays the Application Explorer dialog box.

4 Select the desired program folder.

5 Select the desired program or document and choose OK.

6 Fn-esse displays the Add/Edit Command dialog box again with everything filled in to reflect your choice.

7 Choose OK.

The program or document is now associated with the key you just selected. To open the program or document, press Fn plus the appropriate key from within any Windows program.

Defining a Pop-up Key Assignment

To assign a key to open a program or document from a pop-up list, follow these steps:

- 1 Click the desired key in the Fn-esse keyboard with the secondary button.**

Fn-esse displays the Assignment Type dialog box:

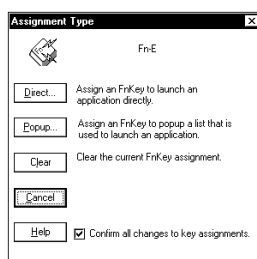

The Assignment Type dialog box

- 2 Choose Popup.**

Fn-esse displays the Application Explorer dialog box.

- 3 Select the desired folder.**

The left side of the Application Explorer displays the folders in the Programs menu. The right side lists the programs and documents in the folder. These are the items that will appear in the pop-up list. To create a pop-up list with items from various folders, or to pick only a few items from a folder, create a new folder containing only the desired programs and documents. If you're unsure how to do this, refer to your Windows 95 documentation.

- 4 Choose OK.**

The folder is now associated with the key you just selected. To open a pop-up list showing the items in that folder, press Fn plus the appropriate key from within any Windows program.

Viewing Existing Key Assignments

To view the existing key assignments, choose Assignments from the Fn-esse keyboard. Fn-esse displays the Function Key Assignments dialog box:

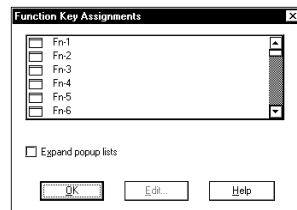

The Function Key Assignments dialog box

This box lists all the key assignments and the program or document to which they're assigned. To view items in a pop-up list, choose the Expand pop-up lists checkbox.

The buttons at the bottom of the dialog box operate as follows:

- ❖ OK exits the dialog box.
- ❖ Edit opens the Assignment Type dialog box, allowing you to change a key assignment.
- ❖ Help displays context-sensitive on-line help.

Changing or Removing Existing Key Assignments

To change or remove an existing key assignment, follow these steps:

- 1 Click in the Fn-esse keyboard on the key you wish to change with the secondary button.**

Fn-esse displays the Assignment Type dialog box.

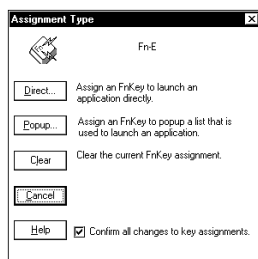

The Assignment Type dialog box

2 To change the key assignment, choose Direct or Popup and continue as if you were creating a new assignment.

To remove the key assignment, choose Clear.

Options

This section describes additional Fn-esse options. All of these are accessed through the Fn-esse Options menu.

Setting Colors

Choosing Colors opens an additional menu with the following choices:

- ❖ Assigned Keys sets the color for the assigned keys.
- ❖ Mark Popups sets the color for the dot indicating a key assigned to a pop-up list.
- ❖ Hints sets the background color for pop-up hints.

Keeping Fn-esse On Top

Choosing (checking) Always on Top keeps the Fn-esse keyboard on top of your currently active window.

Marking Pop-ups

Choosing (checking) Mark Popups marks keys assigned to pop-up lists with a small dot on the Fn-esse keyboard.

Automatically Minimizing the Fn-esse Window

Choose (check) Minimize on Use to minimize the Fn-esse window automatically when you use it to open or switch to a program or document.

Displaying Hints

Pop-up hints appear on the Fn-esse keyboard whenever you move the AccuPoint pointer slowly over the keys. Hints show you what program, program group or document is associated with a particular key.

If a key is unassigned, the hint reads “~NONE~.”

Choosing Hints from the Options menu turns pop-up hints on and off.

Confirming Key Assignment Changes

If you choose Confirm Changes from the Options menu, Fn-esse asks you to confirm changes in existing key assignments.

Working with the Keyboard

This section introduces additional keyboard options.

Making Your Keyboard Pretend it Has More Keys

The 101-key enhanced keyboard has two Enter, Ctrl and Alt keys. The Satellite 200 Series keyboard has only one of each.

Most of the time there's no difference between the two keys. However, some programs assign separate functions to the right and left Ctrl and Alt keys, or to the regular and numeric pad Enter keys on the enhanced keyboard. The Fn key allows the Satellite 200 Series keyboard to simulate these separate keys, as follows:

- ❖ Press Fn + Ctrl to simulate the Ctrl key on the right side of the enhanced keyboard.

- ❖ Press Fn + Alt to simulate the Alt key on the right side of the enhanced keyboard.
- ❖ Press Fn + Enter to simulate the Enter key on the numeric pad of the enhanced keyboard.

The Cursor Control Overlay

The keys with the white arrows and blue symbols on the left front are the cursor control overlay. This illustration highlights the keys in the cursor control overlay:

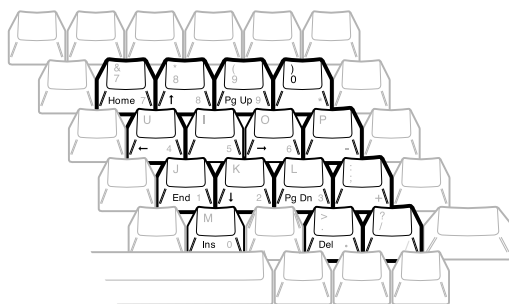

The cursor control overlay

You can use these keys to:

- ❖ move the cursor up, down, left or right on the screen.
- ❖ move up or down one page.
- ❖ move to the beginning or end of a document.
- ❖ delete or insert characters.

How these keys function may vary with the program you're using. Check your program's documentation for information on how the cursor keys function.

To turn the cursor control overlay on and off, press Fn + F10. The cursor control light on the indicator panel shows whether the cursor control overlay is on or off.

You can use the overlaid keys to type alphabetic characters while the overlay is on. To do this:

- ❖ for lower case letters, press and hold Fn while you type.
- ❖ for upper case letters, press and hold Fn + Shift while you type.

To use the numeric keys when the cursor control overlay is on, press and hold Shift while you use the overlaid keys. To return to the cursor control overlay, release Fn.

Selecting the Keyboard Layout

Depending on what type of computer keyboard you are accustomed to, the position of the Caps Lock, Ctrl and Alt keys on your computer may seem odd to you. You can change the layout of these keys by setting the Int. Keyboard Key Layout option in Hardware Setup or TSETUP:

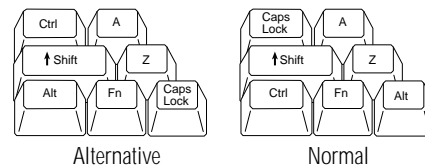

The Alternative and Normal keyboard key layouts

If you plan on using the Alternative layout permanently, an authorized service provider can change the keytops for you.

To find out how to set the Int. Keyboard Key Layout option using TSETUP, see “TSETUP” on page 341.

To set the Int. Keyboard Key Layout option in Hardware Setup, follow these steps:

- 1 Click Start, then point to Programs.**
- 2 Point to Toshiba Utilities, then click Hardware Setup.**

Hardware Setup displays the Hardware Configuration dialog box.

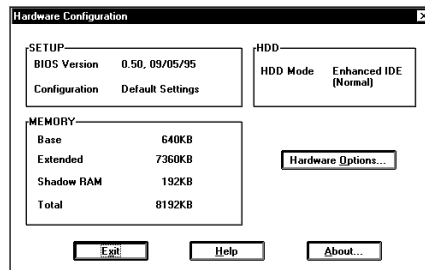

The Hardware Configuration dialog box

This box displays information about the system.

3 Choose Hardware Options.

Hardware Setup displays the Hardware Configuration options dialog box.

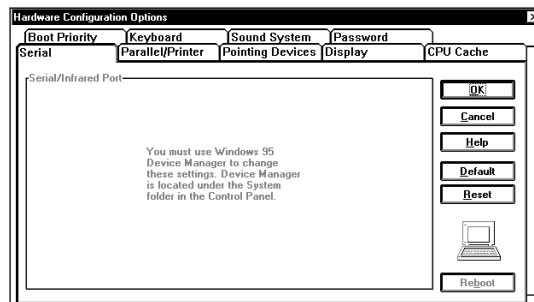

The Hardware Configuration Options dialog box

4 Click the Keyboard tab.

Hardware Setup displays a page with the Int. Keyboard Key Layout option.

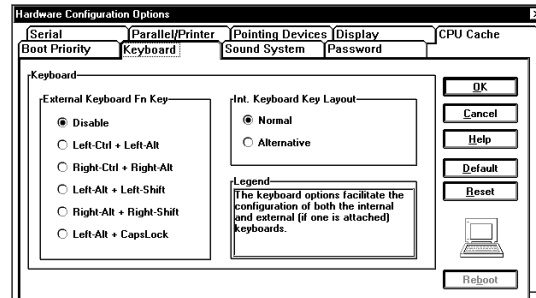

The Keyboard page

5 Click the circle to the left of the desired Int. Keyboard Key Layout setting.

Normal is the default setting.

6 Choose OK.

Hardware Setup displays a dialog box asking if you want to reboot (restart) the computer.

7 Choose:

- ❖ Yes to restart the computer immediately with your changes in effect.
- ❖ No, if you have programs open with unsaved files. Save your files and restart the computer using the reset button or Ctrl + Alt + Del to make your changes take effect.

Using Device Manager to Configure Your System

The Windows 95 Device Manager lets you set up many of the individual components of your system. You'll need to use it if, for example, you want to change the COM port name assigned to the serial port or the range of memory reserved for the display adapter. This section gives a brief overview of how to use Device Manager.

To change a component's setting in Device Manager, follow these steps:

- 1 **Click on the My Computer icon with the secondary button, then click Properties.**

Windows 95 opens the System Properties sheet.

- 2 **Click on the Device Manager tab.**

The System Properties sheet moves to the Device Manager page.

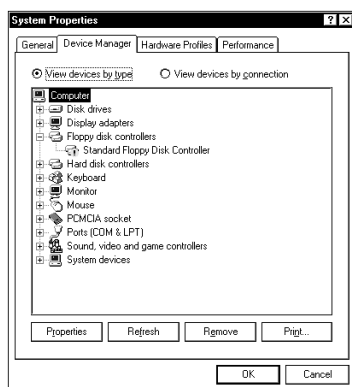

The Device Manager

This page lists all of the components of the system that you can change through Device Manager.

- 3 **Double-click on the type of device you want to modify.**

For example, if you want to modify the serial port settings, double-click on Ports.

Device Manager extends the branch, showing all devices of the type you chose.

- 4 **Double-click on the device you want to modify.**
- 5 **Click the Resources tab to move to the Resources page.**

6 Make the desired changes.



NOTE

If you're unused to working with the computer's configuration, it's a good idea to leave the Use Automatic Settings box checked. These settings were set to work together within the system and with most available optional devices.

7 Click OK when you've finished your changes.

Different Ways to Turn the Computer On and Off

Now that you've mastered turning your computer on by pressing the power button, it's time to learn some new tricks. This section explains how to:

- ❖ set the computer to turn on automatically at a time you choose (the Alarm Power On option). This option is helpful if you are expecting to receive files by modem and want to do the transfer at night, when the rates are cheaper. You can set the computer to turn on and receive the files while you are asleep.
- ❖ turn the computer on and off by opening and closing the display panel (the Panel Power On/Off option). This option not only makes it easier to turn the computer's power on, but makes it impossible to close the display panel while the computer is on. This option is only available if you turn Resume Mode on.
- ❖ set the computer to turn off automatically after a set amount of time in which no computing activity has occurred (the System Auto Off option). This option is only available if you turn Resume Mode on.

You can set the Alarm Power On, Panel Power On/Off and System Auto Off options using either MaxTime or TSETUP. This section shows you how to change the options using MaxTime. For information on using TSETUP, refer to "TSETUP" on page 341.

Follow these steps to set the Alarm Power On and Panel Power On/Off options:

- 1 Click **Start**, then point to **Programs**.
- 2 Point to **Toshiba Utilities**, then click **MaxTime**.

MaxTime displays the battery gauge window.



The MaxTime battery gauge window

- 3 Choose **Machine Settings** from the **Options** menu.

MaxTime displays the Machine Settings dialog box.

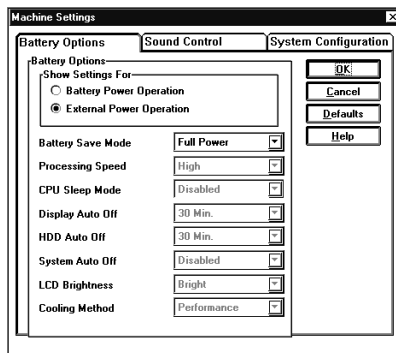

The Machine Settings dialog box

- 4 Switch to the **System Configuration** page by clicking the **System Configuration** tab.

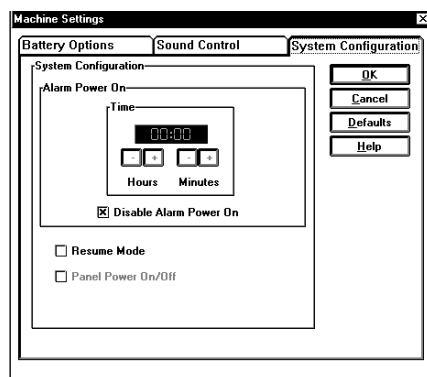

The System Configuration page

- 5 To turn on the computer at a particular time, click the checkbox next to **Disable Alarm Power On**.**

This box is blank when Alarm Power On is turned on. Choose the Alarm Power On Time Format you wish to use, then click the + and - buttons until the Time field displays the time at which you want the computer to turn on.

An X in the checkbox turns off the Alarm Power On feature.

- 6 To set the computer to turn on or off when you open or close the display panel, click the checkbox next to **Panel Power On/Off**.**

This option is only available if Resume Mode is turned on.

- 7 Choose OK to exit the dialog box and save your changes.**

Changing the Display Mode

Perhaps you would like to change how much information your screen displays, or adjust the number of colors it uses. You can control these options by using the screen display program. Any changes you make using this program affect Windows 95 only and will not change how your screen looks in DOS.

To open the program, follow these steps:

- 1 Click Start, then point to Settings.**

2 Click Control Panel.

Windows 95 displays the Control Panel.

3 Double-click the Display icon.

Windows 95 opens the Display Properties sheet.

4 Click the Settings tab to move to the Settings page.

5 Change the number of colors the display can show by changing the Color palette setting.



Setting the palette to High Color (16-bit) provides 64k colors. True Color (24-bit) provides 16 million colors. Some color modes and resolutions are available only on an external monitor. See "Video Modes" on page 391 for the modes available on the internal display.

6 Change the screen resolution by clicking and dragging the Desktop area slider.

7 To change your monitor type, click Change Display Type, set the new monitor type and click Change.

8 When you've made all your changes, click OK.

To close the Display Properties sheet without enabling your changes, click Cancel.

The internal display uses virtual display modes to simulate resolutions beyond its capacity. In a virtual display mode, the display shows all of the screen image it can. To see the rest of the screen image, scroll down and to the right.

What's Really Going On?

By now, you've probably become pretty good at using your computer. However, you may be curious as to what is really going on while you're pounding away at the keyboard. This chapter gives you details of how your computer works.

What Is a Computer?

In one sense, your Satellite 200 Series is a computer. Technically speaking however, the processor chip, where the actual computing takes place, is the computer. All the other components are outside the computer because they either provide information to the processor or receive the results of the processor's computations.

What Other Batteries Does the Computer Have?

In addition to the main battery that powers your system when you're away from an AC outlet, your Satellite 200 Series computer has two other batteries:

- ❖ The backup battery supports resume mode. When you turn the computer off in Resume Mode, a special memory powered by

the backup battery keeps track of everything for the next time you turn the computer on. The backup battery gets its charge from the main battery.

- ❖ The RTC (real-time clock) battery stores the computer's configuration information, which is stored in the RTC memory. When you make changes in TSETUP or Hardware Setup, this memory keeps track of those settings. The RTC battery also operates the computer's internal clock.

The main battery charges the RTC battery.

How Does a Disk Store Information?

Like a tape recorder, a disk drive reads and writes magnetically encoded information on magnetic media. The drive positions a read/write head above the surface of the disk when it records and retrieves information.

Before a drive can read from or write to a disk, the disk must have a specific structure. Formatting a disk creates this structure.

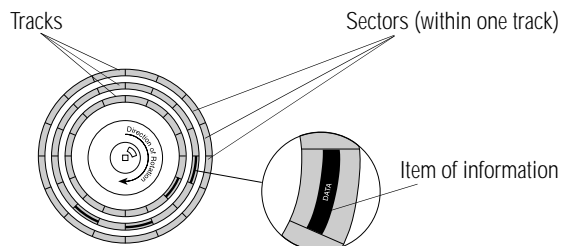

Tracks and sectors of a disk

Formatting divides each side of the disk into concentric circles called tracks. Each track is divided into sectors. Each item of information stored on a disk has a specific address composed of its side, track and sector number. This address makes it possible for the computer to locate the information on the disk.

How Big Is a Megabyte, Anyway?

When you read about the size of your hard disk, you may be confused by the discrepancy between megabytes and millions of bytes. “Wait a minute,” you say, “doesn’t a megabyte equal one million bytes?” Well, not exactly...

Computers use base two arithmetic, also called binary arithmetic. Because of this, all numbers in computing are based on powers of two. One megabyte is actually equal to 1,048,576 bytes (2^{20}), the closest binary number to 1,000,000.

In the early days of personal computers, the difference was very minor because hard disks were small and computers didn’t have much memory. As hard disk capacities and memory sizes have increased, the difference has become much more significant.

The hard disk that comes with the Satellite 200 Series computer holds approximately 772 megabytes. You can convert this to millions of bytes by multiplying the number of megabytes (772) by the number of bytes in a megabyte (1,048,576). The result is 809,500,672, approximately 810 million bytes.

How Does the Screen Display Information?

Images on the Satellite 200 Series computer's built-in liquid crystal display (LCD) are created by turning individual dots on the screen on or off in various combinations. These dots are called pixels.

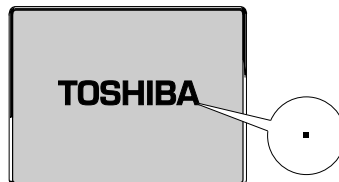

A pixel on the display

A pixel is the smallest element on the screen. On a color display, each pixel is made up of three subpixels: one red, one green and one blue (RGB). Each subpixel may be either on or off. Mixing on

and off subpixels is like blending the primary colors to create other colors.

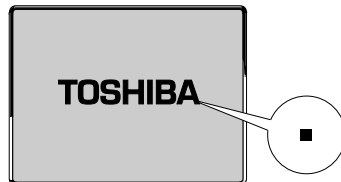

A pel formed by several pixels

The smallest element that your programs can control is called a pel. Pels are arranged on the screen in a grid-like fashion. Depending on the video mode a program selects, a pel may be a single pixel or several pixels.

The pel size determines the clarity of the image—called screen resolution. Larger individual pels reduce the total number of available pels, resulting in lower resolution. Smaller pels increase the number of pels that can fit on the screen, resulting in higher resolution and a clearer image.

Displaying Colors

The pel size also determines how many colors the display can produce. By combining pixels of different colors within a pel, the display can produce many more colors than are available within a single pixel. Therefore, larger individual pels increase the number of colors available to the display.

Video Modes

Video modes are sets of industry-standard rules about resolution and the maximum number of distinct colors that can be displayed simultaneously on the screen. Programs that adhere to the rules of a video mode will run on any system that supports that mode.

Most display adapters provide several video modes. The computer's SVGA-compatible display adapter supports all VGA modes and some SVGA modes.

The video mode required by a program depends on:

- ❖ whether the program displays graphics or text.
- ❖ the resolution required for the text or graphics.
- ❖ the number of colors used.
- ❖ the font size (in pixels) of the text.

Based on these requirements, computers recognize two categories of video modes: graphics modes and text modes.

In a graphics mode, programs can turn on and off individual pels to display a variety of images. The computer controls every pel on the screen individually. This provides maximum display flexibility while somewhat reducing the speed at which the display produces images.

An image produced this way could be a drawing or picture, like a pie chart, graph or photograph. It could also be an icon or a variation on a text character, like italics or bold type.

Windows 95 and Windows programs use graphics modes.

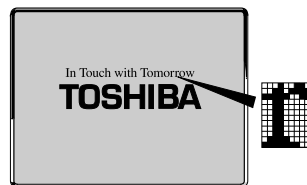

Character cell in a text mode

In a text mode, a character cell is the smallest element a program can control. A character cell is a grid of pels. All cells are the same size. Each cell displays a single letter or symbol. Character cells are arranged in rows and columns. In a text mode, only characters from a predefined set are available. If your program uses a text mode, refer to the program's documentation for a list of available characters.

What Is Plug and Play?

Plug and Play is a clever name for a new technology developed jointly by Intel and Microsoft that seeks to make upgrading a computer system easy.

Computer systems, such as the Satellite 200 Series, operating software and add-on products that are designed according to this standard work together the first time you connect them. Plug and Play eliminates the time-consuming frustration of figuring out which IRQ and memory addresses to assign.

Since Plug and Play is an important part of Windows 95, your Satellite 200 Series computer lets you take advantage of all its features.

What Really Happens When You Turn the Computer On?

When you press the power button, the following occurs:

1 The computer's BIOS (Basic Input/Output System) loads a bootstrap program.

This program, named from the expression “pull yourself up by your bootstraps,” checks and displays the amount of memory in the system before proceeding.

2 The bootstrap program attempts to load Windows 95.

It looks first for a diskette in the diskette drive and then at the hard disk. If a diskette without the necessary startup files is in the drive, the bootstrap program displays an error message.



NOTE

If you've changed the Boot Priority option in TSETUP, the computer will check the hard disk before the diskette drive.

3 As Windows 95 loads, it configures the system.

4 Windows 95 loads the desktop.

If Something Goes Wrong

Some problems you may encounter when using the Satellite 200 Series computer are relatively easy to identify and solve. Others may require help from your dealer or the manufacturer of a software program.

The goal of this chapter is to help you solve many problems on your own before you need to seek additional help. To begin, read the chapter headings on the opposite page, then turn to a section that sounds like the kind of problem you are having. Each section describes a problem and provides a solution. Read the section and see if it describes your problem. If so, follow the steps. Remember, not every problem can be described in this chapter, but this is a good place to start.

If all else fails, contact Toshiba at (800) 999-4273. If you are calling from outside the U.S., dial (714) 859-4273. The end of this chapter details all the pertinent information for Toshiba's support services.

Start with the Easy Problems

The more you work with your computer, the more likely you are to encounter one or more of the following problems. Don't panic! You can resolve them relatively easily.

Your program stops responding

If you are working with a program that suddenly freezes all operations, chances are the program has stopped responding. Don't worry. You can exit the failed program without shutting down Windows 95 or closing other programs.

To close a program that has stopped responding, follow these steps:

1 Press Ctrl + Alt + Del once.

Windows 95 displays the Close Program dialog box. The box lists all the programs and processes currently in operation. If a program has stopped responding, the words "not responding" appear beside its name in the list.

2 Select the program you want to close, then click End Task.

Closing the failed program should allow you to continue working. If it does not, follow these steps:

3 Close the remaining programs by clicking End Task.

4 Click Shut Down.

The Shutdown window displays.

5 Select Restart, then click Yes.

Your computer shuts down and restarts Windows 95, thus restoring operations.



Unless all else fails, don't press Ctrl + Alt + Del twice to restart your computer. Closing all open programs prior to shutting down Windows 95 ensures that all data is saved.

Your program performs an illegal operation

If you receive the message, “Your program has performed an illegal operation,” you should record the details of the message and consult the software manufacturer.

To record the details:

- 1 Click the Details button and select the text Windows 95 displays.**

The Details button displays information that the software manufacturer needs to help you solve your problem.

- 2 Press Ctrl + c to copy the text to the clipboard.**
- 3 Open Notepad by clicking the Start button and pointing to Programs, Accessories, and clicking Notepad.**
- 4 Press Ctrl + v to paste the details into Notepad.**
- 5 Add a paragraph break and type some notes describing what you were doing when you received the message.**
- 6 Save the file and refer to it when you contact the software manufacturer.**

You receive a “Non-System Disk” error message

A disk is in the diskette drive while the computer is starting Windows 95. Remove the disk from the drive and press any key to continue.

You open a program that immediately stops responding

If CPU sleep mode is on (enabled), it may stop a program from responding. Close the program you are trying to open and turn off (disable) sleep mode. Then, try to run the program again.

To close the program:

- 1 Press Ctrl + Alt + Del.**

The Close Program dialog box displays all the programs and processes currently in operation. If the program has stopped responding, the words “not responding” appear beside it.

2 Click End Task, then click Cancel.

You disable sleep mode in MaxTime or TSETUP. Follow these steps to disable sleep mode using MaxTime:

3 Click Start, then point to Programs.

4 Point to Toshiba Utilities, then click MaxTime.

MaxTime displays the MaxTime battery gauge window.

5 Select Machine Settings from the MaxTime Options menu.

MaxTime displays the Machine Settings dialog box.

6 Click Battery Options.

MaxTime displays the battery options.

7 Set the Battery Save Mode to User Settings.

8 Select Disabled for Sleep Mode.

9 Select OK or press Enter to save your changes and exit the dialog box.

10 Minimize MaxTime or close the program by choosing Exit from the File menu.

You don't have to restart the computer for this change to take effect.

If the problem continues, contact the manufacturer of the program.

Problems Turning the Computer On

These problems might occur when you turn the power on.

The computer won't start.

Make sure you attached the power cord properly or installed a charged battery. Press and hold the power button for a few seconds.

The computer starts, but when you press a key on the key-

board or touch the AccuPoint, nothing happens.

You are probably in Resume Mode and have a software or resource conflict. When this happens, turning the power on returns you to the problem instead of restarting the system. To clear the condition, press Ctrl + Alt + Del or press the reset button.

Clearing the condition may get you running by disabling Resume Mode, but it won't solve a resource conflict. Read the documentation that came with the conflicting device and "What to do with a Hardware Conflict" on page 277.

Windows 95 Isn't Working

Once you are familiar with the desktop and comfortable with the way Windows 95 responds to your work routine, you can easily detect if Windows 95 isn't working correctly. A problem causes a break in routine operations.

Unless a device has failed, problems usually occur when you change the system configuration, add a device, install a new program, or do something that changes the system's established routine. As a result, one of the following problems may occur.

- ❖ Windows 95 fails to start after the Starting Windows 95 message displays.
- ❖ Windows 95 takes a long time to start.
- ❖ Windows 95 responds differently from the normal routine.
- ❖ Your display doesn't look right.

If you experience any one of these problems, use the startup options in the Windows 95 Startup Menu to fix the problem.

Using Startup Options to Fix Problems

If Windows 95 fails to start properly, you may have to change your system's configuration or verify the startup procedure to fix the problem. To do this, use the startup options in the Windows 95 Startup menu. The following section describes each startup option and when to use the procedure.

To open the Windows 95 Startup menu:

- 1 Restart your computer.**
- 2 Press F8 when your computer starts.**

The Windows 95 Startup Menu displays the following options:

- ❖ Normal
- ❖ Logged (\BOOTLOG.TXT)
- ❖ Safe Mode
- ❖ Step-by-Step Confirmation
- ❖ Command Prompt Only
- ❖ Safe Mode Command Prompt Only



NOTE

If your computer is connected to a network, the Startup Menu may display different versions of Safe Mode.

Normal

Selecting Normal starts Windows 95 under normal conditions. Start the computer in Normal mode when there are no apparent problems with the system.

Logged (BOOTLOG.TXT)

Selecting Logged starts Windows 95 under normal conditions and creates a hidden startup log file named C:\BOOTLOG.TXT. This file records every step of the system's startup process. You can view this file through Explorer by setting the View Options to View All Files.

You or a Windows 95 expert can use this log file to check the loading and initializing of Windows 95 device drivers.



A device driver is a file that contains information to help the computer's BIOS (Basic Input/Output System) control operations of devices connected to the system.

Safe Mode

Selecting Safe Mode bypasses basic startup files and starts Windows 95 with only the mouse, keyboard, and standard VGA display drivers loaded.

Running Safe Mode allows you to undo any changes you made to the system configuration that may have caused Windows 95 or a device to fail. For example, if you choose a resolution that is not supported by the display, Windows 95 will have a problem starting correctly. Safe Mode bypasses the setting and allows you to change the resolution to one supported by the display. Once changed, Windows 95 will start correctly. Other problems may involve a device driver. See “Windows 95 Can Help You” on page 277 to fix the problem.



Windows 95 automatically starts in Safe Mode if it detects that system startup failed or the Windows 95 Registry (the file that defines how Windows 95 is set up) is corrupted.

Step by Step Confirmation

When you turn your computer on, Windows 95 processes the startup directory. By selecting Step by Step Confirmation, the system asks you to confirm each line of the startup process once it displays. Use this option when:

- ❖ The startup process fails while loading the startup files.

- ❖ You need to verify all drivers are being loaded.
- ❖ You need to temporarily disable one or more specific driver.
- ❖ You need to check for errors in the startup files.

Windows 95 uses a file called IO.SYS, which contains all the information needed to start the computer. Although your computer does not need the CONFIG.SYS and AUTOEXEC.BAT files to start, it does process these files to support backward compatibility with some programs and device drivers. The same holds true for the SYSTEM.INI and WIN.INI files.



Programs and devices that are backward compatible are designed to work with older operating systems and other programs. For example, many features of Windows 95 are backward compatible with earlier versions of Windows. This lets you use older programs in Windows 95.

Most of the information contained in these files is now stored in the Windows 95 Registry. However, they are still processed during system startup. BOOTLOG.TXT file contains a record of all the components and drivers loaded during startup and the status of each. When you select Step by Step Confirmation, you can view all the startup files one line at a time to help diagnose the source of a problem.

Command Prompt Only

Selecting Command Prompt Only runs all the commands in the startup files (AUTOEXEC.BAT and CONFIG.SYS) and displays the command prompt.

Use this option when you want to run MS-DOS or Windows 95 commands. This option is for advanced user's who are familiar with MS-DOS and know what these commands do.

Safe Mode Command Prompt Only

Selecting Safe Mode Command Prompt Only bypasses the system startup files and displays the command prompt.

Use this option under the following conditions:

- ❖ Windows 95 fails to start even in Safe Mode.
- ❖ You want to run MS-DOS commands such as edit to make changes to your startup files.
- ❖ You want to avoid loading HIMEM.SYS (extended memory manager), or IFSHLP.SYS (file system manager).

Windows 95 Can Help You

If Windows 95 has started properly, but you still have a problem using your computer, Windows 95 Help can help you solve the problem. Follow these steps:

- 1 Click the Start button and click Help.**
- 2 Click the Contents tab and double-click Troubleshooting.**
- 3 Double-click a problem you would like help with, and follow the steps.**

What to do with a Hardware Conflict

If you receive an error message telling you there is a device driver conflict or a general hardware problem, try using Windows Help to solve the problem first.

- 1 From the Windows Help menu, click the Contents tab and select Troubleshooting.**
- 2 Click “If you have a hardware conflict” and follow the steps.**

If there is still a problem, for example, if one of your devices isn't Plug-and-Play, Windows 95 may display a message that explains where the conflict is. Use Device Manager, following the steps in “Fixing a Problem with Device Manager” on page 280, to deter-

mine the resource assignments for each device and to resolve the conflict.

A Plan of Action

The smooth operation of the system depends on the interaction of all devices, programs and features. If the system or one of its attached devices isn't working, resolving the problem can be time-consuming and frustrating.

The recommended procedure for getting multiple devices to work together is to add and set up one device at a time. After you add each device, test it to make sure it and all previously connected devices work.

Chances are the device most recently connected to the system is the one causing the conflict.



NOTE

A word to the wise: if you get too tired and frustrated, take a break. You'll be surprised how different things look when you've had a chance to relax.

Resolving Hardware Conflicts on Your Own

Just as a business person needs a telephone and a computer to get the job done, so also computer components need resources to accomplish a task. A device, such as a CD-ROM drive or a modem, needs a channel to the computer's Central Processing Unit (CPU). It also needs a direct channel to the computer's memory to store information as it works. These channels of communication are commonly referred to as system resources.

The channel to the CPU is called an Interrupt ReQuest (IRQ) because it interrupts what the processor is doing and requests some of the processor's time. If two or more devices use the same IRQ, the processor doesn't know which device is asking for attention. This causes a problem.

Similarly, the data required by the device is stored in a specific place or address in memory called the Direct Memory Address (DMA). If two or more devices use the same DMA, the data required by one device overwrites the data required by the other. If either of these situations occur, you have a hardware conflict.

With Plug and Play and Windows 95, avoiding hardware conflicts is easy. Plug and Play is a type of computer standard present in your computer that helps the system BIOS (basic input/output system), Windows 95 and a Plug and Play-compliant devices work together to automatically assign system resources to the device. In theory, if every device connected to the computer is Plug and Play-compliant, no two devices would compete for the same system resources. You simply plug in the device and turn your computer on. Windows 95 automatically sets up your system to accommodate the new device.

However, if you install an older device that Windows 95 cannot recognize, Windows 95 may have difficulty assigning system resources to it. As a result, a hardware conflict can occur. To see what resources Windows 95 has assigned to the device, See “Checking Device Properties” on page 281. If Windows 95 is unable to provide the information you need, the pre-assigned settings for IRQs, DMAs and I/O assignments are listed in “System Resources” on page 383 for your reference.

There are three things you can do to resolve hardware conflicts.

❖ Disable the device.

For an older device, remove it from the computer. For a Plug and Play device, see “Fixing a Problem with Device Manager” on page 280.

❖ Disable another system component and use its resources for the new device.

See “Fixing a Problem with Device Manager” on page 280.

❖ Reconfigure the device so its requirements do not conflict.

Refer to the device’s documentation for instructions about changing settings on the device.

Fixing a Problem with Device Manager

Device manager provides a way to check and change the configuration of a device.



Using Device Manager to change the default settings can cause other conflicts that make one or more devices unusable. Device Manager is a tool for advanced users who understand configuration parameters and the ramifications of changing them.

Disabling a Device in Windows 95

To disable a device, follow these steps:

- 1 Click the My Computer icon with the secondary button, then click Properties.**

Windows 95 displays the System Properties dialog box.

- 2 Click the Device Manager tab.**
- 3 Double-click the device type to display the device installed.**
- 4 Select the device and click Remove.**

A warning message asks you to confirm the device removal.

- 5 Click OK.**

Checking Device Properties

Device Manager provides a way to view the properties of a device. Properties include the name of the manufacturer, the type of device, the drivers installed, and the system resources assigned to the device. To check a device's properties follow these steps:

- 1 Click the My Computer icon with the secondary button, then click Properties.**

Windows 95 displays the System Properties dialog box.

- 2 Click the Device Manager tab.**
- 3 To view the device installed, double-click the device type.**
- 4 To view the properties, double-click the device.**

Windows 95 displays the Device Properties dialog box, which provides up to three tabs to choose from:

- ❖ The general tab provides basic information about the device.
- ❖ The Resources tab lists the resources assigned to the device. If you have a device conflict, it displays in the Conflicting device list.

- ❖ The Drivers tab displays the drivers being used by the device.

For further information about Device Manager, refer to Windows 95 on-line help.

Fixing Device Related Problems

If you don't have a hardware conflict, but you think your problem could be related to one of your computer's devices, the first thing to do is run a system verification test. A system verification test confirms that all the devices connected to the computer are working. This includes testing the memory, hard disk, diskette drive, display, and additional devices you may have connected to the system.

After running the test, read the rest of this section that describes problems and solutions related to specific devices.

Running the System Verification Test

To verify the system, follow these steps:

- 1 Turn the computer off.**
- 2 Hold the spacebar as you press the power button.**

If Resume Mode is on, hold the spacebar as you press the reset button.

System verification displays the following message for a few seconds as the computer tests memory:

```
(C) Copyright 19>.xx Toshiba Corp. All rights reserved.  
MEMORY TEST .xxxKB
```

Successful Test Results

If the system verifies that all components connected to the system are working properly, the computer beeps once then starts Windows 95.

Unsuccessful Test Results

If the system verification test fails, the computer does one of the following:

- ❖ Stops updating the memory counter and does not proceed to display information or messages.
- ❖ Beeps once but displays no new messages.
- ❖ Displays random characters and does not function normally.
- ❖ Displays an error message.

Verify the system again. Before you do so, turn the computer off and make sure all optional devices are connected properly. If the test fails a second time, you have demonstrated that you can reproduce the problem and it's time to contact a trained technician.

Other Circumstances

The computer normally beeps at the conclusion of a successful system verification. If the system speaker is set to Disabled in MaxTime or TSETUP, this beep will not occur.

If the speaker is turned on (enabled) and the system verification completes but you don't hear a beep, the speaker may be faulty. Though this does not affect the computer's operation, you may wish to contact your dealer and have it repaired.

If the system verification is successful but the operating system won't load, refer to "Problems Turning the Computer On" on page 272. If all seems correct, treat this as a hardware error and contact your dealer.

Where Do I Go from Here?

If you determined that you have a problem with a specific device, the following section lists problems related to specific devices and offers some solutions.

| | |
|------------------------------|----------|
| Start with the Easy Problems | page 270 |
| Power and the Batteries | page 285 |

| | |
|------------------|----------|
| The Keyboard | page 285 |
| The Display | page 287 |
| The AccuPoint | page 286 |
| The Disk Drives | page 287 |
| Optional Devices | page 289 |
| PC Cards | page 290 |
| Printers | page 293 |
| Modems | page 294 |

Memory Card Problems

Bad or improperly connected memory cards may also cause problems with Windows 95. To check your memory card:

1 Click Start, then click Shut Down.

Windows 95 displays the Shut Down Windows dialog box.

2 Click the button next to Shut down the computer, then click Yes.

Windows 95 shuts down and turns the computer off automatically.

3 Remove the memory card.

4 Reinstall the memory card, making sure it's seated properly.

5 Replace the memory expansion slot cover.

6 Check for the error again.

7 If the error reoccurs, remove the memory card entirely and check for the error again.

If removing the memory card eliminates the error, the memory card may be bad. If the error reoccurs without the memory card installed, the error is not caused by the memory card.

Power and the Batteries

Your computer receives its power through the built-in power supply and power cord or from the system batteries (main battery, real-time clock (RTC) battery and backup battery). Power problems are interrelated. For example, a bad power cord will neither power the computer nor recharge the batteries.

Here are some typical problems and how to solve them:

The power light doesn't come on when you plug in the power cord.

Make sure the power cord is firmly plugged into both a working wall outlet and the computer.

The power cord works correctly, but the battery won't charge.

The main battery may not be inserted correctly in the computer. Turn off the computer, remove the battery, clean the battery contacts with a soft, dry cloth and replace the battery.

The battery appears not to power the computer for as long as it usually does.

Check the power-saving features in MaxTime or TSETUP. Have you added a device, such as a PC Card or memory module, that takes its power from the battery? Is your software using the hard disk more? Is the display power set to turn off automatically? Was the battery fully charged to begin with? All these conditions affect how long the charge lasts.

For more information on maximizing battery power, refer to "Looking After Your Battery" on page 143 and "Conserving Power" on page 138.

The Keyboard

If, when you type, strange things happen or nothing happens, the problem may or may not be related to the keyboard itself.

The keyboard produces unexpected characters.

A keypad overlay may be on. If the numeric keypad or cursor control light is on, press Fn + F10 to turn off the cursor control light or Fn + F11 to turn off the numeric keypad light.

Make sure the programs you are using are not reassigning keys to other characters.

You've connected an external keyboard and Windows 95 displays one or more keyboard error messages.

If you have a second keyboard, try it. If it works, the first keyboard may be defective or incompatible with your computer.

Nothing happens when you press the keys on the external keyboard.

You may have plugged the external PS/2 keyboard in while the computer was turned on. Press Ctrl + Alt + Del or press the reset button to restart the computer so it recognizes the device.

Make sure the PS/2 keyboard is plugged into the PS/2 keyboard port and not the PS/2 mouse port on the optional NoteDock™.

Typing on the keyboard has no effect and the computer will not restart.

Make sure the power is on and press the reset button.

The AccuPoint

Some of the keyboard conditions listed above may affect the AccuPoint. In addition, consider the following:

Your finger easily slides off the AccuPoint.

The AccuPoint cap may be oily. Remove the cap and clean it with a cotton swab dipped in rubbing alcohol.

Or the cap may have become worn. Replace the cap with one of the spares that came with your computer. Refer to "Replacing the AccuPoint Cap" on page 108 for instructions.

The Display

Here are some typical display problems and their solutions:

The display is blank.

Display Auto Off may have gone into effect. Press any key to activate the screen.

You may have activated the instant security feature by pressing Fn + F1. Enter your password if you have registered one, or press Enter to return to work.

The display doesn't look right.

See "Changing the Display Mode" on page 257 to adjust your screen resolution or color settings.

The built-in screen flickers.

Some flickering is a normal result of the way the screen produces colors. To reduce the amount of flickering, try using fewer colors.

Windows 95 displays a message that there is a problem with your display settings and that the adapter type is incorrect or the current settings don't work with your hardware.

Reduce the size of the color palette to one that is supported by the computer's internal display. See "Changing the Display Mode" on page 257 for instructions.

The Disk Drives

Problems with the hard disk or with a diskette drive usually show up as an inability to access the disk or as sector errors. Sometimes a disk problem may cause one or more files to appear to have garbage in them. Typical disk problems are:

You are having trouble accessing a disk, or one or more files appear to be missing.

Make sure you're identifying the drive by its correct name (A or C).

Run ScanDisk, which analyzes the directories, files and File Allocation Table (FAT) on the disk and repairs any damage it finds. To run ScanDisk, follow these steps:

- 1 Click Start, then point to Programs.**
- 2 Point to Accessories, then point to System Tools.**
- 3 Click ScanDisk.**

Windows 95 opens the ScanDisk window.

- 4 Click the drive you want to test.**
- 5 Choose the type of test you want to use.**

A thorough test is more complete but takes much more time than a standard test.

- 6 Click Start.**

ScanDisk tests the disk.

Your data files are damaged or corrupted.

Refer to your software documentation for file recovery procedures. Many software packages automatically create backup files.

You may also be able to recover lost data by using a disk utility program, which is available from your dealer.

A diskette won't go into the diskette drive.

You may already have a diskette in the drive. Make sure the drive is empty.

You may be inserting the diskette improperly. Hold the label of the diskette with the hub side facing down, and insert it so the metal head window cover goes into the drive first.

The metal cover or loose labels may be obstructing the path into the drive. Carefully inspect the diskette. If the metal cover is loose, replace the diskette. If the label is loose, replace the label and try inserting the diskette again.

The computer displays the Non-system disk or disk error message.

If you're starting the computer from the hard disk, make sure there's no diskette in the diskette drive.

If you're starting the computer from a diskette, the diskette in the drive doesn't have the files necessary to start the computer. Replace it with a startup disk, such as the one you created when you ran the Microsoft Create System Disks program.

A diskette won't format properly.

Make sure you've chosen the correct disk capacity in the Format dialog box. You can't format double-density diskettes as high-density diskettes and vice versa.

Try using a different diskette. If the computer completes the formatting of the new diskette, run ScanDisk, following the steps on page 288, to check the new diskette. If the drive formats properly and ScanDisk doesn't report any errors during the test, the problem is probably a faulty diskette.

The drive can't read a diskette.

Try another diskette. If you can access the second diskette, the first diskette (not the disk drive) is probably causing the problem. Run ScanDisk, following the steps on page 288, on the faulty diskette.

If the problem occurs with each diskette you attempt to access, run the diagnostic test to check the diskette drive. Refer to "The Diagnostic Test" on page 357.

Optional Devices

Optional devices can include a printer, PC Cards, an external monitor, or any other device you connect to your computer to expand its capabilities. This section begins with some general comments and continues with sections for specific devices.

PC Cards

Most PC Card problems occur during installation and setup of new cards. If you're having trouble getting one or more of these devices to work together, several sections in this chapter may apply.

- ❖ Resource conflicts can cause problems when using PC Cards. Refer to “What to do with a Hardware Conflict” on page 277.
- ❖ If the device is a modem, see “Modems” on page 294.

Card Information Structure

When you insert a PC Card into a slot, the computer attempts to determine the type of card and resources it requires by reading its Card Information Structure (CIS). Sometimes the CIS contains enough information for you to use the card immediately. Other cards must be set up before you can use them.

Use the Windows 95 PC Card (PCMCIA) Wizard to set up the card. See “Setting Up PC Card Support in Windows 95” on page 178 for information about the PC Card Wizard.

Some card manufacturers use special software called enablers to support their cards. Enablers result in nonstandard configurations that can cause problems when installing another PC Card.

If Windows 95 doesn't have built-in drivers for your PC Card and the card didn't come with a Windows 95 driver, it may not work under Windows 95. Contact the manufacturer of the PC Card for information about operating the card under Windows 95.

PC Card Checklist

- ❖ Make sure the card is inserted properly into the slot.
Refer to “Inserting PC Cards” on page 176 for how to insert PC Cards.
- ❖ Make sure all cables are firmly connected.
- ❖ Make sure the computer is loading only one version of Card and Socket Services.

- ❖ Every once in a while a defective PC Card slips through quality control. If another PCMCIA-equipped computer is available, try the card in that machine. If the card malfunctions again, it may be defective.

Resolving PC Card Problems

Here are some common problems and their solutions:

The slots appear to be dead. PC Cards that used to work no longer work.

Follow these steps to view the PC Card status:

- 1 Click the My Computer icon with the secondary button, then click Properties.**

Windows 95 displays the System Properties dialog box.

- 2 Click the Device Manager tab.**

- 3 Double-click the device listed as your PC Card.**

Windows 95 displays your PC Card's Properties dialog box. This dialog box contains information about your PC Card configuration and status.

The computer stops working (hangs) when you insert a PC Card.

The problem may be caused by an I/O (input/output) conflict between the card and another device in the system. Use Device Manager to make sure each device has its own I/O base address. See "Fixing a Problem with Device Manager" on page 280 for more information.

The PCMCIA socket should have its own I/O base address. Since all cards share the same socket, each card is not required to have its own address.

Hot swapping (removing one PC Card and inserting another without turning the computer off) fails.

Follow this procedure before you remove a PC Card:

- 1 Click the PC Card icon on the taskbar.**
- 2 Click Stop xxxx, where xxxx is the identifier for your PC Card.**

Windows 95 displays a message that you may safely remove the card.

The system does not recognize your PC Card or PCMCIA socket controller.

Often removing a malfunctioning card, inserting it again, and reinstalling it using the procedure in “Setting Up PC Card Support in Windows 95” on page 178 can correct many problems.

There is still a yellow exclamation point (!) over the PCMCIA controller icon in Device Manager.

You’ve gone through the PCMCIA Wizard in Windows 95 as described in “Setting Up PC Card Support in Windows 95” on page 178, but the system still reports the controller with a yellow!.

Your computer may not be firmly attached to the optional NoteDock. To fix the connection:

- 1 Click Start, then click Shut Down.**

Windows 95 displays the Shut Down Windows dialog box.

- 2 Click the button next to Shut down the computer, then click Yes.**

Windows 95 shuts down and turns the computer off automatically.

- 3 Lift the locking latch on the NoteDock.**
- 4 Gently lift the computer and slide it off of the NoteDock.**
- 5 Reconnect the computer and NoteDock, making sure to press them together firmly.**

Refer to “Connecting the Computer to the NoteDock” on page 226 for instructions.

Printers

This section lists some of the most common printer problems.

The printer won't print.

- ❖ If your printer is ECP- or IEEE 1284-compliant, make sure you have an IEEE 1284 printer cable.
- ❖ Make sure the printer is connected to power and the printer itself is ready (on line).
- ❖ Make sure the data cable between the computer and the printer is firmly attached at both ends.
- ❖ You may have connected the printer with the computer on. Disable Resume Mode, turn off the computer, and turn off the printer. Turn the printer back on, make sure it is on line, then turn the computer back on.
- ❖ Try printing another file. For example, you could create and attempt to print a short test file using Notepad. If a Notepad file prints correctly, the problem may be in your original file.
- ❖ Check the printer port and driver. Click Start, Settings, then Printers. Next, click on the icon for your printer using the secondary mouse button and click Properties in the menu list. Finally, click the Details tab and confirm that the port and driver options are correct.
- ❖ Sometimes it helps to delete the printer and install it again. Click Start, Settings, then Printers. Click your printer using the secondary mouse button and click Delete in the menu list. Follow the instructions in “Setting Up Windows 95 to Work with Your Printer” on page 87 to install the printer again.

The printer won't print what you see on the screen.

Many programs display information on the screen differently from the way they print it. See if your program has a print preview

mode. This mode lets you see your work exactly as it will print. Contact the software manufacturer for more information.

Modems

A modem, fax/modem or fax/voice/modem is a serial device. This section lists common modem problems.

The modem won't receive or transmit properly.

Make sure the RJ-11 cable (the one that goes from the modem to the telephone line) is firmly connected to the modem's RJ-11 jack and the telephone line socket.

Check the serial port settings to make sure the hardware and software are referring to the same COM port (in Device Manager under Modems for PC Card modems under Ports for an external modem).

Check the communications parameters (baud rate, parity, data length and stop bits) specified in the communications program. It should be set up to transmit at 300, 1200, 2400, 4800, 9600, 14400 or 28800 bps (bits per second). Refer to the program's documentation and modem manual for information on how to change these settings.

The modem is on, set up properly and still won't transmit or receive data.

Make sure the line has a dial tone. Connect a telephone handset to the line to check this.

The other system you are trying to contact may be busy or disconnected.

The PC Card modem used to work, but doesn't anymore.

Check in Device Manager to see if the modem is listed.

If it is listed but has an X next to it, the modem is disabled. Double-click the device and then check the Undocked and Docked (if present) options before clicking OK.

If the modem is listed and has an exclamation point (!) next to it there may be a conflict with another device and that Windows 95 is unable to resolve the conflict. See the next section for suggestions on solving the conflict.

Develop Good Computing Habits

Sometimes we're in such a hurry to use a computer that we fail to adequately prepare for the inevitable problems that occur. This section suggests some good habits to develop so you are prepared should a problem occur.

Save your work often.

You can never predict when your computer will lock, forcing you to close a program and lose unsaved changes. Many software programs build in an automatic backup, but you shouldn't rely solely on this feature. Save your work!

On a regular basis, back up the information stored on your hard disk.

Here are a few ways you can do this:

- ❖ Copy files to disk in Windows 95, following the steps in "How to Copy Something to a Diskette" on page 95 or "How to Back Up Your Work" on page 96.
- ❖ Connect a tape drive to the system and use specialized software to copy everything on the hard disk to a tape.

Some people use a combination of these methods, backing up all files to tape weekly and copying critical files to disk on a daily basis.

If you've installed your own programs, you should back up your programs as well as your data files. If something goes wrong that requires you to format your hard disk and start over, reloading all your programs and data files from a backup will save time.

Read the manuals.

It's very difficult to provide a fail-safe set of steps you can follow every time you experience a problem with the computer. Your ability to solve problems will improve as you learn about how the computer and its software work together.

Get familiar with all the manuals provided with your computer, as well as the manuals that come with the programs and devices you purchase.

Your local computer store or book store sells a variety of self-help books you can use to supplement the information in the manuals.

If problem solving is taking a long time, take a break.

If you've been fighting to solve a problem for a long period of time, you're probably frustrated by now. Stand up and take a deep breath. Often, you can find a new solution to a problem just by stepping away from it for a few moments.

If You Need Further Assistance

If you have followed the recommendations in this chapter and are still having problems, you may need additional technical assistance. This section contains the steps to take to ask for help.

Before You Call

Since some problems may be related to the operating system or the program you're using, it's important to investigate other sources of assistance first. Try the following before contacting Toshiba:

- ❖ Review the troubleshooting information in your Windows 95 documentation.
- ❖ If the problem occurs while you are running a program, consult the program's documentation for troubleshooting suggestions. Contact the software company's technical support group for their assistance.

- ❖ Consult the dealer from whom you purchased your computer and/or program. Your dealer is your best source for current information.

For the number of a Toshiba dealer near you in the United States, call 1-800-457-7777.

Contacting Toshiba

If you still need help and suspect that the problem is hardware related, Toshiba offers a variety of resources to help you.

Start with the Automated Fax Service. Chances are you are not the only person to experience this problem. Toshiba has prepared useful information that can be faxed to you automatically. For instructions see “Toshiba's Automated Fax Service” on page 297.

Next, try one of Toshiba's on-line services. The Toshiba Forum is on CompuServe, and you can reach the Toshiba Bulletin Board Service (BBS) from any PC with a modem.

If you still can't find a solution to your problem, you can call Toshiba directly. See “Toshiba Voice Contact” on page 299 for details.

Toshiba's Automated Fax Service

Toshiba's Automated Fax Service System (AUTOFAX) provides ready access to useful information about Toshiba computers and accessories. You select documents using your touch-tone telephone. Toshiba's AUTOFAX System sends the requested information to your fax machine.

Follow these steps to access the system:

- 1 Dial the Toshiba InTouch Center at (800) 999-4273.**
- 2 Select option 1, then option 2. (You will be connected to the AUTOFAX system.)**
- 3 To have an index of available documents faxed to you, press 1.**

- 4 If you know the document number for the information you need, press 2.**
 - 5 To receive computer specifications, press 3.**
 - 6 Follow the automated instructions provided by the system.**
-



When entering the area code for your fax number, do not include the "1" prefix.

The AUTOFAX System automatically calls your fax number and sends the requested information. The process usually takes minutes, however, please allow up to 24 hours to receive the information due to varying load conditions.

If your fax machine telephone number is busy or otherwise unavailable, the system makes up to three attempts to complete a transaction.

Toshiba's Bulletin Board Service

Toshiba's Bulletin Board Service (BBS) is available 24-hours a day, and is free of charge to anyone with a PC and a modem. From Toshiba's BBS, you can download files and obtain other useful information to keep your computer running at peak performance.

Be sure you set your modem to Toshiba's BBS protocol:

Data Bits: 8
Parity: None
Stop Bits: 1

You may use the following telephone number:

714-837-4408

The Toshiba World Wide Web Sites

You can find Toshiba's World Wide Web site on the Internet at the following URL locations: <http://toshiba.computers.com> for product information and <http://pcsupport.tais.com> for product support.

The Toshiba Forum on CompuServe

Toshiba's Forum on CompuServe (CIS) gives you the opportunity to ask questions of system operators, to download information, and to access several Toshiba libraries that contain product information, user to user tips, and much more.

To access the Toshiba Forum:

- 1 Log on to Compuserve.**
- 2 From the CIS prompt type** go Toshiba.

Toshiba Voice Contact

To aid Toshiba, make sure you have:

- ❖ The computer and any optional devices related to the problem.
- ❖ The Microsoft Windows 95 diskettes, the Toshiba Companion Diskette, and the rest of the master diskettes. You created the Microsoft Windows 95 diskettes using Create System Disks and either made the other diskettes using Master Disk Creator or purchased Toshiba drivers and utilities directly from Toshiba.
- ❖ Toshiba drivers/utilities directly from Toshiba.
- ❖ Name and version of the program involved in the problem along with its installation diskettes.
- ❖ Information about what you were doing when the problem occurred.
- ❖ Exact error messages and when they occurred.

You can reach the Toshiba In-Touch Center at:

800-999-4273

Toshiba's Worldwide Offices

For additional help, contact one of these Toshiba offices:

Argentina

Smart, S.A.
Mexico (Street) 630,
Buenos Aires, 1097
Argentina

Austria

Toshiba Europe GmbH
Geschäftsbereich
Deutschland-Österreich
Hammfelddamm 8,
D-41460 Neuss
Austria

Brazil

Sistema Operacional
Rua Helena 170; 8 Andar,
V. Olimpia, CEP 04552-050
Sao Paulo, Brasil

Denmark

Scribona System AS,
Naverland 27,
DK2600 Glostrup
Denmark

France

Toshiba Systèmes France S.A.
7, Rue Ampère,
92804 Puteaux Cédex
France

Australia

Toshiba Australia Pty. Ltd.
Information Systems Division
84-92 Talavera Road North Ryde
N.S.W. 2113
Sydney
Australia

Belgium

Toshiba Information Systems
(Belgium)
S.A.N.V.
Rue Colonel Bourg Straat 123-125
B1140 Brussels
Belgium

Canada

Toshiba of Canada Ltd.
191 McNabb Street,
Markham, Ontario
L3R 8H2
Canada

Finland

Scribona System OY,
Sinimäentie 14,
02631 Espoo
Finland

Germany

Toshiba Europe GmbH
Geschäftsbereich
Deutschland-Österreich
Hammfelddamm 8,
D-41460 Neuss
Germany

Italy

CERO S.p.A
Via Saronnese, 16,
1-20025 Legnano (MI)
Italy

Mexico

Toshiba de Mexico
Paseo de la Reforma no. 30, 4-Piso,
Centro 06048 D.F.
Mexico City
Mexico

Norway

Scribona Norway AS,
Postboks 51, Kalbakken,
0901 Oslo 9
Norway

Spain

Toshiba Information Systems,
Parque Empresarial San Fernando
Edificio Europa, la planta,
Escalera A 28831 Madrid
Spain

Switzerland

Ozalid AG
Herostasse 7
8048 Zürich
Switzerland

Japan

Toshiba Corporation
International Operations-
Personal Computers
1-1, Shibaura 1-chome,
Minato-ku, Tokyo, 105-01
Japan

Netherlands

Toshiba Information Systems,
Benelux B.V.
Rivium Boulevard
41 2909 LK Capelle a/d Ussel
Netherlands

Portugal

DLI Distribucao,
Av. do Forte n.3-
Piso 4 (Ed. Suecia 11), P-
2795 Linda-a-Velha
Portugal

Sweden

Scribona System AB
Sundbybergsväegen 1,
17127 Solna,
Sweden

United Kingdom

Toshiba Information Systems
(U.K) LTD
Toshiba Court/Weybridge Business
Park
Addlestone Road
Weybridge, Surrey KT15 2UL
United Kingdom

302 **If Something Goes Wrong** *If You Need Further Assistance*

United States

Toshiba America Information
Systems, Inc.
9740 Irvine Boulevard
Irvine, California 92718
United States

For the most recent list of addresses, access Toshiba's AUTOFAX system (see page 297).

The Hotkeys

Hotkeys are keys that, pressed in combination with the Fn key, turn system functions on and off. Hotkeys have a dark blue legend on the front of the key indicating the option or feature the key controls.

Instant Password Security



This hotkey locks the keyboard and blanks the display. You must enter your password, if registered, or press Enter to begin work again.

Power

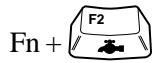

This hotkey displays the battery save pop-up window (in Windows 95 with MaxTime running) and switches among battery save modes: Full Power, Low Power, and User Settings.

Resume Mode



This hotkey displays the power-up pop-up window (in Windows 95 with MaxTime running) and turns Resume Mode on and off.

Sound



This hotkey cycles the alarm volume through Off, Low, Medium and High. Off is always first.

Display

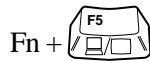

This hotkey alternates among the following display options: Built-in Display Only, Simultaneous Display and External Monitor Only.



When the computer is in Simultaneous mode, the external monitor will always be set to 800 by 600 SVGA mode. This is for compatibility with the internal LCD. Do not use Simultaneous mode with a monitor unable to support resolutions higher than 640 by 480.

Keyboard

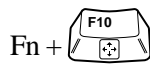

This hotkey turns the cursor control overlay on and off.

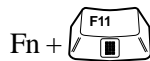

This hotkey turns the numeric overlay on and off.

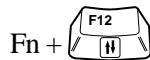

This hotkey turns the scroll lock feature on and off.

MaxTime

MaxTime opens automatically each time you start Windows 95. If MaxTime is not already open, follow these steps:

- 1 Click Start, then point to Programs.**
- 2 Point to Toshiba Utilities, then click MaxTime.**

Upon opening, MaxTime displays the MaxTime battery gauge.



The MaxTime battery gauge

The Display Dialog Box

To open the Display dialog box, choose Display from the MaxTime Options menu.

312 MaxTime

The Display Dialog Box

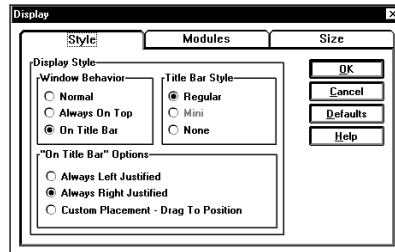

The Display dialog box

This dialog box controls the appearance of the MaxTime window. It provides four pages of display options, arranged like a stack of file folders. Each page of options has its own file folder tab.

To view or change these options, click the corresponding tab.

Buttons

The following table summarizes the buttons on the Display dialog box:

| <i>Button</i> | <i>Function</i> |
|---------------|--|
| OK | Saves current settings and exits the dialog box. |
| Cancel | Ignores current settings and exits the dialog box. |
| Defaults | Returns to the default settings. |
| Help | Accesses on-line help. |

The Style Page

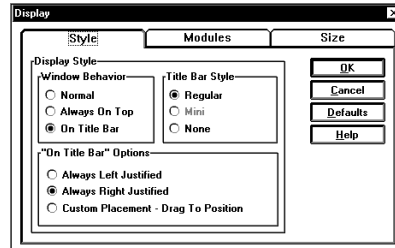

The Style page

The Style page controls the Display Style options: Window Behavior, Title Bar Style, and "On Title Bar" Options.

The Window Behavior option controls where the MaxTime window appears on your screen. The available settings are:

| <i>Settings</i> | <i>Description</i> |
|------------------|--|
| Normal (default) | Allows the MaxTime window to be covered by other active windows. |
| Always On Top | Keeps the MaxTime window on top of all other windows. |
| On Title Bar | Places the MaxTime window on the title bar of the currently active window. |

For more information about the Display Style option, refer to "Keeping the Battery Gauge Visible at All Times" on page 127.

The Title Bar Style option controls the size of the MaxTime window's title bar. The available settings are:

| <i>Settings</i> | <i>Description</i> |
|-------------------|--|
| Regular (default) | Displays the MaxTime title bar at full size. |
| Mini | Reduces the size of the MaxTime title bar. This setting is only available when you have the Display Style option set to Normal or Always On Top. |
| None | Hides the MaxTime title bar. This setting is only available when you have the Display Style option set to On Title Bar. |

The “On Title Bar” Options option controls where on the title bar the MaxTime window appears when you have the Window Behavior options set to On Title Bar. The available settings are:

| <i>Settings</i> | <i>Description</i> |
|------------------------------------|---|
| Always Left Justified | Always places the MaxTime window at the left side of the title bar of the currently active window. |
| Always Right Justified | Always places the MaxTime window at the right side of the title bar of the currently active window. |
| Custom Placement- Drag to Position | Allows you to choose the placement of the MaxTime window on the title bar of the currently active window. |

The Modules Page

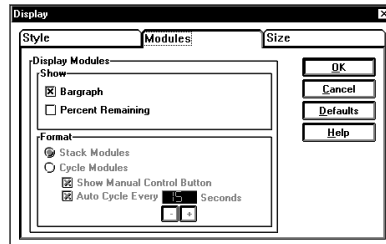

The Modules page

The Modules page controls the Display Modules options: Show and Stack.

The Show option lets you choose which modules are displayed in the MaxTime window. The available modules are:

| <i>Module</i> | <i>Description</i> |
|---------------------|--|
| Bar graph (default) | Displays the current battery charge as a horizontal bar graph. |
| Percent Remaining | Displays the current battery charge as a percentage. |

For more information about choosing the MaxTime modules, refer to “Changing the Appearance of the Battery Gauge” on page 125.

316 MaxTime

The Display Dialog Box

If you choose more than one module for the Show option, the Stack option is activated. The available settings are:

| <i>Settings</i> | <i>Description</i> |
|-----------------|--------------------------------------|
| Stack Modules | Shows all selected modules at once. |
| Cycle Modules | Cycles between the selected modules. |

If you set the Show option to Cycle Modules, you can choose one or both of the following settings:

| <i>Settings</i> | <i>Description</i> |
|------------------------------------|--|
| Show Manual Control Button | Includes a manual control button in the MaxTime window. You can click this button to switch to the next selected module. |
| Auto Cycle Every <i>xx</i> Seconds | Switches to the next selected module every <i>xx</i> seconds, where <i>xx</i> is a number you set by clicking the + and - buttons. |

The Size Page

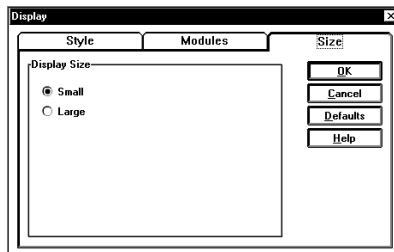

The Size page

The Size page controls the size of the modules in the MaxTime window. The available settings are: Small and Large.

The Alarms Dialog Box

To open the Alarms dialog box, choose Alarms from the Max-Time Options menu.

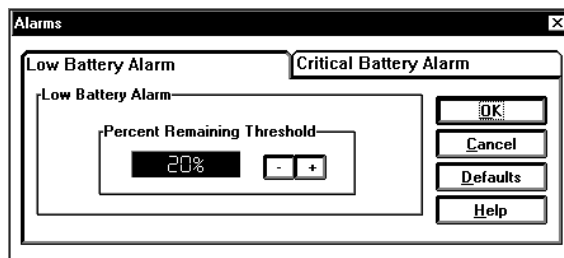

The Alarms dialog box

This dialog box displays the options for the Low Battery Alarm and the Critical Battery Alarm on two separate pages, arranged like a stack of file folders. Each page of options has its own file folder tab. The options for these alarms are identical.

To view or change these options, click the corresponding tab.

Buttons

The following table summarizes the buttons on the Alarms dialog box:

| <i>Button</i> | <i>Function</i> |
|---------------|--|
| OK | Saves current settings and exits the dialog box. |
| Cancel | Ignores current settings and exits the dialog box. |
| Defaults | Returns to the default settings. |
| Help | Accesses on-line help. |

Alarm Options

The following table summarizes the options you can set in the Alarms dialog box:

Option: Percent Remaining Threshold

Settings: xx% (where xx is a percentage you set)

Usage: Allows you to set the trigger point for the battery alarm.

Option: Trigger Alarm

Settings: Based on Percent Remaining Threshold

Usage: Enables the battery alarm.

For more information about setting the battery alarms, refer to “Setting the Alarms” on page 132.

The Set Battery Charge Dialog Box

The computer estimates the current battery charge automatically. If for some reason it doesn't know the battery charge, you can set it manually in the Set Battery Charge dialog box.

To open the Set Battery Charge dialog box, choose Set Battery Charge from the MaxTime Options menu. You may only choose this option when the battery charge is unknown to the system.

You may never need to set the battery charge unless the battery or the system is faulty.

Buttons

The following table summarizes the buttons on the Set Battery Charge dialog box:

| <i>Button</i> | <i>Function</i> |
|---------------|--|
| OK | Saves current settings and exits the dialog box. |

| <i>Button</i> | <i>Function</i> |
|---------------|--|
| Cancel | Cancels current settings and exits the dialog box. |
| Help | Accesses on-line help. |

Battery Charge Options

The following table summarizes the battery charge options:

Option: Battery Charge

Settings: xx% (where xx is a percentage you set)

Usage: Allows you to estimate the percentage of battery charge remaining.

Option: Disable automatic battery charge inquiry

Settings: Enabled (check) *or* Disabled (no check)

Usage: Enables and disables the system's automatic battery charge inquiry.

For more information on setting an unknown battery charge, see “What to Do When Your Computer Doesn’t Know the Battery Charge” on page 129.

The Machine Settings Dialog Box

To open the Machine Settings dialog box, choose Machine Settings from the MaxTime Options menu.

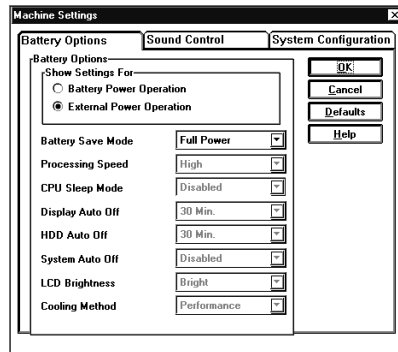

The Machine Settings dialog box

This dialog box controls the battery, sound control, and system configuration options. It provides three pages of options, arranged like a stack of file folders. Each page of options has its own file folder tab.



If a supervisor-level password is registered, you must enter it before you can use the Machine Settings dialog box. See "Working with Supervisor-Level Passwords" on page 237 for more information about supervisor-level passwords.

To view or change these options, click the corresponding tab.

The Battery Options Page

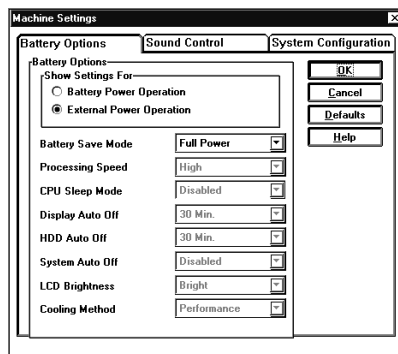

The Battery Options page

This page controls the battery options. The available options are:

Option: Show Settings For

Settings: Battery Power Operation *or* External Power Operation

Usage: Shows settings for use with battery power operation or external power operation.

Option: Battery Save Mode

Settings: Full Power *or* Low Power *or* User Settings

Usage: Allows you to select a preset battery save mode or customize the battery save options. For more information, see “Conserving Power” on page 138.

Option: Processing Speed

Settings: High (default) *or* Low

Usage: Sets the speed at which the Central Processing Unit (CPU) processes information. For more information, see “Processing Speed” on page 141.

Option: CPU Sleep Mode

Settings: Enabled (Low Power default) *or* Disabled (Full Power default)

Usage: If enabled, temporarily shuts down the processor when there are no processing requests, such as keyboard input or pointing device movement. For more information, see “CPU Sleep Mode” on page 141.

Option: Display Auto Off

Settings: Time periods of 1, 3 (Low Power default), 5, 10, 15, 20 and 30 minutes *or* Disabled (Full Power default)

Usage: Turns the display off if it is not used for the time selected. For more information, see “Display Auto Off” on page 141.

Option: HDD Auto Off

Settings: Time periods of 1, 3 (Low Power default), 5, 10, 15, and 20 minutes *or* a 30-minute period (Full Power default).

Usage: Turns the hard disk drive off if it is not used for the time selected. For more information, see “HDD Auto Off” on page 141.

Option: System Auto Off

Settings: Time periods of 10, 20, 30, 40, 50, and 60 minutes *or* Disabled (default)

Usage: Turns the system off if you haven't used the computer for the time selected. For more information, see “System Auto Off” on page 142.

Option: LCD Brightness

Settings: Bright (Full Power default) *or* Semi-Bright (Low Power default)

Usage: Sets the brightness of the display. For more information, see “LCD Brightness” on page 142.

Option: Cooling Method

Settings: Performance (Full Power default) or Quiet (Low Power default)

Usage: Determines the method used to cool the computer's processor chip. For more information see "Cooling Method" on page 142.

The Sound Control Page

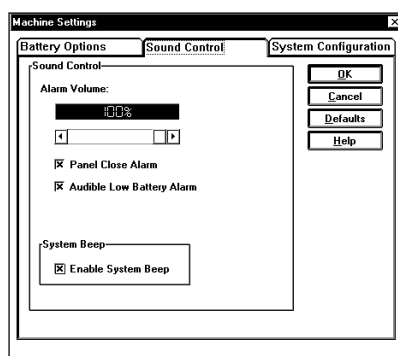

The Sound Control page

This page sets the sound control options. The available options are:

Option: Alarm Volume

Settings: 0%, 33%, 66% and 100%

Usage: Sets the volume at which the speaker plays sounds.

Option: Panel Close Alarm

Settings: Enabled (check) or Disabled (no check)

Usage: Enables and disables the alarm that sounds when you close the display panel while the computer is on. For more information, see "How and When to Turn the Computer Off" on page 107.

Option: Audible Low Battery Alarm

Settings: Enabled (check) or Disabled (no check)

Usage: Enables and disables the system's built-in audible battery alarm.

Option: Enable System Beep

Settings: Enabled (check) or Disabled (no check)

Usage: Enables and disables the system beeps.

The System Configuration Page

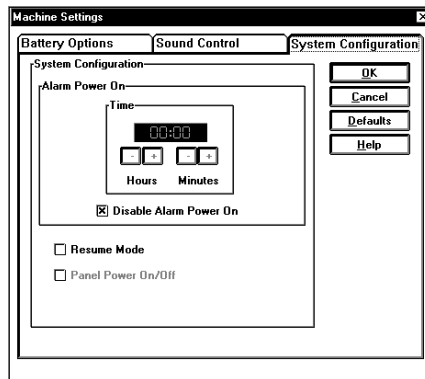

The System Configuration page

This page controls the system configuration options. The available options are:

Option: Alarm Power On

Settings: hour:minute

Usage: Sets the system to turn on at the time selected (24-hour format).
For more information, see “Different Ways to Turn the Computer On and Off” on page 255.

Option: Disable Alarm Power On

Settings: Enabled (check) or Disabled (no check)

Usage: When enabled, turns off the Alarm Power On feature.

Option: Resume Mode

Settings: Resume Mode (check) *or* Boot Mode (no check)

Usage: Turns Resume Mode on and off. For more information, see “Starting Again Where You Left Off” on page 133.

Option: Panel Power On/Off

Settings: Enabled (check) *or* Disabled (no check)

Usage: Turns the computer on/off when you open/close the computer's display panel. This option is only available when Resume Mode is selected. For more information, see “Different Ways to Turn the Computer On and Off” on page 255.

Hardware Setup

To open Hardware Setup, follow these steps:

- 1 Click Start, then point to Programs.
- 2 Point to Toshiba Utilities, then click Hardware Setup.

Hardware Setup displays the following dialog box:

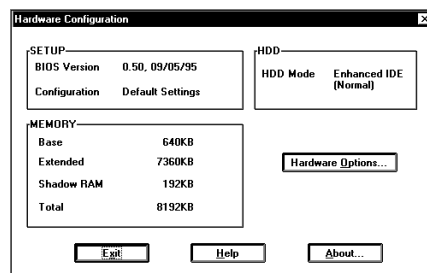

The Hardware Configuration dialog box

The Hardware Configuration Dialog Box

This dialog box displays system information. The values are calculated by the system and cannot be changed. It is for reference only.



If a supervisor-level password is registered, you must enter it before you can use Hardware Setup. See "Working with Supervisor-Level Passwords" on page 237 for more information about supervisor-level passwords.

Buttons

The following table summarizes the buttons on the Hardware Configuration dialog box:

| <i>Button</i> | <i>Function</i> |
|------------------|--|
| Exit | Exits the dialog box. |
| Help | Accesses online help. |
| About | Displays information about the Hardware Setup program. |
| Hardware Options | Opens the Hardware Configuration Options dialog box. |

The SETUP section

This section of the Hardware Configuration dialog box displays general information about the system:

| <i>Information</i> | <i>Discussion</i> |
|--------------------|--|
| BIOS Version | Indicates the version and date of the computer's Basic Input/Output System (BIOS). |
| Configuration | Indicates whether you're using the default configuration settings (Default Settings), or have changed any of the configuration settings (Custom Settings). |

The MEMORY section

This section shows how the computer's memory is allocated. These values are calculated automatically by the system and cannot be changed.

| <i>Memory Type</i> | <i>Description</i> |
|--------------------|---|
| Base | Displays the amount of conventional memory available to the computer. |
| Extended | Displays the amount of extended memory available. |
| Shadow RAM | Displays the amount of memory available for Shadow RAM. Shadow RAM copies (shadows) the computer's BIOS functions from ROM into faster RAM to improve system speed. |
| Total | Displays the total amount of memory installed. |

The HDD section

This section shows that the hard disk is set to Enhanced IDE mode. This is for your information only and cannot be changed.

The Hardware Configuration Options Dialog Box

To open this dialog box, choose Hardware Options in the Hardware Configuration dialog box.

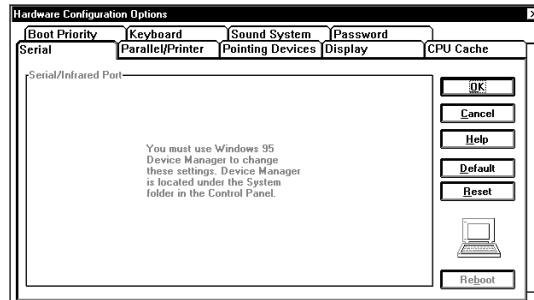

The Hardware Configuration Options dialog box

This dialog box controls the hardware configuration options. It provides nine pages of options, arranged like a stack of file folders. Each page of options has its own file folder tab.

To view or change these options, click the corresponding tab.

Restart Indicators

When you change an option that does not require the system to restart, Hardware Setup displays a small gray triangle to the left of the tab caption.

When you change an option that requires the system to restart, Hardware Setup displays a small lightning bolt icon to the right of the tab caption and in the computer screen at the lower right corner of the dialog box.

The Legend Field

Each page of hardware configuration options has a Legend field. This field displays information to help you choose option settings. For example, when you choose the Keyboard page, the Legend field displays the following message: “The keyboard options facilitate the configuration of both the internal and external (if one is attached) keyboards.”

Buttons

The following table summarizes the buttons on the Hardware Configuration Options dialog box:

| <i>Button</i> | <i>Function</i> |
|---------------|---|
| OK | Accepts your changes and exits the dialog box. |
| Cancel | Ignores the changes you made and exits the dialog box. |
| Help | Accesses online help. |
| Default | Returns all options to their default settings. To make the defaults permanent, you must click OK. |
| Reset | Returns all options to the settings in effect when you opened the dialog box. |
| Reboot | Immediately restarts the computer. This button is available only if you change an option that requires a restart. |

The Serial Page

The options on this page are grayed out and cannot be changed. Use the Ports icon in Windows 95 Device Manager to change the Serial Port setting. Refer to “Using Device Manager to Configure Your System” on page 253 for instructions.

The Parallel/Printer Page

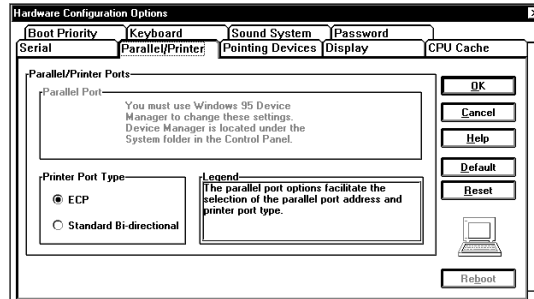

The Parallel/Printer page

The Parallel/Printer page controls the computer's parallel port:

Option: Printer Port Type

Settings: ECP (default) or Standard Bi-directional

Usage: Configures the parallel port to be used with a printer or other parallel device. Refer to the device's documentation to determine the setting it requires.

Restart: Y



The Parallel Port option is grayed out and cannot be changed. Use the Ports icon in Windows 95 Device Manager to change this setting. Refer to "Using Device Manager to Configure Your System" on page 253 for instructions.

The Pointing Devices Page

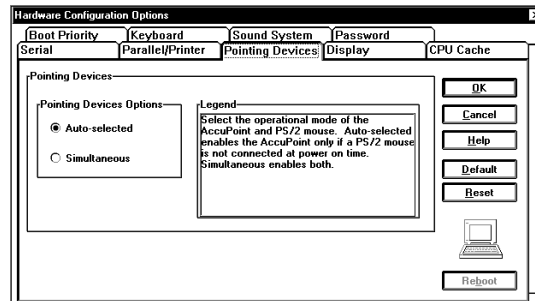

The Pointing Devices page

The Pointing Devices page controls the pointing devices option.

Option: Pointing Devices

Settings: Auto-selected (default) or
Simultaneous (This option does not affect serial pointing devices.)

Usage: Lets you use the AccuPoint, an optional PS/2 pointing device connected to the NoteDock, or both.

Restart: Y

The Display Page

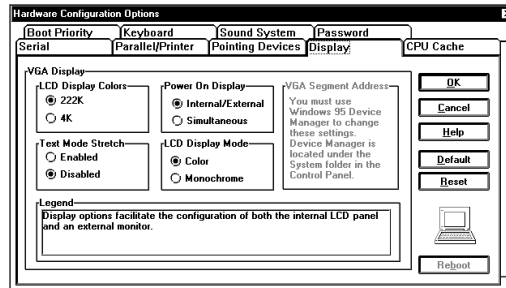

Sample Display page

The Display page controls the display options. The available settings are:

Option: LCD Display Colors

Settings: 222K Colors or 4096 Colors (default)

Usage: Controls the number of colors available to the display.

Restart: Y

Option: Power On Display

Settings: Internal/External (default) or Simultaneous

Usage: Controls whether the system sends output to the internal display, the external display, or both when you turn the computer on.

Restart: Y

Option: LCD Display Mode

Settings: Color (default) or Monochrome

Usage: Controls whether the computer displays images in color or in black and white.

Restart: Y

Option: Text Mode Stretch

Settings: Enabled or Disabled (default)

Usage: Slightly modifies the spacing in MS-DOS programs so that the program uses the entire screen. With this option disabled, there is a small blank space at the top and bottom of the screen.



The VGA Segment Address option is grayed out and cannot be changed. Use the Display adapters icon in Windows 95 Device Manager to change this setting. Refer to "Using Device Manager to Configure Your System" on page 253 for instructions.

The CPU Cache Page

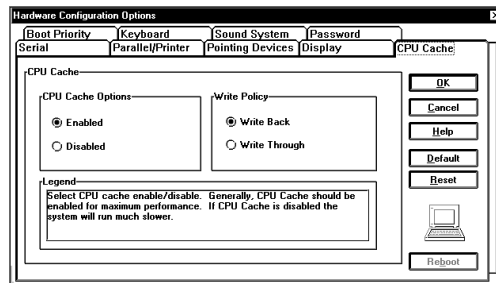

The CPU Cache page

The CPU Cache page controls the CPU Cache option.

Option: CPU Cache

Settings: Enable (default) or Disable

Usage: Improves system performance when enabled.
Disable this option only if your software requires you to do so.

Restart: Y

The Boot Priority Page

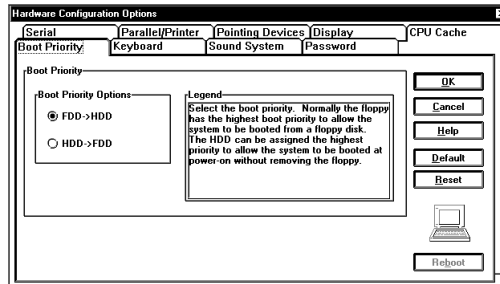

The Boot Priority page

This page controls the Boot Priority option.

Option: Boot Priority

Settings: FDD→HDD (default) or HDD→FDD

Usage: Determines whether the system looks for the operating system first on the hard disk (HDD) or the diskette drive (FDD) when you turn the computer on.

Restart: N

The Keyboard Page

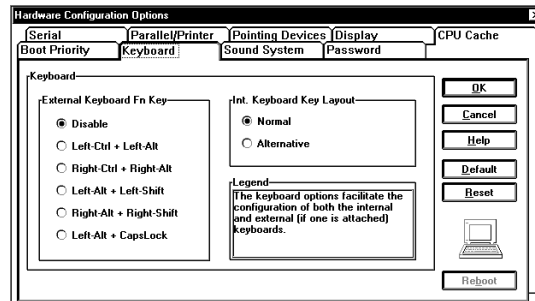

The Keyboard page

This page controls the keyboard options.

Option: External Keyboard Fn Key

Settings: Disable (default)

Settings: Left-Ctrl + Left-Alt

Settings: Right-Ctrl + Right-Alt

Settings: Left-Alt + Left-Shift

Settings: Right-Alt + Right-Shift

Settings: Left-Alt + CapsLock

Usage: Allows you to use the selected key combination to emulate the computer's Fn key on an external keyboard. For more information, see “Making Your External Keyboard Pretend it Has the Fn Key” on page 216.

Restart: N

Option: Int. Keyboard Key Layout

Settings: Normal (default) or Alternative

Usage: Selects the layout of the keyboard's Caps Lock, Ctrl, and Alt keys. For more information, see “Selecting the Keyboard Layout” on page 251.

Restart: Y

The Sound System Page

The options on this page are grayed out and cannot be changed. Use the Sound, video and game controllers icon in Windows 95 Device Manager to change the sound system I/O Address and DMA Channel settings. Refer to “Using Device Manager to Configure Your System” on page 253 for instructions.

The Password Page

Refer to “Using a Password” on page 229 for information about your notebook’s security options.

TSETUP



Run TSETUP outside of Windows 95, at a system prompt. If you try to run TSETUP from an MS-DOS session under Windows 95, results can be unpredictable.

- 1 If you're currently in Windows 95, click Start, then click Shut Down.**
- 2 Click the button next to Restart the computer in MS-DOS mode and click Yes.**

Windows 95 shuts down the computer, then restarts it in MS-DOS mode and displays a system prompt.

- 3 Type:** `c:\dos\tsetup`

TSETUP displays a screen.

342 TSETUP

Making Changes in TSETUP

| MEMORY | | SYSTEM SETUP | | I/O PORTS | |
|-----------------|----------|---------------|--------------------|-----------|--|
| Total | = 8192KB | Serial Port | = COM1 (IRQ4/3F8H) | | |
| Base | = 640KB | Infrared Port | = Not Used | | |
| Extended | = 7360KB | Parallel Port | = LPT1 (378H) | | |
| Shadow BIOS ROM | = 192KB | Sound System | = Address/IRQ/DMA | | |

| DISPLAY | | OTHERS | |
|---------------------|---------------------|--------------------|--------------|
| Display Adaptor | = VGA Compatible | Power-up Mode | = Boot |
| LCD Display Mode | = Color | CPU Cache | = Enabled |
| VGA Segment Address | = E000H | Battery Save Mode | = Full Power |
| LCD Display Colors | = 256K Colors | Alarm Volume | = High |
| Power On Display | = Internal/External | System Beep | = Enabled |
| Text Mode Stretch | = Enabled | Panel Power On/Off | = Disabled |

| HARD DISK | |
|-----------|-------------------------|
| HDD Mode | = Enhanced IDE (Normal) |

| PASSWORD | |
|----------------|--|
| Not Registered | |

↑←→:Select items Space, BkSp:Change Values
Esc:Exit without saving Home:Set default values End:Save changes and Exit

A sample System Setup screen

Making Changes in TSETUP

This table lists the keys to use in TSETUP.

| <i>Key(s)</i> | <i>Result</i> |
|-------------------|--|
| ← and → | Moves between the two columns. |
| ↑ and ↓ | Moves between items in a column. |
| Spacebar and BkSp | Changes the selected item. |
| Esc | Quits TSETUP without saving changes. |
| End | Saves your changes and quits TSETUP, restarting the computer if necessary. |
| Home | Resets each option to its factory preset value. |



If a supervisor-level password is registered, you must enter it before you can use TSETUP. See "Working with Supervisor-Level Passwords" on page 237 for more information about supervisor-level passwords.

Closing TSETUP

To close TSETUP and keep your changes, press End. When TSETUP asks you to confirm your action, press Y. TSETUP closes with your changes in effect and restarts the computer or returns you to the system prompt, depending on the changes you made.

To close TSETUP without saving your changes, press Esc. When TSETUP asks you to confirm your action, press N. TSETUP returns you to the system prompt.

MEMORY

This group shows how the computer's memory is allocated.

| <i>Memory Type</i> | <i>Description</i> |
|--------------------|---|
| Total | Displays the total amount of memory installed. |
| Base | Displays the amount of conventional memory available to the computer. |
| Extended | Displays the amount of extended memory available. |
| Shadow BIOS ROM | Displays the amount of memory available for Shadow BIOS ROM. Shadow BIOS ROM copies (shadows) the computer's BIOS functions from ROM into faster RAM to improve system speed. |

These values are calculated by the system and cannot be changed.

DISPLAY

This group configures the Liquid Crystal Display (LCD) and monitor port output.

Option: Display Adaptor

Settings: VGA Compatible (default)

Usage: Automatically turns on the computer's internal display adapter. You cannot change this setting.

Restart: N/A

Option: LCD Display Mode

Settings: Color (default) or Monochrome

Usage: Controls whether the computer displays images in color or in black and white.

Restart: Y

Option: VGA Segment Address

Settings: E000h (default) or C000h or E4000h

Usage: Lets you set the memory location for video BIOS. The default of E000 - EFFF uses 64KB of UMB (upper memory block) memory. The other options use only 48KB of UMB memory.

Restart: Y

Option: LCD Display Colors (CDS Models)

Settings: 222K Colors (default) or 4096 Colors

Usage: Controls the number of colors available to the display.

Restart: Y

Option: Power On Display

Settings: Internal/External (default) or Simultaneous

Usage: Controls whether the system sends output to the internal display, the external display, or both when you turn the computer on in boot mode.

Restart: Y

Option: Text Mode Stretch

Settings: Enable or Disable (default)

Usage: The screen has a height of 600 pixels. In a text mode, which uses 400 pixels, this leaves a small amount of space above and below the text on the screen. Enabling this mode stretches the text to fill the entire screen.

Restart: N



Changes you make to the VGA Segment Address setting in TSETUP will not affect Windows 95. To set this option for Windows 95, use the Display adapters icon in Windows 95 Device Manager. Refer to "Using Device Manager to Configure Your System" on page 253.

HARD DISK

This section shows that the hard disk is set to Enhanced IDE mode.

Option: HDD Mode

Settings: Enhanced (default) or Standard IDE

Usage: Use Enhanced for MS-DOS or Windows 95. Use Standard for Novell Netware, or Unix environments that do not recognize hard disks larger than 540MB.

Restart: Y

PASSWORD

This group lets you set or reset the user-level system password. For more information about the computer's password features, see "Using a Password" on page 229.

Settings: Registered *or* Not Registered (default)

Restart: N

If you set a new password, TSETUP offers you the chance to create a password service diskette. This diskette lets you start the computer even if you forget your password. For complete information about creating and using a password service diskette, see "Password Retrieval" on page 232.

I/O PORTS

This group allows you to configure communications port settings for the serial and parallel ports.



Changes you make to these settings in TSETUP will not affect Windows 95. To set these options for Windows 95, use the Ports icon in Windows 95 Device Manager. Refer to "Using Device Manager to Configure Your System" on page 253.

Option: Serial Port

Settings: The default setting — COM1 (IRQ4/3F8H); *or* COM2 (IRQ3/2F8H); COM3 (IRQ4/3E8H); COM4 (IRQ3/2E8H); *or* Not Used

Usage: Sets the serial port name through which your communications software sends output to the serial port.

Restart: Y

Option: Infrared Port

Settings: COM1 (IRQ4/3F8H); COM2 (IRQ3/2F8H); COM3 (IRQ4/3E8H); COM4 (IRQ3/2E8H); or Not Used (default)

Usage: Sets the IrDA port name that your transfer program uses to send and receive information.

Restart: Y

Option: Parallel Port

Settings: LPT1 (378H) (default); LPT2 (278H); LPT3 (3BCH); or Not Used

Usage: Sets the parallel port name through which the computer communicates with the parallel port.

Restart: Y

If you set the Parallel Port to anything other than Not Used, a drop-down list box appears offering a choice between ECP (default) and Standard Bidirectional. Use ECP for ECP-compatible devices. If your device operates incorrectly while this option is set to ECP, try changing the option to Bidirectional. A DMA channel option is also available. Its settings are 1, 2, and 3 (default).

Option: Sound System

Settings: Address/IRQ/DMA or Disabled

Usage: lets you choose a unique I/O address, an Interrupt Request (IRQ) number, and a Direct Memory Address (DMA) channel for the sound system or to disable it.

Restart: Y

The following sound system options are in a drop-down list box that appears when you highlight Address/IRQ/DMA for the Sound System option:

Option: I/O Address

Settings: 220H (default); 230H; 240H; or 250H

Usage: Lets you assign a unique Input/Output (I/O) address to the sound system.

Restart: Y

Option: Interrupt Level

Settings: IRQ5, IRQ7, IRQ9, or IRQ10 (default)

Usage: Allows you to assign a unique interrupt level to the sound system.

Restart: Y

Option: DMA Channel

Settings: Channel 0, Channel 1 (default), or Channel 3

Usage: Lets you assign a unique Direct Memory Address (DMA) channel to the sound system.

Restart: Y

OTHERS

This group allows you to set many other configuration options. Whether or not you need to use these options depends primarily on the software and devices you use.

Option: Power-up Mode

Settings: Resume *or* Boot (default)

Usage: Alternates between Resume Mode and Boot Mode.

Restart: N

Option: CPU Cache

Settings: Enabled (default) *or* Disabled

Usage: Improves system performance. Disable this option only if your software or optional devices require you to do so.

If you set the CPU Cache to Enabled, a drop-down box lets you choose between Write-back (default) and Write-through. Write-back provides maximum performance. Write-through reduces performance to offer compatibility with older programs that may not run on a fast system.

Restart: Y

Option: Battery Save Mode

Settings: Full Power (default), Low Power and User Settings

Usage: Allows you to select a preset battery save mode or customize the battery save options. For more information about choosing a battery save mode, see “The Easy Way—Choosing a Battery Save Mode” on page 138.

Restart: N

Option: Alarm Volume

Settings: Off, Low, Medium, and High (default)

Usage: Sets the volume at which the system's alarms beep (such as the low battery alarm). This also affects sounds generated by any PC card modem installed.

Restart: N

Option: System Beep

Settings: Enabled (default) *or* Disabled

Usage: Enables and disables your software's use of the system speaker.

Restart: N

Option: Panel Power On/Off

Settings: Enabled *or* Disabled (default)

Usage: Turns the computer on/off when you open/close the computer's display panel. This option is only available when Resume Mode is selected. For more information, see "Different Ways to Turn the Computer On and Off" on page 255.

Restart: N

Option: Alarm Power On

Settings: xx:xx:xx (hour:minute: second) *or* Disabled (default)

Usage: Turns the computer on at the time set. For more information, see "Different Ways to Turn the Computer On and Off" on page 255.

Restart: N

Option: Int. Keyboard Key Layout

Settings: Normal (default) *or* Alternative

Usage: Selects the layout of the keyboard's Caps Lock, Ctrl, and Alt keys. For more information, see "Selecting the Keyboard Layout" on page 251.

Restart: Y

Option: External Keyboard "Fn" Key Equivalent

Settings: Disabled (default) *or* left Ctrl + left Alt; right Ctrl + right Alt; left Alt + left Shift; right Alt + right Shift; left Alt + CapsLock

Usage: Allows you to use the selected key combination to emulate the computer's Fn key on an external keyboard. For more information, see "Making Your External Keyboard Pretend it Has the Fn Key" on page 216.

Restart: N

Option: Pointing Devices

Settings: Auto-selected (default) *or* Simultaneous (This option does not affect serial pointing devices.)

Usage: Sets which pointing device is active when you connect an external PS/2 pointing device to the computer.

Restart: Y

Option: Boot Priority

Settings: FDD→HDD (default) *or* HDD→FDD

Usage: Determines whether the system looks for the operating system first on the hard disk (HDD) or the diskette drive (FDD) when you turn the computer on.

Restart: N

The following battery save options appear in a drop-down list box when you highlight Battery Save Mode. You can only change the settings in this box if the Battery Save Mode is set to User Settings:

Option: Processing Speed

Settings: High (default) *or* Low

Usage: Sets the speed at which the Central Processing Unit (CPU) processes information. High runs at 100 MHz. Low adds pauses, effectively reducing processing speed to approximately 50 MHz.

Restart: N

Option: CPU Sleep Mode

Settings: Enabled (Full Power default) *or* Disabled (Low Power default)

Usage: If enabled, temporarily shuts down the processor when there are no processing requests, such as keyboard input or pointing device movement. For more information, see “CPU Sleep Mode” on page 141.

Restart: N

Option: Display Auto Off

Settings: Time periods of 1, 3 (Low Power default), 5, 10, 15, 20, and 30 minutes (Full Power default on CT) *or* Disabled (Full Power default on CS)

Usage: Turns the display off if it is not used for the time set. For more information, see “Display Auto Off” on page 141.

Restart: N

Option: HDD Auto Off

Settings: Time periods of 1, 3 (Low Power default), 5, 10, 15, 20, and 30 minutes (Full Power default)

Usage: Turns the hard disk drive off if it is not used for the time set.

Restart: N

Option: System Auto Off

Settings: Time periods of 10, 20, 30 (Low Power default), 40, 50 and 60 minutes *or* Disabled (Full Power default)

Usage: Turns the system off if you haven't used the computer for the time set. This option is available only if Resume Mode is on. For more information, see "System Auto Off" on page 142.

Restart: N

Option: LCD Brightness

Settings: Bright (Full Power default) *or* Semi-Bright (Low Power default)

Usage: Sets the brightness of the display. For more information, see "LCD Brightness" on page 142.

Restart: N

Option: Cooling Method

Settings: Performance (Full Power default) *or* Quiet (Low Power default)

Usage: Sets the cooling method. For more information, see "Cooling Method" on page 142.

Restart: N

The following sound options are in a drop-down list box that appears when you select Low, Medium or High for Alarm Volume:

Option: Low Battery Alarm

Settings: Enabled (default) *or* Disabled

Usage: Enables and disables the system's built-in audible battery alarm.

Restart: N

Option: Panel Close Alarm

Settings: Enabled (default) *or* Disabled

Usage: Enables and disables the alarm that sounds when you close the display panel while the computer is on. For more information, see “How and When to Turn the Computer Off” on page 107.

Restart: N

The Diagnostic Test

This chapter explains how to use the diagnostic test program TDIAGS.EXE to determine if your system components are working properly.

Use the diagnostic test if you have a problem you could not identify with the tips listed in the chapter “If Something Goes Wrong” on page 269. The test verifies that the following system components (hardware) are in working order:

- ❖ system (the computer's internal hardware)
- ❖ memory
- ❖ video
- ❖ diskette drive
- ❖ hard disk drive
- ❖ printer (if you have one attached)

This chapter explains each of these tests in detail.

Starting the Diagnostic Test

To test hardware, it's important to start the diagnostic test without optional features or programs (for example, without memory-resident programs). To do so, you should run TDIAGS from the Toshiba Companion Diskette using the Toshiba Companion Utility (even though the TDIAGS program is on the hard disk).

Before you start the test, check all cables for loose connections. If any errors occur during the test, check all cable connections again.

To start the test, follow these steps:

1 Click Start, then click Shut Down.

Windows 95 displays the Shut Down Windows dialog box.

2 Click the button next to Restart the computer in MS-DOS mode and click Yes.

Windows 95 shuts down, then restarts in MS-DOS mode and displays a system prompt.

3 If your diskette drive is not installed in the SelectBay, connect the external diskette drive or swap drives in the SelectBay. To swap drives, see “Swapping Drives in the SelectBay” on page 104.

4 Put the Toshiba Companion Diskette in drive A and press Ctrl + Alt + Del.

After a moment, the computer displays a Welcome screen.

5 Press Enter.

The Toshiba Companion Utility displays its main menu:

Main Menu

Install Utilities and Files
View README Documents
Setup Your Computer
Run Diagnostics
Set Passwords
Exit to DOS

- 6 Use the arrow keys to select **Run Diagnostics** and press Enter.

TDIAGS asks you to confirm that you want to run the diagnostic test.

- 7 To run the diagnostic test, press **Y (for yes)**, and press Enter.

The following sections explain the diagnostic test options.

Choosing Test Options

Before the test begins, the program asks several questions about which components you wish to test.

- 1 The first question asks if you want to test the diskette drive(s). The computer displays:

Test the FDD (Y/N)?

- 2 To test the diskette drive(s), type **Y** and press Enter. To bypass the test, type **N** and press Enter.

The FDD (floppy disk drive) test tests the diskette drive. Make sure you attach the external diskette drive or install it in the SelectBay before running this test.



The test writes test patterns on any disk in the drive. These patterns destroy all information on the disk(s). Make sure there is no information you want to keep on the disk(s) you use.

If you choose the FDD test, you must format and write-enable the disk before the test. Move the write-protect tab to cover the square hole.

The next prompt asks if you want to test the hard disk drive:

Test the HDD (Y/N)?

- 3 To test the hard disk, type Y and press Enter. Otherwise, type N and press Enter.**
-



The hard disk test overwrites a portion of the information stored on the disk. Back up any important files before you test the hard disk.

The following prompt appears:

Test the printer (Y/N)?

- 4 Type Y to test the printer, or N to skip the test, and press Enter.**

Before beginning the test, make sure the printer is connected to the computer, the power is turned on, and the printer is on line.

If you chose to test the printer, the prompt displays:

Compatible with IBM printer (Y/N)?

- 5 To test an IBM or an IBM-compatible printer, type Y and press Enter. To test a non-IBM-compatible printer, type N and press Enter.**

If you choose an IBM printer when your printer is not an IBM or IBM-compatible printer, the test output will be unintelligible and may cause the printer to eject multiple blank pages. If you're not sure about your printer's compatibility, type N for a non-IBM-compatible printer.

Test Sequence

The diagnostic test checks the computer's components and printer in a predefined sequence as follows:

- ❖ system test
- ❖ memory test
- ❖ display test
- ❖ FDD (floppy disk drive or diskette drive) test

- ❖ HDD (hard disk drive) test
- ❖ printer test

While a test is in progress, the program displays:

IN PROGRESS *TSSDSS*

where *T* indicates the test number, the first *SS* indicates the subtest number, *D* indicates the drive (if tested), and the second *SS* indicates the hardware status. This message may remain on the screen for a moment. The following sections describe each subtest.

System Functions and Memory

The system functions and the memory tests run together for approximately five seconds. The system functions test doesn't display any messages. The memory test displays the following message:

PROGRESS *xxxxxx*

where *xxxxxx* is the current memory location being tested. The memory test includes conventional and extended memory.

If either test aborts:

- 1 Write down everything that appears on the screen.**
- 2 Press Ctrl + Pause to return to the diagnostics menu.**
- 3 Consult your dealer.**

Character Attributes

When the memory test completes, the diagnostic test displays the following screen:

```
CHARACTER ATTRIBUTES
NEXT LINE SHOWS NORMAL DISPLAY.
NNNNNNNNNNNNNNNNNNNNNNNNNNNNNNNN
NEXT LINE SHOWS INTENSIFIED DISPLAY.
IIIIIIIIIIIIIIIIIIIIIIIIIIIIIIII
NEXT LINE SHOWS REVERSE DISPLAY.
RRRRRRRRRRRRRRRRRRRRRRRRRRRRRRR
NEXT LINE SHOWS BLINKING DISPLAY.
BBBBBBBBBBBBBBBBBBBBBBBBBBBBBBB

```

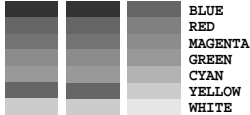

```
BLUE
RED
MAGENTA
GREEN
CYAN
YELLOW
WHITE
```

Press [Enter] key

Character attributes test screen

Look under the message NEXT LINE SHOWS BLINKING DISPLAY to make sure the line is actually blinking.

If your screen doesn't match the diagnostic test display, write down the differences and contact your dealer. If your screen matches the display, press Enter to go to the next test.

320 X 200 Graphic Display

The next test is the 320 x 200 GRAPHIC DISPLAY (13) test. The test screen displays 16 colored horizontal bars with the name of the color.

Go to the next test by pressing Enter.

Character Sets

The next two tests are character set tests. The first checks that the screen can display characters in a 40 column by 25 row format (the characters are wider than normal).

Graphics Capabilities

The next subtests check the screen's graphic capabilities for each of the computer's graphics modes.

During the test, the resolution and mode number appear above an image representing the mode's capabilities. The number inside the brackets is the mode number.

The next illustration shows the test image for one of the 320 x 200 graphics modes (mode 4).

320*200 GRAPHICS DISPLAY : [4]



PRESS [ENTER] KEY

Graphics capabilities test screen

A similar screen appears for each of the computer's graphics modes.

Press Enter to proceed with the next screens. Each screen has a similar image (three boxes of different shades of gray), differing primarily in resolution. If a different image appears on your screen, contact your dealer. If the screens match the display, press Enter to go to the next test.

Diskette Drives

If you selected the diskette drive test, you see a prompt that asks you to insert a disk into each drive you want to test.

Insert a formatted, write-enabled diskette into each drive(s).



This test may destroy all information on the diskettes. Make sure there is no information you want to keep on the diskettes you use.

To skip this test and return to the diagnostics menu, press Ctrl + Pause.

After you insert the diskette(s) in the drive(s), press Enter. The test begins and displays this message:

FLOPPY DISK IN PROGRESS 503000

If an error occurs, the test displays the ABORTED message. Write down the highlighted numbers and return to the main menu by pressing Ctrl + Pause.

If a diskette drive fails the test, check the following:

- ❖ Does the drive contain a diskette?
- ❖ Is the diskette properly formatted?
- ❖ Is the diskette write-enabled?
- ❖ Is the diskette undamaged?

Repeat the test with another diskette. If the test displays the ABORTED message again, see your dealer.

If the test completes successfully, and you selected the hard disk test, the diagnostic test begins checking the hard disk. If you did not select the hard disk or printer test, the diskette drive test concludes by displaying the TDIAGS screen. To exit TDIAGS, go to “Exiting the Diagnostic Menus” on page 367.

Hard Disk

If the diskette drive(s) test is successful and you selected the hard disk drive test, the hard disk test displays this message:

HARD DISK TEST IN PROGRESS 805100

If an error occurs, the test displays the ABORTED message. Write down all messages and highlighted numbers and consult your dealer. Your computer or your drive may need service. To return to the main menu, press Enter.



The hard disk test does not destroy all of the information stored on the hard disk. However, this test overwrites a small portion of the disk. Back up any important files before you test the hard disk.

If the test completes successfully, and you selected the printer test, the diagnostic test begins the printer test. If you did not select the printer test, the hard disk test concludes by displaying the TDIAGS screen. To exit TDIAGS, go to “Exiting the Diagnostic Menu” on page 367.

Printer

If the hard disk drive tests successfully and you selected to test the printer, the printer test displays this message:

PRINTER TEST IN PROGRESS 60xxxx

where xxxx is a counter that shows the test is still in progress. If you specified an IBM-compatible printer, the test sends the following output to the printer:

```
PRINTER TEST
1. THIS LINE SHOWS NORMAL PRINT.
2. THIS LINE SHOWS DOUBLE WIDTH PRINT.
3. THIS LINE SHOWS COMPRESSED PRINT.
4. THIS LINE SHOWS EMPHASIZED PRINT.
5. THIS LINE SHOWS DOUBLE STRIKE PRINT.
6. ALL CHARACTERS PRINT
```

IBM-compatible printer output

If you specified a non-IBM-compatible printer, the test sends the following output to the printer:

```
!"#$%()*+,-./0123456789:;<=>?@ABCDEFGHIJKLMNopqrstuvwxyz[\]~^_`abcdefghijklmnop  
!"#$%()*+,-./0123456789:;<=>?@ABCDEFGHIJKLMNopqrstuvwxyz[\]~^_`abcdefghijklmnop  
!"#$%()*+,-./0123456789:;<=>?@ABCDEFGHIJKLMNopqrstuvwxyz[\]~^_`abcdefghijklmnop  
!"#$%()*+,-./0123456789:;<=>?@ABCDEFGHIJKLMNopqrstuvwxyz[\]~^_`abcdefghijklmnop  
!"#$%()*+,-./0123456789:;<=>?@ABCDEFGHIJKLMNopqrstuvwxyz[\]~^_`abcdefghijklmnop  
!"#$%()*+,-./0123456789:;<=>?@ABCDEFGHIJKLMNopqrstuvwxyz[\]~^_`abcdefghijklmnop  
!"#$%()*+,-./0123456789:;<=>?@ABCDEFGHIJKLMNopqrstuvwxyz[\]~^_`abcdefghijklmnop  
!"#$%()*+,-./0123456789:;<=>?@ABCDEFGHIJKLMNopqrstuvwxyz[\]~^_`abcdefghijklmnop  
!"#$%()*+,-./0123456789:;<=>?@ABCDEFGHIJKLMNopqrstuvwxyz[\]~^_`abcdefghijklmnop  
!"#$%()*+,-./0123456789:;<=>?@ABCDEFGHIJKLMNopqrstuvwxyz[\]~^_`abcdefghijklmnop
```

Non-IBM-compatible printer output

If an error occurs, the test displays the ABORTED message. Write down all messages and highlighted numbers and check the following items:

- ❖ Is the printer power cord securely plugged into a live wall outlet?
- ❖ Is the printer cable properly connected to the computer?
- ❖ Is the printer turned on?
- ❖ Is the printer ready (on line or selected)?

Run the test. If the test displays the ABORTED message again, or your printout doesn't match the output shown in the illustrations, consult your dealer to have the printer and the cable serviced.

If the printer tests successfully, the test displays the COMPLETED message. Press Enter to return to the TDIAGS screen. To exit TDIAGS, continue with the next section.

Exiting the Diagnostic Menus

To exit the diagnostic menu, follow these steps:

- 1 When TDIAGS completes system components testing, type N and press Enter.**
TDIAGS returns you to the Main menu.
- 2 Remove the Toshiba Companion Diskette from the diskette drive and press Ctrl + Alt + Del or the reset button to restart the computer.**

Features and Specifications

This appendix lists the features of the Satellite 200 Series computer and summarizes its specifications.

Built-in Features

This section lists the Satellite 200 Series features.

Technology and Processor

| | |
|----------------|---|
| Microprocessor | 100 MHz, 2.9 volt/3.3 volt Intel Pentium with 16 KB write-back internal cache. |
| LSI and CMOS | Large Scale Integrated and Complementary Metal-oxide Semiconductor technology, providing minimum size and weight, low-power usage and high reliability. |
| Memory | 3.3-volt, 16 megabit EDO DRAM, delivers high performance with a 60 ns access time, hyperpage mode, 64-bit data bus width. |

Video Graphics Controller Chips & Technologies F65550 SVGA graphics controller with a 32-bit VESA local bus supports BiTBLT accelerator, high-resolution, high-color video modes listed in Appendix D “Video Modes” on page 391; 2 MB VRAM using 5 volt, 60 ns DRAM memory.

ECP The parallel port is an IEEE 1284 8-bit Enhanced Capability Port (ECP-compliant port), providing increased performance when you’re using an ECP-compatible parallel device.

Power

Computer Integrated 30 watt, autosensing AC power supply input voltage: 100-240V AC, 50/60 Hz.

Main Battery Removable, rechargeable Nickel-metal hydride (NiMH) battery pack.

Backup Battery Nickel-metal hydride (NiMH) battery provides power for special memory features, such as Resume Mode.

RTC battery NiMH battery provides power for the internal real-time clock and calendar.

Intelligent power supply Detects low-battery charge and displays the time remaining, in MaxTime.

Automatic power off features Saves battery power by automatically turning off the display, hard disk and system when they have not been accessed for a set length of time.

Storage Capacity

| | |
|----------------------------------|---|
| 3.5-inch external diskette drive | Accommodates both 1.44 MB, high-density (2HD) and 720 KB, double-density (2DD) diskettes. |
| Hard disk | 2.5-inch integrated Enhanced IDE drive and controller provides non-volatile storage for 810 million bytes (722 MB) on all models. |

Ports

| | |
|---------------------|--|
| Parallel | Selectable, ECP-compatible parallel port that provides a Centronics-compatible connection to a printer or other parallel output or bidirectional device. |
| Serial | 9-pin, RS-232-C-compatible, high-speed buffered UART serial port lets you connect an external modem, mouse, serial printer or other serial device. |
| IrDA | Serial infrared port supports 115k transfer rate. |
| Monitor | 15-pin, analog SVGA port lets you connect an external VGA or SVGA monitor (color or monochrome). |
| Keyboard-PS/2 mouse | PS/2-compatible port allows you to connect a 101/102-key keyboard or a PS/2 mouse. |

| | |
|------------------------------|--|
| NoteDock™ | This 176-pin port supports an optional NoteDock that contains a number of ports and two PC card slots, and supports an ID function for use with Windows 95. When customizing multiple docking configurations, Windows 95 is able to identify the connected unit. |
| External diskette drive port | Lets you connect the external 3.5-inch diskette drive. This drive can only be used if there is no diskette drive installed in the SelectBay. |
| Microphone jack | This 3.5 mm jack supports an external monaural microphone or other audio input device. |
| Headphone jack | This 3.5 mm jack lets you connect stereo headphones or other audio output device, such as external speakers. |
| Line-in jack | The 3.5 mm Line-in jack lets you play and record stereo sound from an external audio device, such as a stereo system. |

Standard Hardware

| | |
|---------|--|
| Memory | The standard memory is 8 MB, 3.3 volt, 16-megabit EDO (Extended Data Output) dynamic RAM chips. Can be expanded to 40 MB. |
| Display | The CDS Models have an 11.3-inch (measured diagonally) dual scan, DSTN color LCD that displays up to 64K colors simultaneously at 800 by 600 resolution. |

| | |
|-----------------------|---|
| Keyboard | The enhanced 82-key (84-key in Europe) keyboard emulates the IBM PS/2 keyboard and includes embedded numeric and cursor control overlays and dedicated cursor control keys. |
| Sound | ESS Technologies ES688, Yamaha OPL3 (YMF262), and Yamaha D/A converter (YAC512) are compatible with SoundBlaster Pro. |
| AccuPoint and buttons | These provide the functions of a mouse or other pointing device from the keyboard. |
| CD-ROM drive | The integrated, modular, 5.25-inch 6x speed CD-ROM drive is MPC-compliant, photo-CD capable and lets you run programs from CD-ROMs (compact discs). |

Standard Software

| | |
|------------------------|--|
| Operating System | Microsoft Windows 95 with SVGA drivers and the MaxTime power management program. |
| Configuration Programs | Hardware Setup and TSETUP let you change configuration options and set preferences. |
| Power | APM and MaxTime monitor the battery charge and provide access to the computer's power-saving features. |
| Sound | ESS Audio software. |
| CD-ROM Management | The magiCDisc lets you keep track of CD-ROMs you've used on your computer. |

| | |
|-----------------------------------|---|
| File Transfer and Remote Printing | TranXit program lets you transmit files or print to another computer via the serial, parallel or infrared port. |
| Faxing and Telecommunications | Microsoft Fax and Hyperterminal (Windows 95). |

Special Features

| | |
|---------------------------|--|
| Resume Mode | Electronic bookmark that records what you're doing when you turn the computer off and returns you to the same place when you turn the power back on. |
| Advanced Power Management | Determines the system's power needs and automatically configures the computer for maximum power savings. |
| Security | Instant and power-on passwords help protect your files. |

Documentation

| | |
|--------------------------|---|
| User's Guide | Explains how to set up the computer, gives instructions for basic computing tasks and documents all system components and features. |
| Electronic Documentation | Provides an easy-to-use version of the <i>Satellite 200 Series User's Guide</i> in hypertext form. Load this manual into memory whenever you have questions about the computer. |

Microsoft Windows 95 documentation Documents the Windows 95 operating system

Optional Accessories and Devices

This section lists the options available for the Satellite 200 Series computer.

Power Devices

| | |
|--------------------------|--|
| Battery charger | Charges extra battery packs. |
| Additional battery packs | When an AC wall outlet is not available, use spare or replacement packs to extend the time you can operate the computer. |

Memory Cards

| | |
|-------|---|
| 8 MB | Expands the computer's memory to 16 MB. |
| 16 MB | Expands the computer's memory to 24 MB. |
| 32 MB | Expands the computer's memory to 40 MB. |

Expansion Capability

| | |
|--------------|---|
| PC card slot | Lets you install one Type III or up to two Type I or Type II PC cards. Maximum slot thickness: 10.5 mm. |
|--------------|---|

| | |
|-------------------------|---|
| NoteDock™ (optional) | Optional docking station that provides access to the following: headphone jack, external diskette drive port, PS/2 mouse port, PS/2 keyboard port, two type III PC card slots, audio line-in jack, audio line out jack, serial port, video port, parallel port, MIDI/joystick port, AC in and security lock slot. |
|-------------------------|---|

Others

| | |
|-----------------------------|---|
| Carrying case (optional) | Sturdy fabric or leather carrying case protects the computer while traveling. |
|-----------------------------|---|

Security

| | |
|------------------|---|
| Cable (optional) | Noteworthy Computer Lock cable to deter computer theft. |
|------------------|---|

Specifications

Physical Dimensions

| | |
|--------|--|
| Weight | 7.9 lbs (3.54 kilograms) with CD-ROM drive. 7.5 lbs (3.40 kilograms) with diskette drive. |
| Size | Width x depth x height 11.8 in. x 9.3 in. x 2.2 in. (299 mm x 235 mm x 55 mm) |

Power Cord Connectors

The Satellite 200 Series computer features a universal power supply you can use worldwide. This appendix shows the shapes of the typical AC power cord connectors for various parts of the world.

USA and Canada

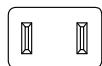

UL approved
CSA approved

United Kingdom



BS approved

Australia



AS approved

Europe



VDA approved
NEMKO approved

System Resources

This appendix lists the pre-assigned IRQ levels, DMA channels and I/O port addresses.

IRQ Level Assignments

The direct line to the CPU is called an Interrupt ReQuest (IRQ) level or channel. You'll hear both terms used by technical experts. They mean the same thing. The following table lists the IRQ level assignments for the Satellite 200 Series computer:

| <i>IRQ</i> | <i>Use</i> | <i>Notes</i> |
|------------|------------|--------------|
| 0 | Timer | |
| 1 | Keyboard | |
| 2 | PIC #2 | |
| 3 | COM2 | |
| 4 | COM1 | |

| <i>IRQ</i> | <i>Use</i> | <i>Notes</i> |
|------------|--|--|
| 5 | Available | Choice for Sound System, PC card |
| 6 | 3.5-inch diskette drive | |
| 7 | LPT1 | Choice for Sound System (default), ECP, or PC card |
| 8 | Real-time clock | |
| 9 | Software redirect to INT 0Ah | Choice for Sound System, ECP, or PC card |
| 10 | Reserved | Choice for Sound System (default), CD-ROM drive, ECP, or PC card |
| 11 | Reserved | Choice for ECP or PC card |
| 12 | PS/2 Mouse/AccuPoint or PC card | |
| 13 | Numeric Data Processor | |
| 14 | Hard disk, ECP, or PC card | |
| 15 | CD-ROM drive (default if installed), ECP, or PC card | |

DMA Channel Assignments

Direct Memory Access (DMA) allows some devices to transfer data to and from memory at high speeds, without using the CPU. Such devices are each assigned a unique DMA channel. The Satellite 200 Series computer has two DMA controllers with four channels on each controller, a total of eight DMA channels.

The following table lists the Satellite 200 Series computer's DMA channel assignments.

| <i>DMA</i> | <i>Use</i> | <i>Notes</i> |
|------------|---------------------------------|--|
| 0 | Reserved | Choice for Sound System |
| 1 | Reserved | This is the Sound System default, or ECP |
| 2 | 3.5-inch diskette drive, or ECP | |
| 3 | Reserved | Choice for Sound or ECP (default) |
| 4 | Cascade from DMAC 1 | |
| 5 | Reserved | |
| 6 | Reserved | |
| 7 | Reserved | |

Input/Output Port Address Assignments

The CPU accesses input/output devices, such as modems, by reading from them or writing to them. Each command to read or write must specify the address (in memory) for the port. Each device that communicates with the CPU must have a unique I/O port address.

The following table lists the device names and their assigned I/O port addresses for the Satellite 200 Series computer.

| <i>Port Address(h)</i> | <i>Device/Function</i> | <i>Notes</i> |
|------------------------|------------------------|--------------|
| 000-01F | 82C37: DMA Controller | 1 |

| <i>Port Address(h)</i> | <i>Device/Function</i> | <i>Notes</i> |
|----------------------------|----------------------------|---|
| 020-03F | 82C59: PIC 1 | |
| 040-05F | 82C54: Timer | |
| 060-06F | Keyboard Controller | 060 and 064 are KBC; 061 is system status port |
| 070 | NMI mask register | |
| 070-07F | Real Time Clock | |
| 080-09F | DMA page register | |
| 0A0-0BF | 82C59: PIC 2 | |
| 0C0-0DF | 82C37: DMA Controller 2 | |
| 0E0-0EF | Special Register | |
| 0F0-0F7 | Math Coprocessor | |
| 100-1EF | VGA | |
| 1F0-1FF | Hard Disk Controller | |
| 201 | Joy Stick | |
| 202-21F | Not used | |
| 220-22F | Not used | Sound System default |
| 230-23F | Not used | Available for Sound System |
| 240-24F | Not used | Available for Sound System |

| <i>Port Address(h)</i> | <i>Device/Function</i> | <i>Notes</i> |
|----------------------------|--|-------------------------------|
| 250-25F | Not used | Available for Sound System |
| 260-277 | Not used | |
| 278-27F | LPT2 | |
| 280-2E7 | Not used | |
| 2E8-2EF | Serial Port or Infrared Port (COM4) | |
| 2F0-2F7 | Not used | |
| 2F8-2FF | Serial Port or Infrared Port (COM2) | |
| 300-33F | Not used | |
| 340-35F | Not used | |
| 360-377 | Not used | |
| 378-37F | LPT1 | |
| 380-387 | Not used | |
| 388-38B | Sound System OPL3 (MIDI) | |
| 38C-38F | Not used | |
| 390-39F | Not used | |
| 3A0-3AF | Bisynchronous 1 | |
| 3B0-3BF | LPT3 | |
| 3C0-3DF | CGA, EGA, VGA, | |

| <i>Port Address(h)</i> | <i>Device/Function</i> | <i>Notes</i> |
|----------------------------|-------------------------------------|---|
| 3E0-3E7 | Not used | |
| 3F0-3F7 | 3.5-inch diskette drive controller | I/O ports 3F6 and 3F7 are used for the HDC also |
| 3E8-3EF | Serial Port or Infrared Port (COM3) | |
| 3F8-3FF | Serial Port or Infrared Port (COM1) | |
| 400-47F | Not used | |
| 480-49F | DMA High-Page Register | |

Video Modes

This appendix lists the video modes supported by the Satellite 200 Series display adapter, and identifies the characteristics of each mode.

The columns of the following tables are defined as follows:

Mode is the mode number in hexadecimal, and is generally used by programmers to specify video modes in programs.

Type identifies the display adapter that first supported the mode, and specifies whether the mode is text or graphics.

Resolution is the measure of the screen's dimensions in terms of horizontal and vertical pixels (in graphics modes), or rows and columns of characters (in text modes).

Grid is the default number of pels per character.

LCD Colors is the maximum number of simultaneous colors, or shades of gray, that the mode can display on the built-in screen.

CRT Colors is the maximum number of simultaneous colors, or shades of gray, that the mode can display on an external monitor.

Scan Freq hor/vert is the horizontal and vertical scanning frequency in Hertz. This is for external monitors only.

Video Modes

This table lists the video modes for the Satellite 200 Series computers.



NOTE

640 by 480 modes will not use the entire area of the built-in display. In DOS, there will be a blank band at the upper and lower edges of the screen using these modes.

| Mode (hex) | Type | Resolution | Internal LCD | | External Monitor | | Scan Freq hor/vert |
|------------|-----------|------------|----------------|---------|------------------|---------|--------------------|
| | | | Grid (pelxpel) | Colors | Grid (pelxpel) | Colors | |
| 0, 1 | VGA Text | 40 x 25 | 8 x 8 | 16/222K | 8 x 8 | 16/256K | 31.5KHz/70Hz |
| 2, 3 | VGA Text | 80 x 25 | 8 x 8 | 16/222K | 8 x 8 | 16/256K | 31.5KHz/70Hz |
| 0*, 1* | VGA Text | 40 x 25 | 8 x 14 | 16/222K | 8 x 14 | 16/256K | 31.5KHz/70Hz |
| 2*, 3* | VGA Text | 80 x 25 | 8 x 14 | 16/222K | 8 x 14 | 16/256K | 31.5KHz/70Hz |
| 0+, 1+ | VGA Text | 40 x 25 | 8(9) x 16 | 16/222K | 9 x 16 | 16/256K | 31.5KHz/70Hz |
| 2+, 3+ | VGA Text | 80 x 25 | 8(9) x 16 | 16/222K | 9 x 16 | 16/256K | 31.5KHz/70Hz |
| 4, 5 | VGA Graph | 320 x 200 | 8 x 8 | 4/222K | 8 x 8 | 4/256K | 31.5KHz/70Hz |
| 6 | VGA Graph | 640 x 200 | 8 x 8 | 2/222K | 8 x 8 | 2/256K | 31.5KHz/70Hz |
| 7 | VGA Text | 80 x 25 | 8(9) x 14 | Mono | 9 x 14 | Mono | 31.5KHz/70Hz |
| 7+ | VGA Text | 80 x 25 | 8(9) x 16 | Mono | 9 x 16 | Mono | 31.5KHz/70Hz |
| D | VGA Graph | 320 x 200 | 8 x 8 | 16/222K | 8 x 8 | 16/256K | 31.5KHz/70Hz |
| E | VGA Graph | 640 x 200 | 8 x 8 | 16/222K | 8 x 8 | 16/256K | 31.5KHz/70Hz |
| F | VGA Graph | 640 x 350 | 8 x 14 | Mono | 8 x 14 | Mono | 31.5KHz/70Hz |

| Mode (hex) | Type | Resolution | Internal LCD | | External Monitor | | Scan Freq hor/vert |
|---------------|---------------|----------------|-------------------|----------|-------------------|----------|---|
| | | | Grid (pelspel) | Colors | Grid (pelspel) | Colors | |
| 10 | VGA Graph | 640 x 350 | 8 x 14 | 16/222K | 8 x 14 | 16/256K | 31.5KHz/70Hz |
| 11 | VGA Graph | 640 x 480 | 8 x 16 | 2/222K | 8 x 16 | 2/256K | 31.5KHz/60Hz |
| 12 | VGA Graph | 640 x 480 | 8 x 16 | 16/222K | 8 x 16 | 16/256K | 31.5KHz/60Hz |
| 13 | VGA Graph | 320 x 200 | 8 x 8 | 256/222K | 8 x 8 | 256/256K | 31.5KHz/70Hz |
| 20 | SVGA Graph | 640 x 480 | 8 x 16 | 16/222K | 8 x 16 | 16/256K | 31.5KHz/60Hz 37.9KHz/72Hz 37.5KHz/75Hz |
| 22 | SVGA Graph | 800 x 600 | 8 x 8 | 16/222K | 8 x 8 | 16/256K | 37.9KHz/60Hz 48.1KHz/72Hz 46.9KHz/75Hz |
| 24 | SVGA Graph | 1024 x 768 | 8 x 16 | 16/222K | 8 x 16 | 16/256K | 35.5KHz/87Hz ⁺ 48.4KHz/60Hz 57.5KHz/70Hz 60.0KHz/75Hz |
| 28 | SVGA Graph | 1280 x 1024 | 8 x 16 | 16/222K | 8 x 16 | 16/256K | 35.5KHz/ 60Hz ⁺ |
| 30 | SVGA Graph | 640 x 480 | 8 x 16 | 256/222K | 8 x 16 | 256/256K | 31.5KHz/60Hz 37.9KHz/72Hz 37.5KHz/75Hz |
| 32 | SVGA Graph | 800 x 600 | 8 x 16 | 256/222K | 8 x 16 | 256/256K | 37.9KHz/60Hz 48.1KHz/72Hz 46.9KHz/75Hz |
| 34 | SVGA Graph | 1024 x 768 | 8 x 16 | 256/222K | 8 x 16 | 256/256K | 35.5KHz/87Hz ⁺ 48.4KHz/60Hz 57.5KHz/70Hz 60.0KHz/75Hz |
| 38 | SVGA Graph | 1280 x 1024 | 8 x 16 | 256/222K | 8 x 16 | 256/256K | 35.5KHz/87Hz ⁺ |
| 40 | SVGA Graph | 640 x 480 | N/A | N/A | 8 x 16 | 32K/32K | 31.5KHz/60Hz 72KHz/37.9Hz 75KHz/37.5Hz |
| 41 | SVGA Graph | 640 x 480 | N/A | N/A | 8 x 16 | 64K/64K | 31.5KHz/60Hz 72KHz/37.9Hz 75KHz/37.5Hz |

394 *Video Modes*

| <i>Mode (hex)</i> | <i>Type</i> | <i>Resolution</i> | <i>Internal LCD</i> | | <i>External Monitor</i> | | <i>Scan Freq hor/vert</i> |
|-----------------------|---------------|-------------------|---------------------------|---------------|---------------------------|---------------|-------------------------------|
| | | | <i>Grid (pelxpel)</i> | <i>Colors</i> | <i>Grid (pelxpel)</i> | <i>Colors</i> | |
| 42 | SVGA Graph | 800 x 600 | 8 x 16 | N/A | 8 x 16 | 32K/32K | 37.9KHz/60Hz |
| 43 | SVGA Graph | 800 x 600 | 8 x 16 | N/A | 8 x 16 | 64k/64k | 37.9KHz/60Hz |
| 44 | SVGA Graph | 1024 x 768 | 8 x 16 | 32K/32K | 8 x 16 | 32K/32K | 48.5KHz/ 60Hz ⁺ |
| 45 | SVGA Graph | 1024 x 768 | 8 x 16 | 64K/64K | 8 x 16 | 64K/64K | 48.5KHz/ 60Hz ⁺ |
| 50 | SVGA Graph | 640 x 480 | 8 x 16 | N/A | 8 x 16 | 16M/16M | 31.5KHz/60Hz |
| 52 | SVGA Graph | 800 x 600 | 8 x 16 | 16M/16M | 8 x 16 | 16M/16M | 37.9KHz/60Hz |

⁺ These modes are interlaced. All others are non-interlaced.

Using Windows for Workgroups

If you selected Windows for Workgroups when you first started your computer, it may seem that there is nothing in this manual for you. This is not the case. Many of the instructions for Windows 95 procedures are very similar to those you use in Windows for Workgroups.

This appendix tells you how to carry out procedures described in this manual if you're using Windows for Workgroups.

Using Windows for Workgroups

This section gives a brief introduction to Windows for Workgroups. For more information, click Help, then click Contents to access online help.

Starting Windows for Workgroups

When you turn your computer on it loads the MS-DOS operating system and displays the command prompt (for example, C:\>). To start Windows for Workgroups, type `c:\windows\win` and press Enter.

Windows for Workgroups loads and displays the Program Manager window.

What's on the Screen?

Program Manager is the gateway to your programs and all the other features of Windows for Workgroups. This section describes the features of Program Manager. Many of these features, such as the menu bar and minimize button, are also present in other programs you run under Windows for Workgroups.

When you start Windows for Workgroups, you see a screen similar to the following:

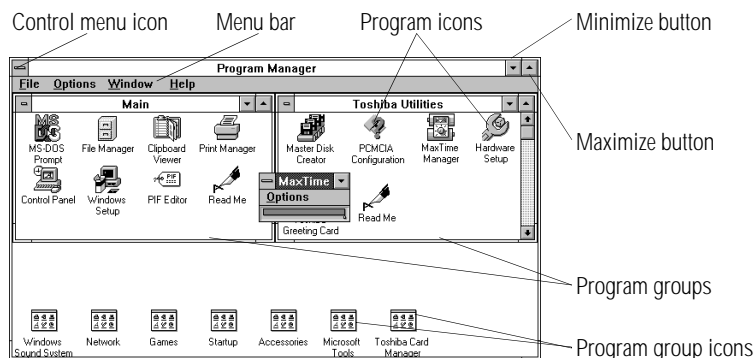

The Program Manager window

- ❖ Clicking the **control menu icon** opens the control menu. This menu lets you set features such as the size and shape of the current window. Double-clicking this icon closes the current window.
- ❖ Clicking one of the words on the **menu bar** opens a list of related activities.
- ❖ Clicking the **minimize button** reduces the current window to an icon. The program in the window is still running—it just moved out of the way to make room for other windows.
- ❖ Clicking the **maximize button** expands the current window to take up the entire screen. When a program is maximized, the maximize button changes to a double arrow called the restore button. Click the restore button to return the window to its original size.

- ❖ Double-clicking a **program icon** starts the program represented by the icon.
- ❖ **Program groups** contain one or more icons representing related programs. For example, the Toshiba Utilities program group contains Toshiba programs, such as MaxTime and Hardware Setup.
- ❖ Double-clicking a **program group icon** opens the program group represented by the icon.

There is no close button in Windows for Workgroups.

Starting Programs

To start a program in Windows for Workgroups, double-click its icon in Program Manager.

If the program doesn't have a Program Manager icon, you have the following two choices:

- ❖ In Program Manager, click File, then click Run. Type in the name of your program file or click Browse to locate the program file, then click OK.
- ❖ In File Manager, double-click the icon for the program file. See the next section for information about File Manager.

Working with Files

You use File Manager to copy and move files, and to perform other file operations in Windows for Workgroups. To start File Manager, double-click the File Manager icon in Program Manager's Main program group.

For information about using File Manager, click Help, then click Contents. Type in the subject you wish to explore, or browse through the list of topics provided.

Running Programs Described in the Guide

This guide describes a number of programs that come with your computer. Using these programs under Windows for Workgroups

is almost the same as using them under Windows 95. This section lists each of the programs, describes the differences between the Windows 95 and Windows for Workgroups versions and points to the instructions for using them.

Master Disk Creator

Master Disk Creator works as described in “Running Master Disk Creator” on page 37 with the following exceptions:

- ❖ Master Disk Creator also creates program disks for Windows for Workgroups. There is no Windows for Workgroups equivalent for Microsoft’s Windows 95 Create System Disks program.
- ❖ To start Master Disk Creator, double-click the Master Disk Creator icon in Program Manager’s Toshiba Utilities program group.

MaxTime

MaxTime opens automatically each time you start Windows for Workgroups. If MaxTime is not already open, double-click the MaxTime icon in Program Manager’s Toshiba Utilities program group.

Once you’ve opened MaxTime, it operates as described throughout this manual. The following table lists where to look for information about specific MaxTime tasks.

| | |
|--|--|
| Monitoring battery power | See “Monitoring Battery Power” on page 124. |
| Setting Resume Mode | See “Starting Again Where You Left Off” on page 133. |
| Setting the battery-save mode and power-saving options | See “Conserving Power” on page 138. |
| Overview of all of MaxTime’s features | See “MaxTime” on page 311. |

Hardware Setup

To start Hardware Setup, double-click the Hardware Setup icon in Program Manager's Toshiba Utilities program group.

Once you've opened Hardware Setup, it operates as described throughout this manual, with one exception. Windows for Workgroups doesn't have Device Manager. Use Hardware Setup to set all options on the Serial, Parallel/Printer, Display and Sound System pages. The following table lists where to look for information about specific Hardware Setup tasks.

| | |
|--|--|
| Creating an Fn key on an external keyboard | See "Making Your External Keyboard Pretend it Has the Fn Key" on page 216. |
| Directing display output at system startup | See "Directing the Display When You Turn the Computer On" on page 212. |
| Setting up a PS/2 mouse | See "Using a PS/2 Mouse" on page 220. |
| Using user-level passwords | See "Working with User-Level Passwords" on page 230. |
| Selecting an alternate keyboard layout | See "Selecting the Keyboard Layout" on page 251. |
| Overview of all Hardware Setup's features | See "Hardware Setup" on page 327. |

TSETUP

To open TSETUP, follow these steps:

- 1 Close any programs you are running and exit Windows, if it's open.**



Run TSETUP outside of Windows, at a system prompt. If you run TSETUP from an MS-DOS session under Windows by clicking the MS-DOS prompt icon, results can be unpredictable.

- 2 At the system prompt, type `c:\dos\tsetup` and press Enter.**

Once you've opened TSETUP, it operates as described in "TSETUP" on page 341.

Fn-esse

To open Fn-esse, double-click the Fn-esse icon in Program Manager's Toshiba Utilities program group. Once you've opened Fn-esse, it operates as described in "Starting Programs Faster" on page 241, except as follows.

When you're using Fn-esse under Windows for Workgroups, there is no Application Explorer dialog box. Instead, you may select a program in the ProgMan Browser dialog box. To use this box to assign a key to a program or document, follow these steps:

- 1 Click the desired key in the Fn-esse keyboard with the secondary button.**

Fn-esse displays the Assignment Type dialog box.

- 2 Click direct.**

Fn-esse displays the Add/Edit Command dialog box.

- 3 Click ProgMan.**

Fn-esse displays the ProgMan Browser dialog box.

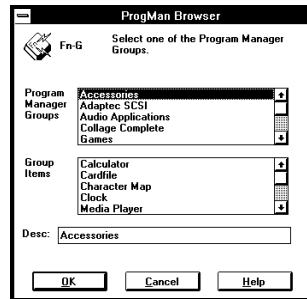

The ProgMan Browser dialog box

- 4 Select the desired program group in the Program Manager Groups window.**
- 5 Select the desired Group Item and click OK.**

Fn-esse displays the Add/Edit Command dialog box again with everything filled in to reflect your choice.

- 6 Click OK.**

magiCDisc

To open magiCDisc, double-click the magiCDisc icon in Program Manager's Toshiba Utilities program group. Once you've opened magiCDisc, it operates as described in "Managing Your CD-ROMs" on page 160.

Turning the Power Off

This section describes different ways to turn the computer off.

Using Resume Mode

This guide describes two ways for you to turn the computer off and return to work in the same place: the Suspend Command and Resume Mode. The Suspend Command is a feature of Windows 95. Use Resume mode instead. You can turn Resume Mode on in any of the ways described in this guide: MaxTime, a hotkey or TSETUP.

Turning the Computer Off

When you're ready to turn the computer off, assuming Resume Mode isn't turned on, follow these steps:

- 1 Save your files and close any programs you're using.**
 - 2 In Program Manager, press Alt + F4 to exit Windows.**
 - 3 Wait for MS-DOS to display the command prompt.**
-



Always wait until you see the command prompt before you turn the computer off. You may see unpredictable results the next time you start Windows if you don't let it shut down completely.

- 4 Turn the computer off.**

Using Optional Devices in Windows for Workgroups

Windows for Workgroups does not support the plug-and-play standard described for Windows 95. This means that when you connect an optional device, such as a PC Card, you'll need to set it up yourself. This section provides information you'll need to use optional devices with Windows for Workgroups.

Using PC Cards

"Little Cards That Do Big Things" on page 173 describes the programs required to use PC Cards. These programs are part of Windows 95.

For Windows for Workgroups, CardWizard provides the Card and Socket Services programs you need to use PC Cards on your sys-

tem. See the CardWizard documentation for instructions for setting up PC Card support.



These programs were specifically designed for your Toshiba computer. Even if your PC Card comes with its own Card and Socket Services programs, try the programs included with your computer first.

Resolving Resource Conflicts

If you add a device that uses the resources already assigned to another device your system stops working and you must resolve the resource conflict. For an introduction to the resources used by the system, see “Resolving Hardware Conflicts on Your Own” on page 278.

Make a list all the resources used by your optional devices. The documentation for each device will tell you how to determine these.

Once your list is complete, check it against the lists in “System Resources” on page 383. Make sure that none of your optional devices conflict with the preset system assignments.

If you can't locate the source of the conflict, remove all optional devices and add them one at a time, checking after each to see if the conflict reappears.

Getting Help

Your computer comes with an electronic book that documents Windows for Workgroups. It is called *Windows QuickStart 3.11 Edition*. To open this book, follow these steps:

- 1 Open the Toshiba Utilities program group.**
- 2 Double-click the Windows QuickStart 3.11 Edition icon.**

Windows opens the book to the table of contents.

Reading a Selected Topic

To read a section of the *Windows QuickStart 3.11 Edition*:

- ❖ Select a part of the book, click its index tab or click Contents and select the section from the list displayed.
- ❖ To move to the beginning of the table of contents, click Contents.
- ❖ To move up or down in a section, click and drag the scroll box or click the up and down arrows at the right side of the screen.
- ❖ To move forward or backward one section at a time, click the left and right arrow icons at the bottom of the screen.
- ❖ To use the alphabetical index, choose Index and click on a topic name.
- ❖ To get help, choose Help Contents from the Help menu or press F1.

Using Bookmarks

Just as you would with a printed book, you can mark your place with a bookmark.

Creating a New Bookmark

To create (or define) a bookmark, follow these steps:

- 1 Choose Define from the Bookmark menu, or click the yellow bookmark icon in the lower-right corner of the screen.**

The dialog box automatically shows the current chapter in the Bookmark Name field as the default name, and displays a list of currently defined bookmarks.

- 2 Type the name and choose OK.**

If you choose OK without typing a name, the current chapter name becomes the bookmark.

If the name is already assigned to another bookmark, the program displays a message. Type the new bookmark name and choose OK.

The electronic book program creates a consecutively numbered bookmark and places it in the text at the upper edge of the “book.”

To view a marked section, click its assigned bookmark and the program switches to the corresponding text location.

Deleting a Bookmark

To delete a previously defined bookmark, follow these steps:

- 1 Choose Define from the Bookmark menu or click the yellow bookmark icon in the lower-right corner of the screen.**

The program displays the Define Bookmark dialog box, which includes the list of currently defined bookmarks.

- 2 Select the bookmark name you wish to delete.**
- 3 Choose delete and choose OK.**

Using Cross-References

Cross-references, which display as underlined text, allow you to move quickly to sections containing information related to the material in the current section. For example, from the batteries section you can go directly to the MaxTime discussion by clicking the cross reference.

To view a cross-reference, follow these steps:

- 1 Position the pointer over the cross-reference.**

The pointer changes to a pointing hand icon.

- 2 Click the cross-reference.**

The program displays the section containing the information that relates to the cross-reference you selected.

When you have finished reading the cross-referenced material, clicking Go Back returns you to the original topic.

Searching for a Topic

The quick start book has a full-text search feature, which can locate every topic that contains a word or phrase you are looking for. To use the full-text search feature, follow these steps:

1 Choose Search and type the word or phrase in the Search Word field.

You can substitute the last characters in a word with an asterisk (*) to find all the forms of the word. For example, typing **bat***, would find “batch,” “battery,” “batteries,” “battery-powered” and “battery-save.”

2 Choose OK to start the search.

The program displays the list of topics that contain the text.

3 Select the topic to view and choose Go To.

The program displays the topic with the word or phrase highlighted.

To exit the Search Results dialog box, choose Cancel.

To start a new search, choose To Search.

Reinstalling Online Documentation

To restore a deleted or damaged electronic book, use the master program diskette that contains the electronic book files. For more information about master program diskettes, see “Create Master Diskettes or Purchase the CD-ROM” on page 35.

Follow these steps to reinstall the *Windows QuickStart 3.11 Edition*:

1 If your diskette drive is not installed in the SelectBay, connect the external diskette drive or replace the CD-ROM drive with the diskette drive in the SelectBay.

To exchange the drives, see “Swapping Drives in the Select-Bay” on page 104.

- 2 Choose Run from the File menu and type the command line a:\install.**

Windows for Work Groups displays the Run dialog box.

- 3 In the Run dialog box, and choose OK and follow the instructions on the screen to define the location of the files.**

If the directory you choose does not exist, the installation program creates it for you.